

RL

live your light



VENTILATOREN
FANS

2026

| | | | | | |
|--------------|--------------|-------------|--------------|---------------|--------------|
| GÖTEBORG 6 | LUND 8 | RANDERS 9 | HELSINKI 10 | HAMMERFEST 12 | FLEN 13 |
| VOLDA 14 | KASFJORD 16 | KIRUNA 18 | VANSBRO 19 | KERAVA 20 | TAMPERE 22 |
| BORAS 23 | MOSS 24 | PAJALA 25 | SORTLAND 26 | STOCKHOLM 27 | STOCKHOLM 28 |
| SVAERHOLT 30 | LINKÖPING 31 | HOLMSUND 32 | STRALSUND 33 | SKAULO 34 | STRALSUND 36 |
| FARSUND 37 | ROTSUND 38 | MORA 39 | VARPULA 40 | HARSTAD 42 | MUONIO 43 |
| VISBY 44 | HALMSTAD 45 | SAARELA 46 | KURULA 47 | SMILLUM 48 | TRONDHEIM 50 |
| LILLESAND 51 | BIDAR 52 | JOHANNA 53 | OSLO 54 | RENA 56 | BREEZY 57 |
| VIKING 58 | | | | | |

INHALT | CONTENT
VENTILATOREN | FANS

DC MOTOR

Deckenventilatoren mit DC-Motor (Gleichstrom-Elektromotor) sind sehr energiesparend und äußerst zuverlässig. Zudem laufen DC-Ventilatoren außerordentlich leise und sehr gleichmäßig. Sie eignen sich perfekt für Ruhebereiche, z. B. das Schlafzimmer, Kinderzimmer, Lesebereiche und Büros.

Ein weiterer Pluspunkt ist der Vor- und Rückwärtslauf bzw. Sommer- und Winterbetrieb. Im Sommer sollte der Deckenventilator gegen den Uhrzeigersinn gedreht werden, um den Luftstrom direkt nach unten zu leiten, der für eine kühle Brise sorgt. Im Winter muss der Ventilator im Uhrzeigersinn laufen, um einen Aufwind zu erzeugen und die warme Luft im Raum besser zu verteilen.

Ceiling fans with a DC motor (direct current electric motor) are very energy-efficient and extremely reliable. DC fans also run extremely quietly and very smoothly. They are perfect for quiet areas, e.g. bedrooms, children's rooms, reading areas and offices.

Another plus point is the forward and reverse operation or summer and winter operation. In summer, the ceiling fan should be turned anticlockwise to direct the airflow straight downwards, which creates a cool breeze. In winter, the fan must run clockwise to create an updraft and better distribute the warm air in the room.

Sommerbetrieb | Summer operation



Winterbetrieb | Winter operation

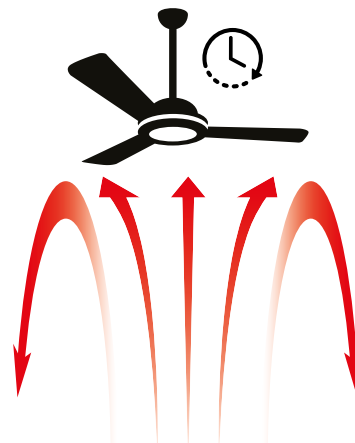

Vorteile DC-Ventilatoren
Advantages of DC fans

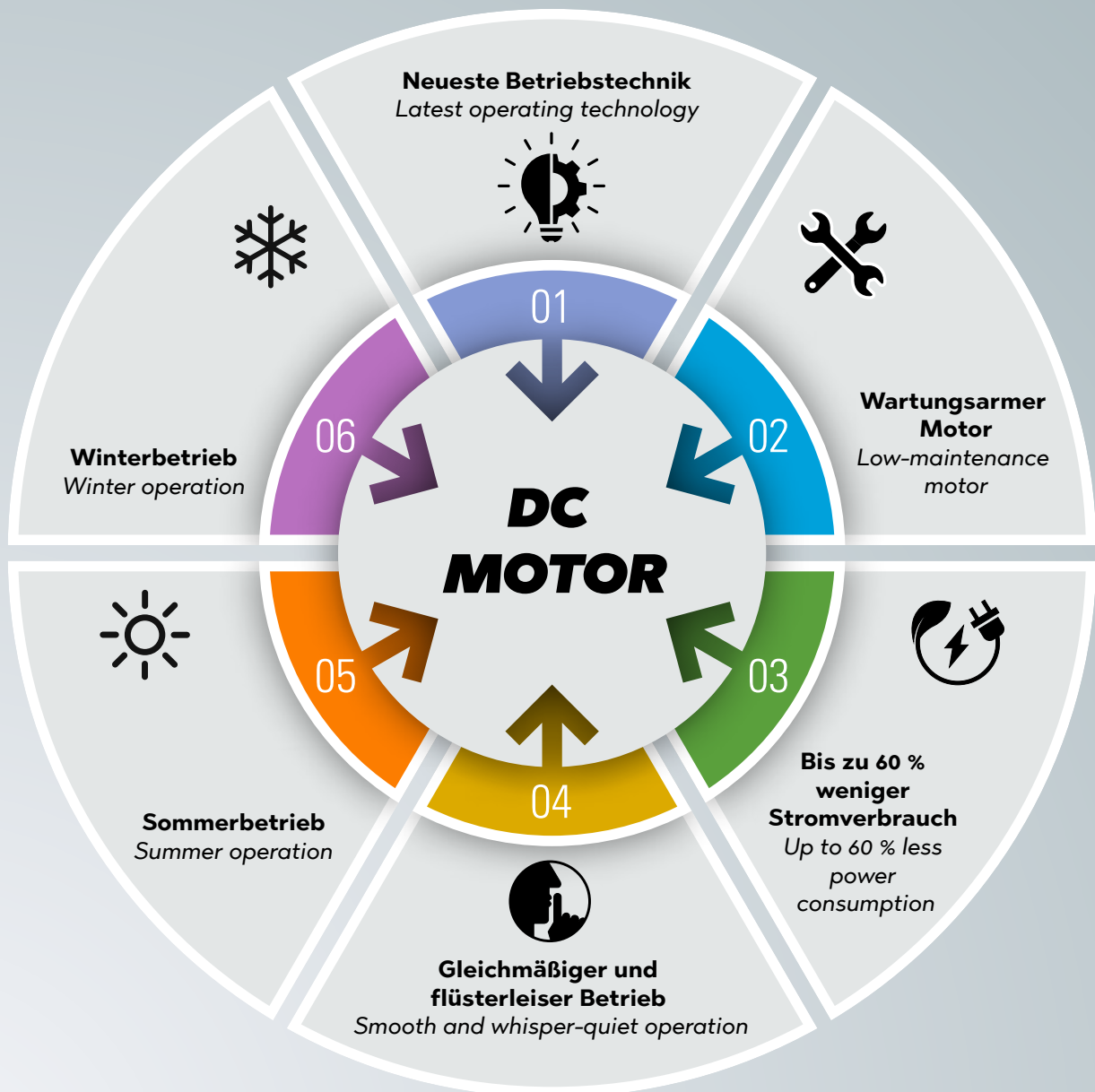

GÖTEBORG



| Level | 1 | 2 | 3 | 4 | 5 | 6 |
|--|-----|-----|-----|------|-----|-----|
| Motor power consumption (W) | 3,5 | 6 | 9 | 14 | 21 | 26 |
| Airflow (m ³ /min) | 78 | 108 | 137 | 162 | 181 | 199 |
| RPM Rotations per minute | 81 | 100 | 120 | 149 | 168 | 180 |
| Service relationship (m ³ /min)/W | 22 | 18 | 15 | 11,5 | 8,6 | 7,6 |
| Sound level (db/A) | 35 | 40 | 43 | 48 | 52 | 55 |
| Maximum air speed (m/s) | | | | | | 1,9 |
| Stand power | 0,4 | | | | | |
| Room size (m ²) | >20 | | | | | |

**DC
MOTOR**

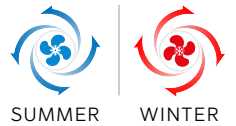

6

Lichtfarbe stufenlos einstellbar / Light colour infinitely variable



2.700 K 6.000 K

| Artikelnummer Art. No | R64202131 | R64202132 |
|------------------------------------|-----------------------|--------------------------|
| Material Material | Kunststoff Plastic | Kunststoff Plastic |
| Farbe Colour | Weiß matt White mat | Schwarz matt Black mat |
| Leuchtmittel Lamps | incl. SMD-LED, 20 W | incl. SMD-LED, 20 W |
| Leuchtenlichtstrom Luminous flux | 2.500 lm | 2.500 lm |
| Lichtfarbe Light colour | 2.700 - 6.000 K | 2.700 - 6.000 K |

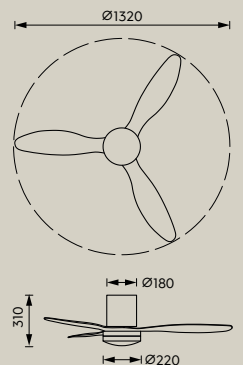



LUND



| Level | 1 | 2 | 3 |
|--|-----|-----|-----|
| Motor power consumption (W) | 6 | 9 | 12 |
| Airflow (m ³ /min) | 22 | 29 | 35 |
| RPM Rotations per minute | 210 | 320 | 450 |
| Service relationship (m ³ /min)/W | 3,6 | 3,2 | 2,9 |
| Sound level (db/A) | 35 | 39 | 45 |
| Maximum air speed (m/s) | | | 2,5 |
| Stand power | 0,4 | | |
| Room size (m ²) | <13 | | |

**DC
MOTOR**

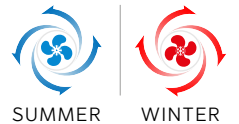

Lichtfarbe stufenlos einstellbar / Light colour infinitely variable



2.700 K 6.500 K

| Artikelnummer Art. No | R67462131 | R67462132 |
|------------------------------------|-----------------------|--------------------------|
| Material Material | Kunststoff Plastic | Kunststoff Plastic |
| Farbe Colour | Weiß matt White mat | Schwarz matt Black mat |
| Leuchtmittel Lamps | incl. SMD-LED, 8 W | incl. SMD-LED, 8 W |
| Leuchtenlichtstrom Luminous flux | 850 lm | 850 lm |
| Lichtfarbe Light colour | 2.700 - 6.500 K | 2.700 - 6.500 K |

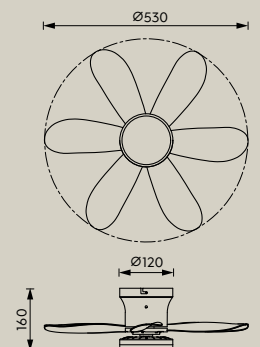

RANDERS



| Level | 1 | 2 | 3 | 4 | 5 | 6 |
|--|-------|------|-----|-----|-----|-----|
| Motor power consumption (W) | 4 | 6 | 9 | 12 | 18 | 29 |
| Airflow (m ³ /min) | 55 | 71 | 84 | 100 | 118 | 137 |
| RPM Rotations per minute | 135 | 168 | 193 | 221 | 253 | 292 |
| Service relationship (m ³ /min)/W | 13,7 | 11,8 | 9,3 | 8,3 | 6,5 | 4,8 |
| Sound level (db/A) | 32 | 36 | 41 | 45 | 50 | 55 |
| Maximum air speed (m/s) | | | | | | 2,2 |
| Stand power | 0,4 | | | | | |
| Room size (m ²) | 13-20 | | | | | |

**DC
MOTOR**



SUMMER

WINTER



Lichtfarbe stufenlos einstellbar / Light colour infinitely variable



2.700 K 6.000 K

| Artikelnummer Art. No | R64412131 | R64412132 |
|------------------------------------|-----------------------|--------------------------|
| Material Material | Kunststoff Plastic | Kunststoff Plastic |
| Farbe Colour | Weiß matt White mat | Schwarz matt Black mat |
| Leuchtmittel Lamps | incl. SMD-LED, 20 W | incl. SMD-LED, 20 W |
| Leuchtenlichtstrom Luminous flux | 2.500 lm | 2.500 lm |
| Lichtfarbe Light colour | 2.700 - 6.000 K | 2.700 - 6.000 K |

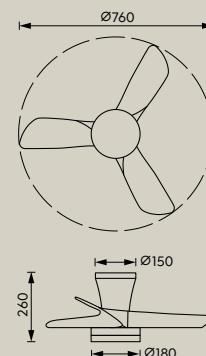

HELSINKI



| Level | 1 | 2 | 3 | 4 | 5 | 6 |
|--|-------|------|-----|-----|-----|-----|
| Motor power consumption (W) | 3,5 | 6 | 8 | 13 | 19 | 29 |
| Airflow (m ³ /min) | 63 | 81 | 97 | 120 | 133 | 146 |
| RPM Rotations per minute | 98 | 121 | 142 | 162 | 185 | 205 |
| Service relationship (m ³ /min)/W | 18 | 13,5 | 12 | 9,2 | 7 | 5 |
| Sound level (db/A) | 33 | 37 | 41 | 45 | 50 | 55 |
| Maximum air speed (m/s) | | | | | | 2,1 |
| Stand power | 0,4 | | | | | |
| Room size (m ²) | 13-20 | | | | | |

**DC
MOTOR**

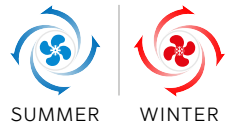

SUMMER WINTER



Lichtfarbe stufenlos einstellbar / Light colour infinitely variable
In der Höhe anpassbar / Adjustable in height



2.700 K 6.000 K

| Artikelnummer Art. No | R62732131 | R62732132 |
|------------------------------------|-----------------------|--------------------------|
| Material Material | Metall Metal | Metall Metal |
| | Kunststoff Plastic | Kunststoff Plastic |
| Farbe Colour | Weiß matt White mat | Schwarz matt Black mat |
| Leuchtmittel Lamps | incl. SMD-LED, 20 W | incl. SMD-LED, 20 W |
| Leuchtenlichtstrom Luminous flux | 2.500 lm | 2.500 lm |
| Lichtfarbe Light colour | 2.700 - 6.000 K | 2.700 - 6.000 K |

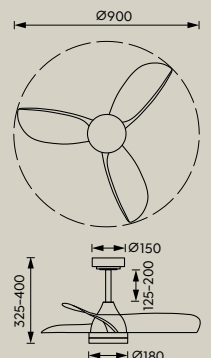



HAMMERFEST



| Level | 1 | 2 | 3 |
|--|-----|-----|-----|
| Motor power consumption (W) | 34 | 37 | 47 |
| Airflow (m ³ /min) | 26 | 57 | 75 |
| RPM Rotations per minute | 0,8 | 1,5 | 1,6 |
| Service relationship (m ³ /min)/W | 40 | 42 | 47 |
| Sound level (db/A) | 0,6 | 1,1 | 1,5 |
| Maximum air speed (m/s) | | | 3,9 |
| Stand power | 0 | | |
| Room size (m ²) | <13 | | |

**AC
MOTOR**

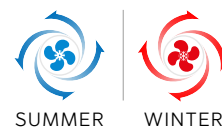

Lichtfarbe stufenlos einstellbar
Light colour infinitely variable



12



| | |
|------------------------------------|------------------------|
| Artikelnummer Art. No | R66592031 |
| Material Material | Metall Metal |
| Farbe Colour | Weiß matt White mat |
| Leuchtmittel Lamps | excl. 1xE27 max. 60 W* |
| Leuchtenlichtstrom Luminous flux | 470 lm |
| Lichtfarbe Light colour | 2.700 K |

*Empfohlen/recommended: **987-400**, Filament LED E27, 4 W, 470 lm, 2.700 K

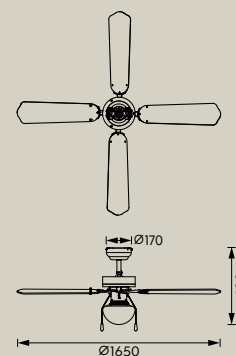

FLEN



| Level | 1 | 2 | 3 | 4 | 5 | 6 |
|--|------|------|-----|-----|------|-----|
| Motor power consumption (W) | 4 | 6 | 9 | 12 | 21,5 | 31 |
| Airflow (m ³ /min) | 52 | 69 | 89 | 105 | 149 | 175 |
| RPM Rotations per minute | 91 | 108 | 128 | 144 | 172 | 196 |
| Service relationship (m ³ /min)/W | 12,4 | 11,3 | 9,9 | 8,7 | 7 | 5,7 |
| Sound level (db/A) | 35 | 39 | 42 | 45 | 49 | 52 |
| Maximum air speed (m/s) | | | | | | 2,8 |
| Stand power | 0,5 | | | | | |
| Room size (m ²) | >20 | | | | | |

**DC
MOTOR**

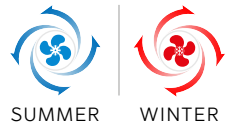

SUMMER WINTER



Lichtfarbe stufenlos einstellbar
Light colour infinitely variable



13



2.700 K 6.000 K

| | |
|------------------------------------|----------------------------|
| Artikelnummer Art. No | R69682130 |
| Material Material | Kunststoff Plastic |
| Farbe Colour | Weiß matt White mat |
| Farbe Colour | Holzfarbig Wood coloured |
| Leuchtmittel Lamps | incl. SMD-LED, 24 W |
| Leuchtenlichtstrom Luminous flux | 2.800 lm |
| Lichtfarbe Light colour | 2.700 - 6.000 K |

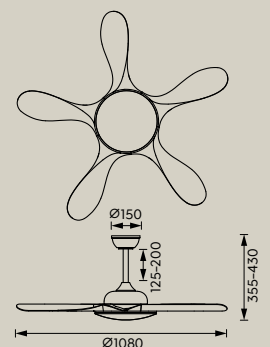

VOLDA



| Level | 1 | 2 | 3 | 4 | 5 | 6 |
|--|-------|------|------|------|------|-----|
| Motor power consumption (W) | 9,8 | 11,8 | 15,4 | 18,9 | 22,8 | 30 |
| Airflow (m ³ /min) | 65 | 72 | 84 | 98 | 109 | 125 |
| RPM Rotations per minute | 188 | 200 | 215 | 226 | 234 | 248 |
| Service relationship (m ³ /min)/W | 6,6 | 6,1 | 5,5 | 5,2 | 4,8 | 4,2 |
| Sound level (db/A) | 28 | 31 | 37 | 41 | 45 | 50 |
| Maximum air speed (m/s) | | | | | | 3,2 |
| Stand power | 0,5 | | | | | |
| Room size (m ²) | 13-20 | | | | | |

DC MOTOR

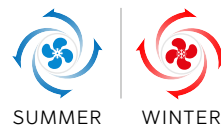

Lichtfarbe stufenlos einstellbar
Light colour infinitely variable



Flügel ein- und ausfahrbar
Retractable/extendable fan blades



14



2.700 K 6.500 K

| Artikelnummer Art. No | R69642101 | R69642107 |
|------------------------------------|----------------------|--------------------------|
| Material Material | Kunststoff Plastic | Kunststoff Plastic |
| Farbe Colour | Weiß White | Nickel matt Nickel mat |
| Leuchtmittel Lamps | incl. SMD-LED, 30 W | incl. SMD-LED, 30 W |
| Leuchtenlichtstrom Luminous flux | 3.500 lm | 3.500 lm |
| Lichtfarbe Light colour | 2.700 - 6.500 K | 2.700 - 6.500 K |

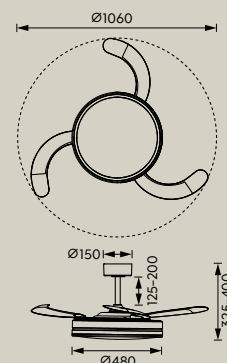





KASFJORD



| Level | 1 | 2 | 3 | 4 | 5 | 6 |
|--|-------|------|------|------|------|-----|
| Motor power consumption (W) | 9,8 | 11,8 | 15,4 | 18,9 | 22,8 | 30 |
| Airflow (m ³ /min) | 65 | 72 | 84 | 98 | 109 | 125 |
| RPM Rotations per minute | 188 | 200 | 215 | 226 | 234 | 248 |
| Service relationship (m ³ /min)/W | 6,6 | 6,1 | 5,5 | 5,2 | 4,8 | 4,2 |
| Sound level (db/A) | 28 | 31 | 37 | 41 | 45 | 49 |
| Maximum air speed (m/s) | | | | | | 2,5 |
| Stand power | 0,5 | | | | | |
| Room size (m ²) | 13-20 | | | | | |

**DC
MOTOR**



SUMMER



WINTER



2.700 K 6.500 K

| Artikelnummer Art. No | R64452131 | R64452132 |
|------------------------------------|-----------------------|--------------------------|
| Material Material | Metall Metal | Metall Metal |
| | Kunststoff Plastic | Kunststoff Plastic |
| Farbe Colour | Weiß matt White mat | Schwarz matt Black mat |
| Leuchtmittel Lamps | incl. SMD-LED, 34 W | incl. SMD-LED, 34 W |
| Leuchtenlichtstrom Luminous flux | 3.700 lm | 3.700 lm |
| Lichtfarbe Light colour | 2.700 - 6.500 K | 2.700 - 6.500 K |

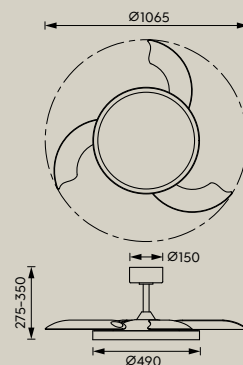

KIRUNA



| Level | 1 | 2 | 3 | 4 | 5 | 6 |
|--|-------|-------|------|------|------|-----|
| Motor power consumption (W) | 5,6 | 7,8 | 10 | 14 | 20 | 25 |
| Airflow (m ³ /min) | 40 | 50 | 59 | 75 | 104 | 120 |
| RPM Rotations per minute | 145 | 170 | 195 | 215 | 230 | 245 |
| Service relationship (m ³ /min)/W | 7,1 | 6,4 | 5,9 | 5,4 | 5,2 | 4,8 |
| Sound level (db/A) | 10,8 | 14,98 | 19,2 | 26,9 | 38,4 | 48 |
| Maximum air speed (m/s) | | | | | | 2,4 |
| Stand power | 0,5 | | | | | |
| Room size (m ²) | 13-20 | | | | | |

**DC
MOTOR**

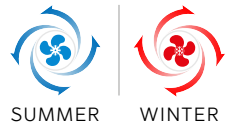

SUMMER WINTER



Starlight Effekt / Lichtfarbe stufenlos einstellbar
Starlight effect / Light colour infinitely variable



Flügel ein- und ausfahrbar
Retractable/extendable fan blades



18



2.700 K 6.500 K

| | |
|------------------------------------|----------------------|
| Artikelnummer Art. No | R69622101 |
| Material Material | Kunststoff Plastic |
| Farbe Colour | Weiß White |
| Leuchtmittel Lamps | incl. SMD-LED, 32 W |
| Leuchtenlichtstrom Luminous flux | 4.000 lm |
| Lichtfarbe Light colour | 2.700 - 6.500 K |

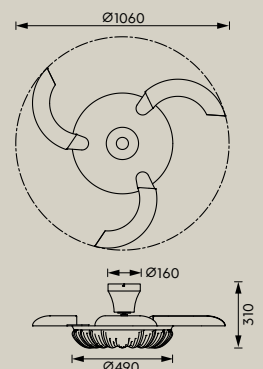

VANSBRO



| Level | 1 | 2 | 3 | 4 | 5 | 6 |
|--|-------|-------|------|------|------|-----|
| Motor power consumption (W) | 5,6 | 7,8 | 10 | 14 | 20 | 25 |
| Airflow (m ³ /min) | 40 | 50 | 59 | 75 | 104 | 120 |
| RPM Rotations per minute | 145 | 170 | 195 | 215 | 230 | 245 |
| Service relationship (m ³ /min)/W | 7,1 | 6,4 | 5,9 | 5,4 | 5,2 | 4,8 |
| Sound level (db/A) | 10,8 | 14,98 | 19,2 | 26,9 | 38,4 | 48 |
| Maximum air speed (m/s) | | | | | | 2,9 |
| Stand power | 0,5 | | | | | |
| Room size (m ²) | 13-20 | | | | | |

**DC
MOTOR**

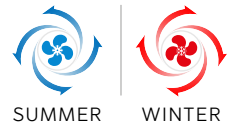

Lichtfarbe stufenlos einstellbar
Light colour infinitely variable



Flügel ein- und ausfahrbar
Retractable/extendable fan blades

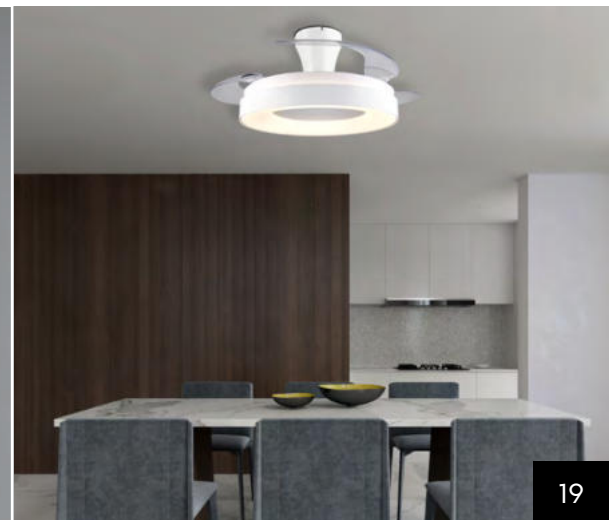

19



2.700 K 6.500 K

| | |
|------------------------------------|-----------------------|
| Artikelnummer Art. No | R69652101 |
| Material Material | Kunststoff Plastic |
| Farbe Colour | Weiß matt White mat |
| Leuchtmittel Lamps | incl. SMD-LED, 32 W |
| Leuchtenlichtstrom Luminous flux | 4.000 lm |
| Lichtfarbe Light colour | 2.700 - 6.500 K |

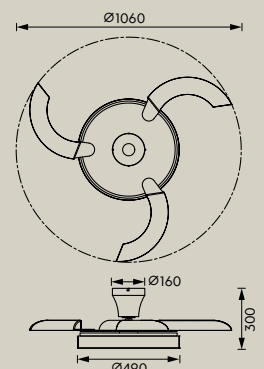

KERAVA



| Level | 1 | 2 | 3 | 4 | 5 | 6 |
|--|-------|------|------|------|------|-----|
| Motor power consumption (W) | 9,8 | 11,8 | 15,4 | 18,9 | 22,8 | 30 |
| Airflow (m ³ /min) | 65 | 72 | 84 | 98 | 109 | 125 |
| RPM Rotations per minute | 188 | 200 | 215 | 226 | 234 | 248 |
| Service relationship (m ³ /min)/W | 6,6 | 6,1 | 5,5 | 5,2 | 4,8 | 4,2 |
| Sound level (db/A) | 28 | 31 | 37 | 41 | 45 | 49 |
| Maximum air speed (m/s) | | | | | | 2,5 |
| Stand power | 0,5 | | | | | |
| Room size (m ²) | 13-20 | | | | | |

**DC
MOTOR**

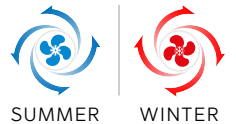

2.700 K 6.500 K

| | |
|------------------------------------|----------------------|
| Artikelnummer Art. No | R69572101 |
| Material Material | Kunststoff Plastic |
| Farbe Colour | Weiß White |
| Leuchtmittel Lamps | incl. SMD-LED, 30 W |
| Leuchtenlichtstrom Luminous flux | 3.500 lm |
| Lichtfarbe Light colour | 2.700 - 6.500 K |

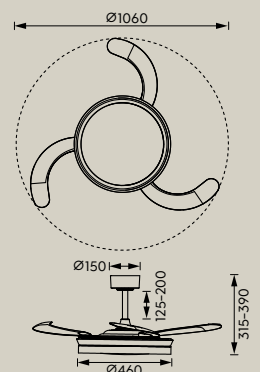



TAMPERE



| Level | 1 | 2 | 3 | 4 | 5 | 6 |
|--|-----|-----|-----|------|------|-----|
| Motor power consumption (W) | 3,8 | 5,8 | 9,9 | 12,9 | 19,5 | 20 |
| Airflow (m ³ /min) | 32 | 45 | 59 | 69 | 92 | 95 |
| RPM Rotations per minute | 170 | 195 | 230 | 280 | 320 | 380 |
| Service relationship (m ³ /min)/W | 8,4 | 7,8 | 6 | 5,3 | 4,7 | 4,7 |
| Sound level (db/A) | 25 | 28 | 32 | 38 | 41 | 47 |
| Maximum air speed (m/s) | | | | | | 2,8 |
| Stand power | 0,5 | | | | | |
| Room size (m ²) | <13 | | | | | |

**DC
MOTOR**

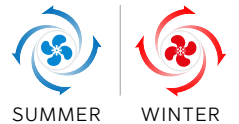

SUMMER WINTER



Mit Wandhalterung
With wall mount



Flügel ein- und ausfahrbar / Lichtfarbe einstellbar
Retractable/extendable fan blades / Light colour variable



2.700 K 6.500 K

| | |
|------------------------------------|----------------------|
| Artikelnummer Art. No | R69532101 |
| Material Material | Kunststoff Plastic |
| Farbe Colour | Weiß White |
| Leuchtmittel Lamps | incl. SMD-LED, 24 W |
| Leuchtenlichtstrom Luminous flux | 2.800 lm |
| Lichtfarbe Light colour | 2.700 - 6.500 K |

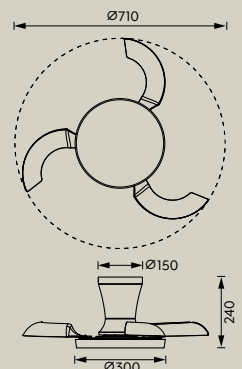

BORAS



| Level | 1 | 2 | 3 | 4 | 5 | 6 |
|--|-------|-----|-----|-----|-----|-----|
| Motor power consumption (W) | 5,6 | 7,8 | 10 | 14 | 20 | 25 |
| Airflow (m ³ /min) | 32 | 42 | 50 | 68 | 92 | 105 |
| RPM Rotations per minute | 180 | 210 | 230 | 290 | 330 | 400 |
| Service relationship (m ³ /min)/W | 5,7 | 5,4 | 5 | 4,8 | 4,6 | 4,2 |
| Sound level (db/A) | 22 | 24 | 27 | 32 | 39 | 46 |
| Maximum air speed (m/s) | | | | | | 2,9 |
| Stand power | 0,5 | | | | | |
| Room size (m ²) | 13-20 | | | | | |

**DC
MOTOR**



Flügel ein- und ausfahrbar / Lichtfarbe stufenlos einstellbar
LiRetractable/extendable fan blades / Light colour infinitely variable



23



2.700 K 6.500 K

| | |
|------------------------------------|-----------------------|
| Artikelnummer Art. No | R69542131 |
| Material Material | Kunststoff Plastic |
| Farbe Colour | Weiß matt White mat |
| Leuchtmittel Lamps | incl. SMD-LED, 24 W |
| Leuchtenlichtstrom Luminous flux | 2.640 lm |
| Lichtfarbe Light colour | 2.700 - 6.500 K |

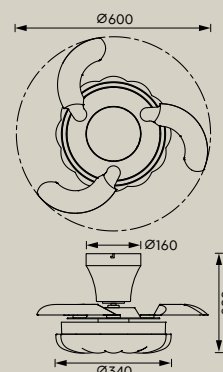

MOSS



| Level | 1 | 2 | 3 | 4 | 5 | 6 |
|--|-----|-----|-----|-----|------|-----|
| Motor power consumption (W) | 3,1 | 3,5 | 4,3 | 7,3 | 11,4 | 15 |
| Airflow (m ³ /min) | 27 | 30 | 35 | 52 | 68 | 79 |
| RPM Rotations per minute | 300 | 350 | 410 | 520 | 580 | 620 |
| Service relationship (m ³ /min)/W | 8,7 | 8,5 | 8,1 | 7,1 | 6 | 5,2 |
| Sound level (db/A) | 29 | 32 | 35 | 38 | 41 | 45 |
| Maximum air speed (m/s) | | | | | | 3,1 |
| Stand power | 0,5 | | | | | |
| Room size (m ²) | <13 | | | | | |

**DC
MOTOR**

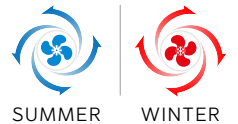

SUMMER WINTER



Lichtfarbe stufenlos einstellbar
Light colour infinitely variable



Flügel ein- und ausfahrbar
Retractable/extendable fan blades



24



2.700 K 6.500 K

| | |
|------------------------------------|----------------------|
| Artikelnummer Art. No | R69512101 |
| Material Material | Kunststoff Plastic |
| Farbe Colour | Weiß White |
| Leuchtmittel Lamps | incl. SMD-LED, 18 W |
| Leuchtenlichtstrom Luminous flux | 2.520 lm |
| Lichtfarbe Light colour | 2.700 - 6.500 K |

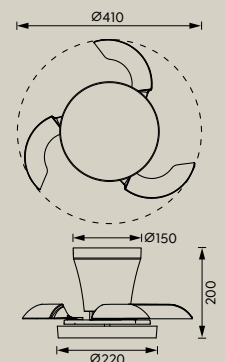

PAJALA



| Level | 1 | 2 | 3 |
|--|-----|-----|-----|
| Motor power consumption (W) | 6 | 10 | 12 |
| Airflow (m ³ /min) | 24 | 31 | 34 |
| RPM Rotations per minute | 620 | 825 | 955 |
| Service relationship (m ³ /min)/W | 4 | 3,1 | 2,8 |
| Sound level (db/A) | 40 | 45 | 53 |
| Maximum air speed (m/s) | | | 4,2 |
| Stand power | 0,5 | | |
| Room size (m ²) | <13 | | |

**DC
MOTOR**

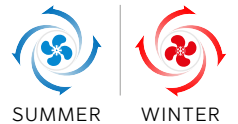

SUMMER WINTER



Lichtfarbe stufenlos einstellbar
Light colour infinitely variable

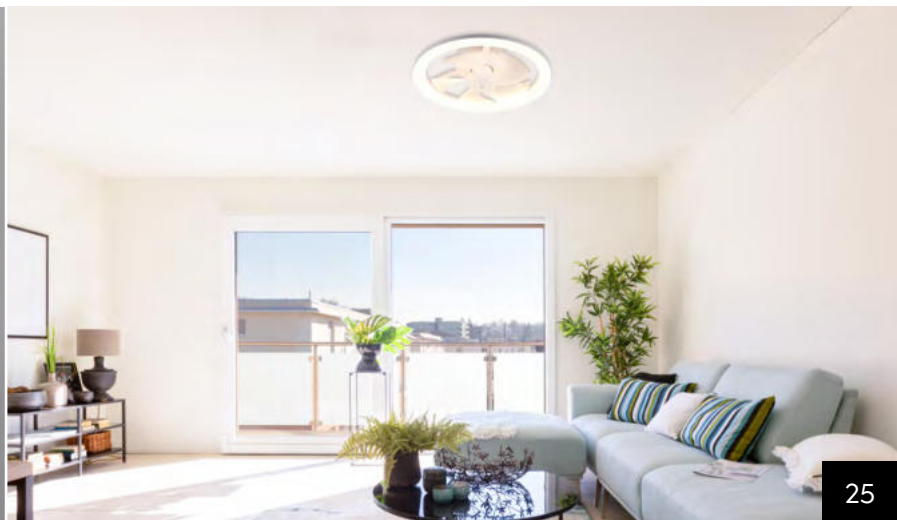

25



2.700 K 6.500 K

| | |
|------------------------------------|-----------------------|
| Artikelnummer Art. No | R69172131 |
| Material Material | Kunststoff Plastic |
| Farbe Colour | Weiß matt White mat |
| Leuchtmittel Lamps | incl. SMD-LED, 22 W |
| Leuchtenlichtstrom Luminous flux | 2.600 lm |
| Lichtfarbe Light colour | 2.700 - 6.500 K |

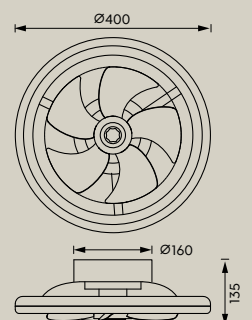

SORTLAND

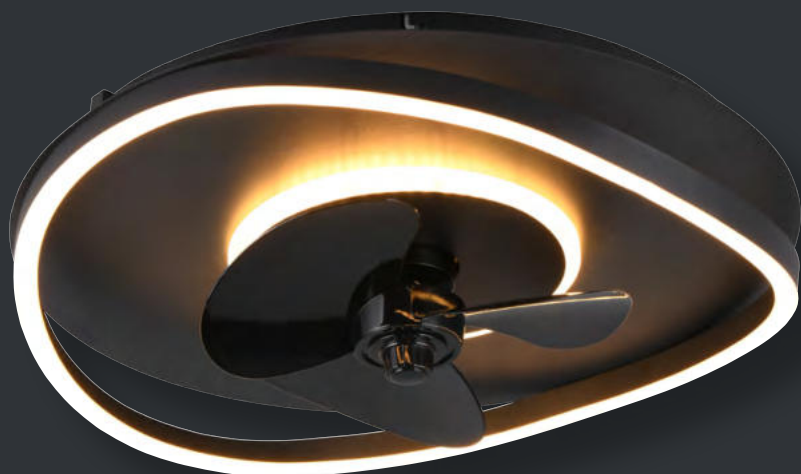

| Level | 1 | 2 | 3 |
|--|-----|------|------|
| Motor power consumption (W) | 5 | 10 | 15 |
| Airflow (m ³ /min) | 19 | 27 | 33 |
| RPM Rotations per minute | 760 | 1040 | 1260 |
| Service relationship (m ³ /min)/W | 3,8 | 2,7 | 2,2 |
| Sound level (db/A) | 42 | 48 | 56 |
| Maximum air speed (m/s) | 0,9 | 1,5 | 1,8 |
| Stand power | 0,5 | | |
| Room size (m ²) | <13 | | |

**DC
MOTOR**



26

Lichtfarbe stufenlos einstellbar / Light colour infinitely variable



2.700 K 6.500 K

| | |
|---|--|
| Artikelnummer Art. No | R67393132 |
| Material Material | Metall Metal Kunststoff Plastic |
| Farbe Colour | Schwarz matt Black mat |
| Leuchtmittel Lamps | incl. SMD-LED, 30 W |
| Leuchtenlichtstrom Luminous flux | 3.500 lm |
| Lichtfarbe Light colour | 2.700 - 6.500 K |

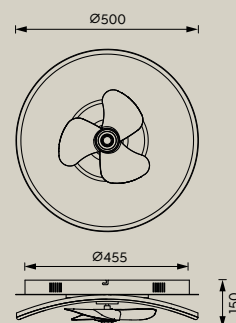

STOCKHOLM



| Level | 1 | 2 | 3 | 4 | 5 | 6 |
|--|------|------|------|------|------|-----|
| Motor power consumption (W) | 4 | 8 | 12 | 16 | 20 | 25 |
| Airflow (m ³ /min) | 42 | 58 | 70 | 76 | 81 | 88 |
| RPM Rotations per minute | 180 | 250 | 300 | 330 | 350 | 380 |
| Service relationship (m ³ /min)/W | 10,5 | 7,2 | 5,8 | 4,7 | 4 | 3,5 |
| Sound level (db/A) | 31 | 35 | 43 | 48 | 50,5 | 54 |
| Maximum air speed (m/s) | 1,4 | 1,72 | 2,04 | 2,36 | 2,68 | 3 |
| Stand power | 0,5 | | | | | |
| Room size (m ²) | <13 | | | | | |

**DC
MOTOR**



Lichtfarbe stufenlos einstellbar
Light colour infinitely variable



27



2.700 K 6.500 K

| Artikelnummer Art. No | R64262131 | R64262132 |
|------------------------------------|-----------------------|--------------------------|
| Material Material | Kunststoff Plastic | Kunststoff Plastic |
| Farbe Colour | Weiß matt White mat | Schwarz matt Black mat |
| Leuchtmittel Lamps | incl. SMD-LED, 37 W | incl. SMD-LED, 37 W |
| Leuchtenlichtstrom Luminous flux | 4.300 lm | 4.300 lm |
| Lichtfarbe Light colour | 2.700 - 6.500 K | 2.700 - 6.500 K |

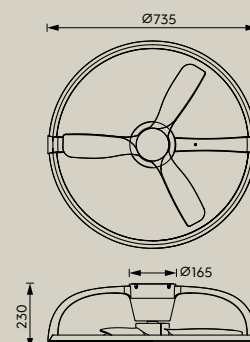

STOCKHOLM



| Level | 1 | 2 | 3 | 4 | 5 | 6 |
|--|------|------|------|------|------|-----|
| Motor power consumption (W) | 4 | 8 | 12 | 16 | 20 | 25 |
| Airflow (m ³ /min) | 42 | 58 | 70 | 76 | 81 | 88 |
| RPM Rotations per minute | 180 | 250 | 300 | 330 | 350 | 380 |
| Service relationship (m ³ /min)/W | 10,5 | 7,2 | 5,8 | 4,7 | 4 | 3,5 |
| Sound level (db/A) | 31 | 35 | 43 | 48 | 50,5 | 54 |
| Maximum air speed (m/s) | 1,4 | 1,72 | 2,04 | 2,36 | 2,68 | 3 |
| Stand power | 0,5 | | | | | |
| Room size (m ²) | <13 | | | | | |

**DC
MOTOR**



28 Lichtfarbe stufenlos einstellbar
Light colour infinitely variable

Dynamic light:
Faszinierende Lichteffekte
Fascinating light effects



2.700 K 6.500 K

| | |
|------------------------------------|--------------------------|
| Artikelnummer Art. No | R64262932 |
| Material Material | Kunststoff Plastic |
| Farbe Colour | Schwarz matt Black mat |
| Leuchtmittel Lamps | incl. SMD-LED, 37 W |
| Leuchtenlichtstrom Luminous flux | 4.500 lm |
| Lichtfarbe Light colour | 2.700 - 6.500 K |

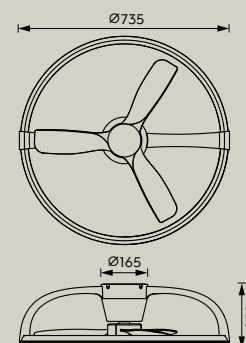



SVAERHOLT



| Level | 1 | 2 | 3 | 4 | 5 |
|--|------|-----|------|------|------|
| Motor power consumption (W) | 5 | 8,5 | 11,5 | 15 | 19 |
| Airflow (m ³ /min) | 26 | 31 | 35 | 39 | 45 |
| RPM Rotations per minute | 640 | 800 | 900 | 1000 | 1080 |
| Service relationship (m ³ /min)/W | 5,2 | 3,6 | 3 | 2,6 | 2,4 |
| Sound level (db/A) | 43 | 48 | 52 | 54 | 56 |
| Maximum air speed (m/s) | 2 | 2,5 | 3 | 3,5 | 4 |
| Stand power | 0,36 | | | | |
| Room size (m ²) | <13 | | | | |

**DC
MOTOR**



Dynamic light:
Faszinierende Lichteffekte
Fascinating light effects



Lichtfarbe stufenlos einstellbar
Light colour infinitely variable



30



2.700 K 6.500 K

| | |
|------------------------------------|------------------------|
| Artikelnummer Art. No | R69302102 |
| Material Material | Kunststoff Plastic |
| Farbe Colour | Schwarz Black |
| Leuchtmittel Lamps | incl. 1x SMD-LED, 34 W |
| Leuchtenlichtstrom Luminous flux | 4.500 lm |
| Lichtfarbe Light colour | 2.700 - 6.500 K |

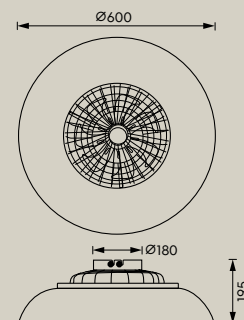

LINKÖPING



| Level | 1 | 2 | 3 |
|--|-----|-----|------|
| Motor power consumption (W) | 6 | 15 | 20 |
| Airflow (m ³ /min) | 21 | 30 | 35 |
| RPM Rotations per minute | 650 | 820 | 1050 |
| Service relationship (m ³ /min)/W | 3,5 | 2,1 | 1,8 |
| Sound level (db/A) | 39 | 46 | 54 |
| Maximum air speed (m/s) | | | 3,8 |
| Stand power | 0,5 | | |
| Room size (m ²) | <13 | | |

**DC
MOTOR**

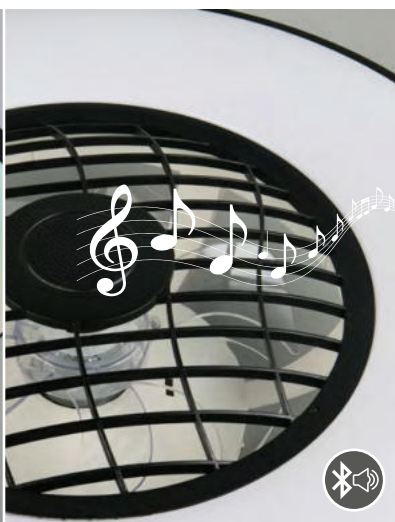

Dynamic light:
Faszinierende Lichteffekte
Fascinating light effects



2.700 K 6.500 K

| | |
|------------------------------------|---------------------------------|
| Artikelnummer Art. No | R64462102 |
| Material Material | Kunststoff Plastic |
| Farbe Colour | Schwarz Black Weiß White |
| Leuchtmittel Lamps | incl. SMD-LED, 45 W |
| Leuchtenlichtstrom Luminous flux | 5.600 lm |
| Lichtfarbe Light colour | 2.700 - 6.500 K |

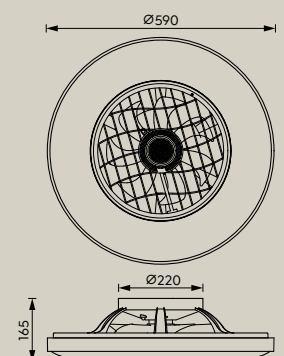

HOLMSUND



| Level | 1 | 2 | 3 |
|--|-----|-----|-----|
| Motor power consumption (W) | 5,5 | 10 | 13 |
| Airflow (m ³ /min) | 22 | 27 | 30 |
| RPM Rotations per minute | 685 | 915 | 990 |
| Service relationship (m ³ /min)/W | 4 | 2,8 | 2,4 |
| Sound level (db/A) | 41 | 45 | 50 |
| Maximum air speed (m/s) | | | 5 |
| Stand power | 0,5 | | |
| Room size (m ²) | <13 | | |

**DC
MOTOR**



SUMMER



Lichtfarbe stufenlos einstellbar
Light colour infinitely variable



Dynamic light:
Faszinierende Lichteffekte
Fascinating light effects



32



3.000 K 6.500 K

| | |
|------------------------------------|------------------------|
| Artikelnummer Art. No | R69282101 |
| Material Material | Kunststoff Plastic |
| Farbe Colour | Weiß White |
| Leuchtmittel Lamps | incl. 1x SMD-LED, 20 W |
| Leuchtenlichtstrom Luminous flux | 2.400 lm |
| Lichtfarbe Light colour | 3.000 - 6.500 K |

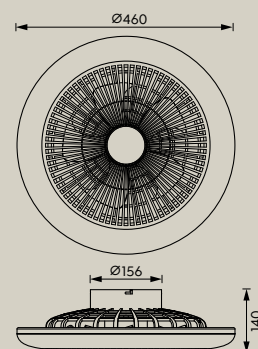

STRALSUND



| Level | 1 | 2 | 3 |
|--|-----|-----|-----|
| Motor power consumption (W) | 6 | 10 | 15 |
| Airflow (m ³ /min) | 25 | 29 | 33 |
| RPM Rotations per minute | 620 | 825 | 955 |
| Service relationship (m ³ /min)/W | 4,1 | 2,9 | 2,2 |
| Sound level (db/A) | 40 | 45 | 53 |
| Maximum air speed (m/s) | | | 3,5 |
| Stand power | 0,5 | | |
| Room size (m ²) | <13 | | |

**DC
MOTOR**



RGBW-Farbwechsler
RGBW Colourchanging
Starlight Effekt / Starlight effect



33



2.700 K 6.500 K

| | |
|------------------------------------|--|
| Artikelnummer Art. No | R62522987 |
| Material Material | Kunststoff Plastic |
| Farbe Colour | Weiß matt White mat Titanfarbig Titan |
| Leuchtmittel Lamps | incl. 1x SMD-LED, 30 W |
| Leuchtenlichtstrom Luminous flux | 3.500 lm |
| Lichtfarbe Light colour | 2.700 - 6.500 K |

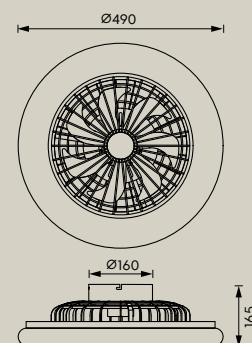



SKAULO



| Level | 1 | 2 | 3 |
|--|-----|------|-----|
| Motor power consumption (W) | 5,8 | 10,1 | 15 |
| Airflow (m ³ /min) | 24 | 29 | 35 |
| RPM Rotations per minute | 620 | 825 | 955 |
| Service relationship (m ³ /min)/W | 4,1 | 2,9 | 2,3 |
| Sound level (db/A) | 40 | 45 | 53 |
| Maximum air speed (m/s) | | | 4,2 |
| Stand power | 0,5 | | |
| Room size (m ²) | <13 | | |

**DC
MOTOR**

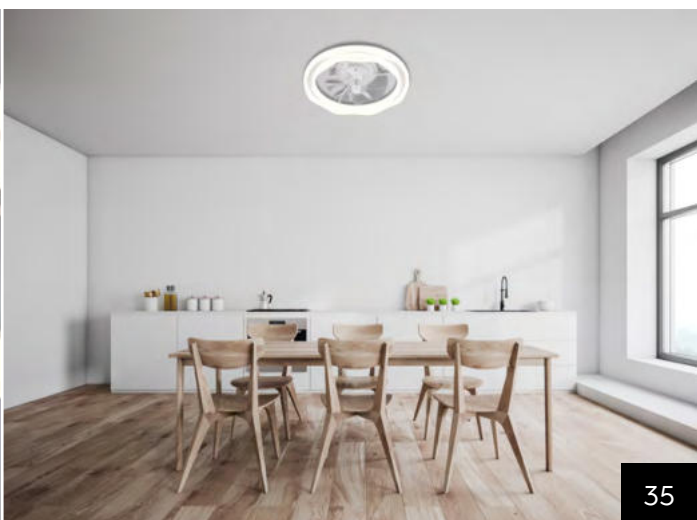

35



2.700 K 6.500 K

| | |
|------------------------------------|----------------------|
| Artikelnummer Art. No | R69192131 |
| Material Material | Kunststoff Plastic |
| Farbe Colour | Weiß White |
| Leuchtmittel Lamps | incl. SMD-LED, 35 W |
| Leuchtenlichtstrom Luminous flux | 4.200 lm |
| Lichtfarbe Light colour | 2.700 - 6.500 K |

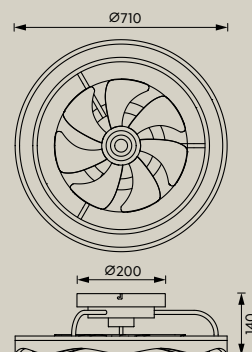

STRALSUND



| Level | 1 | 2 | 3 |
|--|-----|-----|-----|
| Motor power consumption (W) | 6 | 10 | 15 |
| Airflow (m ³ /min) | 25 | 29 | 33 |
| RPM Rotations per minute | 620 | 825 | 955 |
| Service relationship (m ³ /min)/W | 4,1 | 2,9 | 2,2 |
| Sound level (db/A) | 40 | 45 | 53 |
| Maximum air speed (m/s) | | | 3,5 |
| Stand power | 0,5 | | |
| Room size (m ²) | <13 | | |

DC
MOTOR

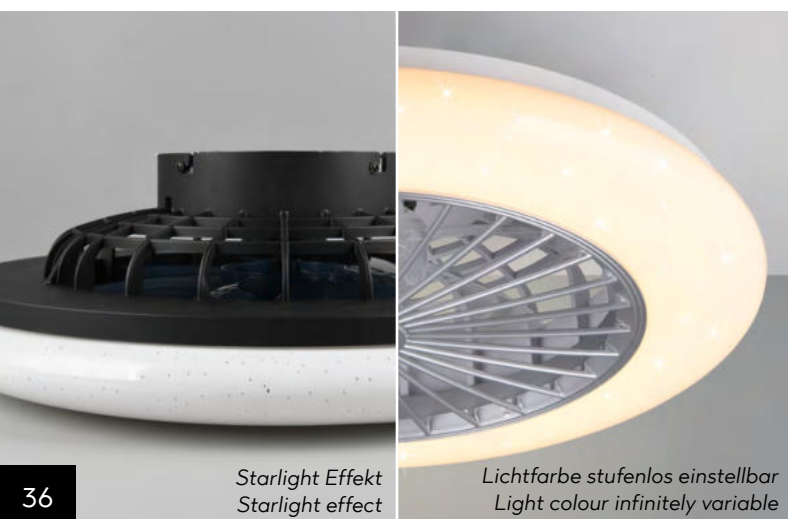

Starlight Effekt
Starlight effect

Lichtfarbe stufenlos einstellbar
Light colour infinitely variable



36



2.700 K 6.500 K

| Artikelnummer Art. No | R62522132 | R62522187 |
|------------------------------------|---|--|
| Material Material | Kunststoff Plastic | Kunststoff Plastic |
| Farbe Colour | Weiß matt White mat Schwarz matt Black mat | Weiß matt White mat Titanfarbig Titan |
| Leuchtmittel Lamps | incl. SMD-LED, 30 W | incl. SMD-LED, 30 W |
| Leuchtenlichtstrom Luminous flux | 3.500 lm | 3.500 lm |
| Lichtfarbe Light colour | 2.700 - 6.500 K | 2.700 - 6.500 K |

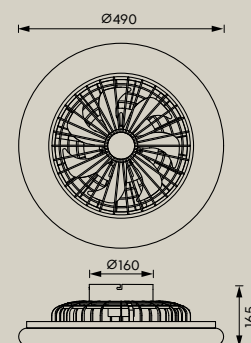

FARSUND



| Level | 1 | 2 | 3 |
|--|-----|-----|-----|
| Motor power consumption (W) | 6 | 10 | 15 |
| Airflow (m ³ /min) | 25 | 29 | 33 |
| RPM Rotations per minute | 620 | 825 | 955 |
| Service relationship (m ³ /min)/W | 4,1 | 2,9 | 2,2 |
| Sound level (db/A) | 40 | 45 | 53 |
| Maximum air speed (m/s) | | | 3,5 |
| Stand power | 0,5 | | |
| Room size (m ²) | <13 | | |

**DC
MOTOR**

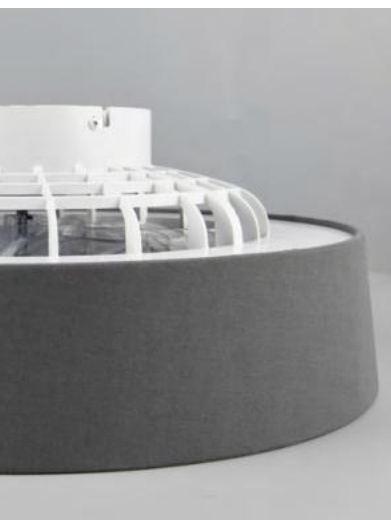

37



2.700 K 6.500 K

| | |
|------------------------------------|--|
| Artikelnummer Art. No | R62662111 |
| Material Material | Stoff Fabric Kunststoff Plastic |
| Farbe Colour | Grau Grey Weiß White |
| Leuchtmittel Lamps | incl. SMD-LED, 30 W |
| Leuchtenlichtstrom Luminous flux | 3.500 lm |
| Lichtfarbe Light colour | 2.700 - 6.500 K |

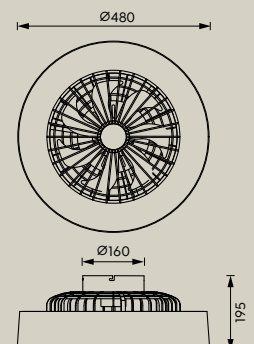

ROTSUND



| Level | 1 | 2 | 3 | 4 | 5 |
|--|------|------|------|------|------|
| Motor power consumption (W) | 5 | 7,5 | 9,9 | 12,5 | 15 |
| Airflow (m ³ /min) | 13,5 | 16 | 19 | 22 | 26 |
| RPM Rotations per minute | 940 | 1090 | 1190 | 1300 | 1380 |
| Service relationship (m ³ /min)/W | 2,7 | 2,1 | 1,9 | 1,8 | 1,7 |
| Sound level (db/A) | 48 | 52 | 55 | 57 | 58 |
| Maximum air speed (m/s) | 3,3 | 3,7 | 4 | 4,5 | 4,8 |
| Stand power | 0,36 | | | | |
| Room size (m ²) | <13 | | | | |

**DC
MOTOR**



Lichtfarbe stufenlos einstellbar
Light colour infinitely variable

38



2.700 K 6.500 K

| | |
|------------------------------------|--------------------------|
| Artikelnummer Art. No | R69222132 |
| Material Material | Kunststoff Plastic |
| Farbe Colour | Schwarz matt Black mat |
| Leuchtmittel Lamps | incl. SMD-LED, 22 W |
| Leuchtenlichtstrom Luminous flux | 3.000 lm |
| Lichtfarbe Light colour | 2.700 - 6.500 K |

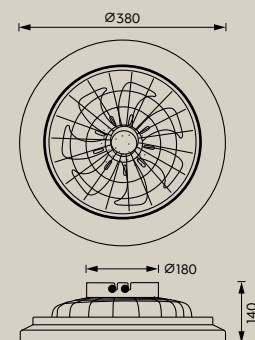

MORA



| Level | 1 | 2 | 3 |
|--|-----|-----|-----|
| Motor power consumption (W) | 6 | 9 | 12 |
| Airflow (m ³ /min) | 15 | 20 | 25 |
| RPM Rotations per minute | 520 | 680 | 850 |
| Service relationship (m ³ /min)/W | 2,5 | 2,2 | 2,1 |
| Sound level (db/A) | 35 | 43 | 52 |
| Maximum air speed (m/s) | | | 3,2 |
| Stand power | 0,5 | | |
| Room size (m ²) | <13 | | |

**DC
MOTOR**



Lichtfarbe stufenlos einstellbar
Light colour infinitely variable



39



2.700 K 6.000 K

| | |
|------------------------------------|----------------------|
| Artikelnummer Art. No | R64032101 |
| Material Material | Kunststoff Plastic |
| Farbe Colour | Weiß White |
| Leuchtmittel Lamps | incl. SMD-LED, 13 W |
| Leuchtenlichtstrom Luminous flux | 1.800 lm |
| Lichtfarbe Light colour | 2.700 - 6.000 K |

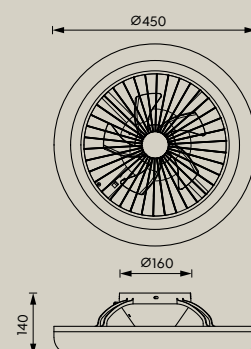

VARPULA



| Level | 1 | 2 | 3 | 4 | 5 | 6 |
|--|-----|-----|-----|------|------|------|
| Motor power consumption (W) | 1,5 | 4,5 | 8 | 11,3 | 14 | 15 |
| Airflow (m ³ /min) | 7 | 19 | 31 | 41 | 46 | 48 |
| RPM Rotations per minute | 160 | 600 | 800 | 950 | 1050 | 1100 |
| Service relationship (m ³ /min)/W | 4,7 | 4,2 | 3,9 | 3,6 | 3,3 | 3,2 |
| Sound level (db/A) | 32 | 34 | 38 | 43 | 49 | 55 |
| Maximum air speed (m/s) | 0,6 | 1,3 | 1,6 | 1,9 | 2,2 | 2,5 |
| Stand power | 0,5 | | | | | |
| Room size (m ²) | <13 | | | | | |

**DC
MOTOR**

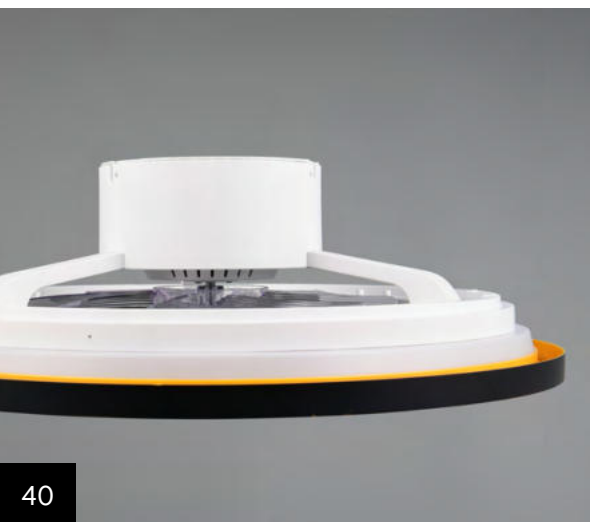
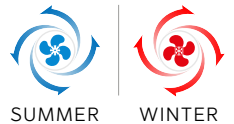

40



2.700 K 6.500 K

| | |
|------------------------------------|---|
| Artikelnummer Art. No | R69272180 |
| Material Material | Kunststoff Plastic |
| Farbe Colour | Schwarz-Gold Black Gold Weiß White |
| Leuchtmittel Lamps | incl. 1x SMD-LED, 28 W |
| Leuchtenlichtstrom Luminous flux | 3.200 lm |
| Lichtfarbe Light colour | 2.700 - 6.500 K |

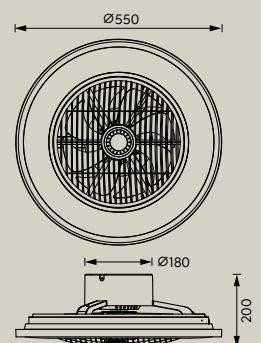



HARSTAD



| Level | 1 | 2 | 3 |
|--|-----|-----|-----|
| Motor power consumption (W) | 6 | 10 | 15 |
| Airflow (m ³ /min) | 25 | 29 | 33 |
| RPM Rotations per minute | 620 | 825 | 955 |
| Service relationship (m ³ /min)/W | 4,1 | 2,9 | 2,2 |
| Sound level (db/A) | 40 | 45 | 53 |
| Maximum air speed (m/s) | | | 3,5 |
| Stand power | 0,5 | | |
| Room size (m ²) | <13 | | |

**DC
MOTOR**

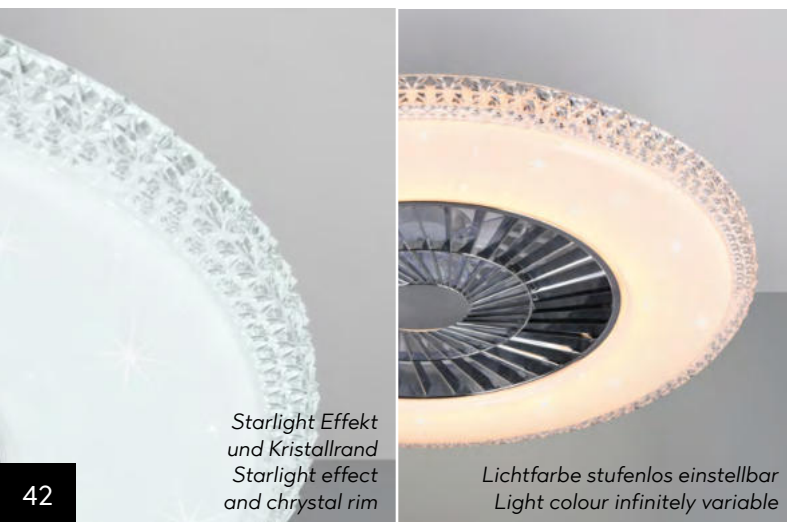
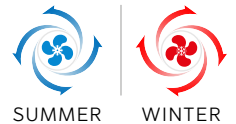

Starlight Effekt
und Kristallrand
Starlight effect
and chrysal rim

Lichtfarbe stufenlos einstellbar
Light colour infinitely variable



2.700 K 6.500 K

| | |
|------------------------------------|--|
| Artikelnummer Art. No | R62412106 |
| Material Material | Kunststoff Plastic Kristall Crystal |
| Farbe Colour | Weiß White Transparent Transparent |
| Leuchtmittel Lamps | incl. 1x SMD-LED, 38 W |
| Leuchtenlichtstrom Luminous flux | 4.400 lm |
| Lichtfarbe Light colour | 2.700 - 6.500 K |

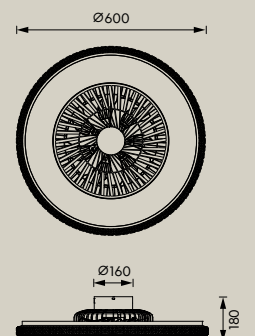

MUONIO



| Level | 1 | 2 | 3 |
|--|------|------|------|
| Motor power consumption (W) | 5 | 10 | 15 |
| Airflow (m ³ /min) | 22 | 31 | 38 |
| RPM Rotations per minute | 800 | 1000 | 1200 |
| Service relationship (m ³ /min)/W | 4,4 | 3,1 | 2,5 |
| Sound level (db/A) | 40 | 45 | 49 |
| Maximum air speed (m/s) | | | 6,3 |
| Stand power | 0,48 | | |
| Room size (m ²) | <13 | | |

**DC
MOTOR**



43



2.700 K 6.500 K

| | |
|------------------------------------|--------------------------|
| Artikelnummer Art. No | R69182132 |
| Material Material | Metall Metal |
| Farbe Colour | Schwarz matt Black mat |
| Leuchtmittel Lamps | incl. SMD-LED, 20 W |
| Leuchtenlichtstrom Luminous flux | 2.300 lm |
| Lichtfarbe Light colour | 2.700 - 6.500 K |

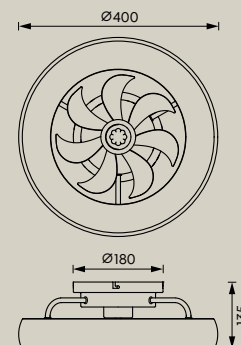

VISBY



| Level | 1 | 2 | 3 | 4 | 5 | 6 |
|--|-----|-----|-----|------|------|------|
| Motor power consumption (W) | 3 | 5 | 8 | 10,5 | 13 | 15 |
| Airflow (m ³ /min) | 15 | 23 | 29 | 33 | 36 | 39 |
| RPM Rotations per minute | 350 | 610 | 810 | 900 | 970 | 1050 |
| Service relationship (m ³ /min)/W | 5 | 4,6 | 3,6 | 3,1 | 2,8 | 2,6 |
| Sound level (db/A) | 31 | 35 | 42 | 48,5 | 52,5 | 55 |
| Maximum air speed (m/s) | | | | | | 3,5 |
| Stand power | 0,5 | | | | | |
| Room size (m ²) | <13 | | | | | |

DC MOTOR

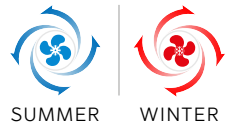

Lichtfarbe stufenlos einstellbar
Light colour infinitely variable
Starlight Effekt / Starlight effect



44



2.700 K 6.500 K

| | |
|------------------------------------|----------------------|
| Artikelnummer Art. No | R62402106 |
| Material Material | Kunststoff Plastic |
| | Chrom Chrome |
| Farbe Colour | Weiß White |
| | Chrom Chrome |
| Leuchtmittel Lamps | incl. SMD-LED, 38 W |
| Leuchtenlichtstrom Luminous flux | 4.400 lm |
| Lichtfarbe Light colour | 2.700 - 6.500 K |

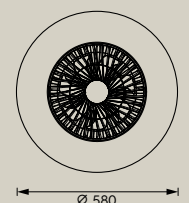
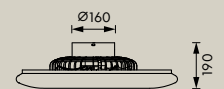

HALMSTAD



| Level | 1 | 2 | 3 |
|--|-----|-----|-----|
| Motor power consumption (W) | 6 | 10 | 15 |
| Airflow (m ³ /min) | 25 | 29 | 33 |
| RPM Rotations per minute | 620 | 825 | 955 |
| Service relationship (m ³ /min)/W | 4,1 | 2,9 | 2,2 |
| Sound level (db/A) | 40 | 45 | 53 |
| Maximum air speed (m/s) | | | 3,5 |
| Stand power | 0,5 | | |
| Room size (m ²) | <13 | | |

**DC
MOTOR**

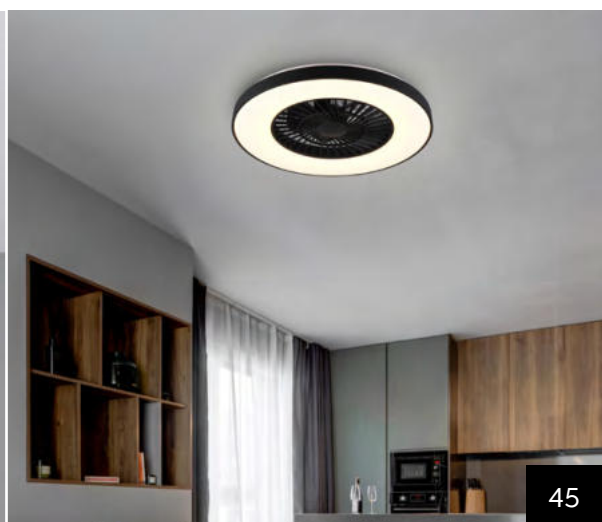

45



2.700 K 6.500 K

| | |
|------------------------------------|--|
| Artikelnummer Art. No | R62672132 |
| Material Material | Kunststoff Plastic |
| Farbe Colour | Schwarz matt Black mat Weiß White |
| Leuchtmittel Lamps | incl. 1x SMD-LED, 38 W |
| Leuchtenlichtstrom Luminous flux | 4.400 lm |
| Lichtfarbe Light colour | 2.700 - 6.500 K |

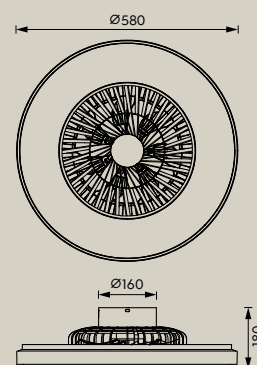

SAARELA



| Level | 1 | 2 | 3 | 4 | 5 | 6 |
|--|-----|-----|------|-----|------|-----|
| Motor power consumption (W) | 8,4 | 9,5 | 10,5 | 12 | 13,7 | 15 |
| Airflow (m ³ /min) | 20 | 24 | 28 | 35 | 42 | 48 |
| RPM Rotations per minute | 550 | 585 | 605 | 645 | 675 | 705 |
| Service relationship (m ³ /min)/W | 2,4 | 2,5 | 2,7 | 2,9 | 3,1 | 3,2 |
| Sound level (db/A) | 40 | 41 | 42 | 43 | 45 | 48 |
| Maximum air speed (m/s) | 2 | 2,5 | 3,1 | 3,4 | 3,7 | 4 |
| Stand power | 0,5 | | | | | |
| Room size (m ²) | <13 | | | | | |

**DC
MOTOR**

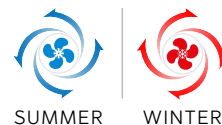

SUMMER

WINTER



Lichtfarbe einstellbar
Light colour variable



46



3.000 K 4.000 K 6.500 K

| | |
|------------------------------------|--------------------------|
| Artikelnummer Art. No | R69472101 |
| Material Material | Kunststoff Plastic |
| Farbe Colour | Schwarz matt Black mat |
| Leuchtmittel Lamps | incl. SMD-LED, 38 W |
| Leuchtenlichtstrom Luminous flux | 3.800 lm |
| Lichtfarbe Light colour | 3.000+4.000+6.500 K |

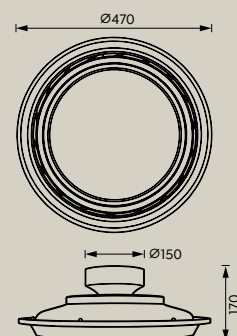

KURULA



| Level | 1 | 2 | 3 | 4 | 5 | 6 |
|--|------|-----|------|------|------|------|
| Motor power consumption (W) | 1,5 | 4 | 7 | 10,5 | 13 | 15 |
| Airflow (m ³ /min) | 10,5 | 24 | 33 | 37 | 41 | 43 |
| RPM Rotations per minute | 160 | 610 | 810 | 950 | 1050 | 1100 |
| Service relationship (m ³ /min)/W | 7 | 6 | 4,8 | 3,5 | 3,1 | 2,9 |
| Sound level (db/A) | 31 | 35 | 40,5 | 48,5 | 52,5 | 55 |
| Maximum air speed (m/s) | 0,9 | 1,5 | 2,1 | 2,5 | 2,9 | 3,2 |
| Stand power | 0,5 | | | | | |
| Room size (m ²) | <13 | | | | | |

**DC
MOTOR**

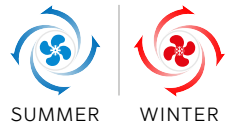

SUMMER WINTER



Oszillierend
Oscillating



Lichtfarbe stufenlos einstellbar
Light colour infinitely variable



Fernbedienung inkl. Halterung
Remote control including wall mount



2.700 K 6.500 K

| | |
|------------------------------------|----------------------|
| Artikelnummer Art. No | R69382101 |
| Material Material | Kunststoff Plastic |
| Farbe Colour | Weiß White |
| Leuchtmittel Lamps | incl. SMD-LED, 37 W |
| Leuchtenlichtstrom Luminous flux | 4.300 lm |
| Lichtfarbe Light colour | 2.700 - 6.500 K |

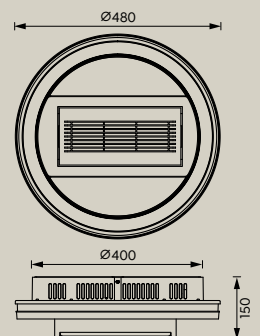

SMILLUM



| Level | 1 | 2 | 3 |
|--|-----|-----|-----|
| Motor power consumption (W) | 11 | 19 | 28 |
| Airflow (m ³ /min) | 36 | 48 | 57 |
| RPM Rotations per minute | 620 | 825 | 955 |
| Service relationship (m ³ /min)/W | 3,3 | 2,6 | 2,1 |
| Sound level (db/A) | 43 | 48 | 55 |
| Maximum air speed (m/s) | | | 5,2 |
| Stand power | 0,5 | | |
| Room size (m ²) | <13 | | |

**DC
MOTOR**

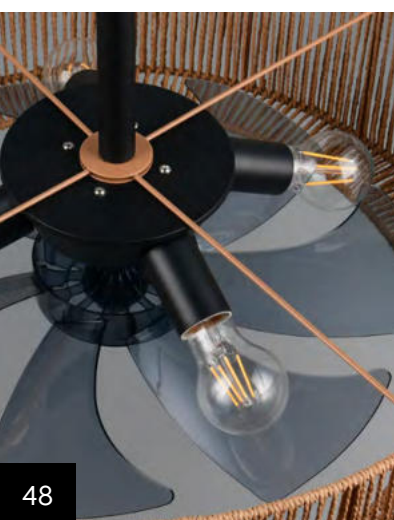
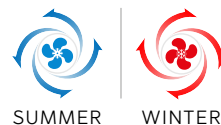

| | |
|--|--------------------------|
| Artikelnummer Art. No | R66905036 |
| Material Material | Metall Metal |
| | Hanf Hemp material |
| Farbe Colour | Schwarz matt Black mat |
| | Naturbelassen Natural |
| Leuchtmittel Lamps | excl. 4x E27*, max. 10 W |
| Leuchtenlichtstrom Luminous flux | 470 lm |
| Lichtfarbe Light colour | 2.700 K |
| Empfohlen/recommended: 987-400 , Filament LED E27, 4 W, 470 lm, 2.700 K | |

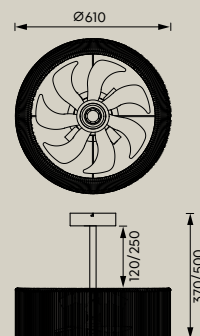



TRONDHEIM



| Level | 1 | 2 | 3 |
|--|-----|-----|-----|
| Motor power consumption (W) | 6 | 10 | 15 |
| Airflow (m ³ /min) | 26 | 34 | 39 |
| RPM Rotations per minute | 600 | 790 | 910 |
| Service relationship (m ³ /min)/W | 4,3 | 3,4 | 2,6 |
| Sound level (db/A) | 41 | 47 | 54 |
| Maximum air speed (m/s) | | | 4 |
| Stand power | 0,5 | | |
| Room size (m ²) | <13 | | |

**DC
MOTOR**



R61095032



50



| Artikelnummer Art. No | R61095032 | R61105032 |
|------------------------------------|--------------------------|--------------------------|
| Material Material | Metall Metal | Metall Metal |
| | Kunststoff Plastic | Kunststoff Plastic |
| Farbe Colour | Schwarz matt Black mat | Schwarz matt Black mat |
| | Schwarz Black | Holzfarbig Wood |
| Leuchtmittel Lamps | excl. 4x E27 max. 10 W* | excl. 4x E27 max. 10 W* |
| Leuchtenlichtstrom Luminous flux | 470 lm | 470 lm |
| Lichtfarbe Light colour | 2.700 K | 2.700 K |

*Empfohlen/recommended: 987-400, Filament LED E27, 4 W, 470 lm, 2.700 K

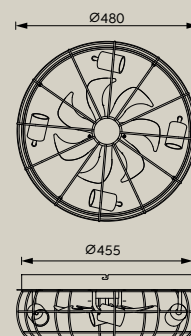

LILLESAND



| Level | 1 | 2 | 3 |
|--|-----|-----|-----|
| Motor power consumption (W) | 6 | 10 | 15 |
| Airflow (m ³ /min) | 26 | 34 | 39 |
| RPM Rotations per minute | 600 | 790 | 910 |
| Service relationship (m ³ /min)/W | 4,3 | 3,4 | 2,6 |
| Sound level (db/A) | 41 | 47 | 54 |
| Maximum air speed (m/s) | | | 4 |
| Stand power | 0,5 | | |
| Room size (m ²) | <13 | | |

**DC
MOTOR**



51



| | |
|---|--------------------------|
| Artikelnummer Art. No | R67302126 |
| Material Material | Metall Metal |
| | Papier Paper |
| Farbe Colour | Schwarz matt Black mat |
| | Braun Brown |
| Leuchtmittel Lamps | excl. 4x E27, max. 10 W* |
| Leuchtenlichtstrom Luminous flux | 470 lm |
| Lichtfarbe Light colour | 3.000 K |
| *Empfohlen/recommended: 987-479 , Filament LED E27, 4 W, 470 lm, 3.000 K | |

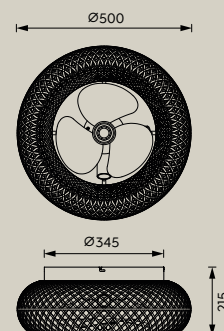

BIDAR



| Level | 1 | 2 | 3 |
|--|-----|-----|-----|
| Motor power consumption (W) | 6 | 10 | 15 |
| Airflow (m ³ /min) | 26 | 34 | 39 |
| RPM Rotations per minute | 600 | 790 | 910 |
| Service relationship (m ³ /min)/W | 4,3 | 3,4 | 2,6 |
| Sound level (db/A) | 41 | 47 | 54 |
| Maximum air speed (m/s) | | | 3,9 |
| Stand power | 0,5 | | |
| Room size (m ²) | <13 | | |

**DC
MOTOR**

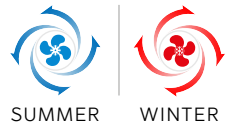

52



| Artikelnummer Art. No | R61574031 | R61574080 |
|------------------------------------|--------------------------|---|
| Material Material | Metall Metal | Metall Metal |
| Farbe Colour | Weiß matt White mat | Schwarz matt Black mat Gold Gold |
| Leuchtmittel Lamps | excl. 3x E27*, max. 10 W | excl. 3x E27*, max. 10 W |
| Leuchtenlichtstrom Luminous flux | 470 lm | 470 lm |
| Lichtfarbe Light colour | 2.700 K | 2.700 K |

Empfohlen/recommended: 987-400, Filament LED E27, 4 W, 470 lm, 2.700 K

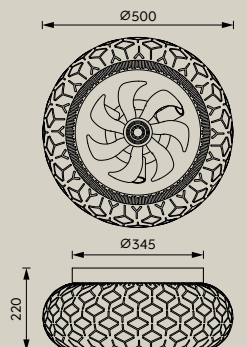

JOHANNA



| Level | 1 | 2 | 3 |
|--|-----|-----|-----|
| Motor power consumption (W) | 11 | 19 | 28 |
| Airflow (m ³ /min) | 35 | 47 | 55 |
| RPM Rotations per minute | 620 | 825 | 955 |
| Service relationship (m ³ /min)/W | 3,2 | 2,5 | 2 |
| Sound level (db/A) | 43 | 48 | 55 |
| Maximum air speed (m/s) | | | 5,2 |
| Stand power | 0,5 | | |
| Room size (m ²) | <13 | | |

**DC
MOTOR**



53



| | |
|--|--------------------------|
| Artikelnummer Art. No | R66884032 |
| Material Material | Metall Metal |
| Farbe Colour | Schwarz matt Black mat |
| Leuchtmittel Lamps | excl. 3x E27*, max. 10 W |
| Leuchtenlichtstrom Luminous flux | 470 lm |
| Lichtfarbe Light colour | 2.700 K |
| Empfohlen/recommended: 987-400 , Filament LED E27, 4 W, 470 lm, 2.700 K | |

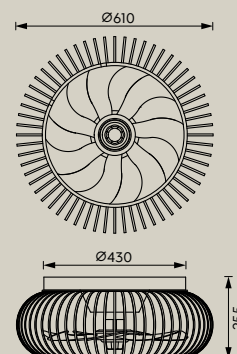

OSLO



| Level | 1 | 2 | 3 | 4 | 5 | 6 |
|--|-----|------|-----|-----|-----|------|
| Motor power consumption (W) | 1,2 | 3,23 | 6,5 | 10 | 15 | 20 |
| Airflow (m ³ /min) | 11 | 27 | 43 | 49 | 55 | 62 |
| RPM Rotations per minute | 160 | 500 | 670 | 800 | 900 | 1000 |
| Service relationship (m ³ /min)/W | 9,2 | 8,3 | 6,6 | 4,9 | 3,7 | 3,1 |
| Sound level (db/A) | 31 | 39 | 46 | 53 | 57 | 59 |
| Maximum air speed (m/s) | 0,5 | 1,6 | 2,1 | 2,5 | 2,9 | 3,2 |
| Stand power | 0,5 | | | | | |
| Room size (m ²) | <13 | | | | | |

DC MOTOR



IP44

Schutzklasse IP44
Protection class IP44



Lichtfarbe stufenlos einstellbar
Light colour infinitely variable



Kabel inkl. Stecker | 3000 mm
Cable incl. plug | 3000 mm

54



2.700 K 6.000 K

| Artikelnummer Art. No | R69692101 | R69692102 |
|------------------------------------|----------------------|----------------------|
| Material Material | Kunststoff Plastic | Kunststoff Plastic |
| Farbe Colour | Weiß White | Schwarz Black |
| Leuchtmittel Lamps | incl. SMD-LED, 20 W | incl. SMD-LED, 20 W |
| Leuchtenlichtstrom Luminous flux | 2.300 lm | 2.300 lm |
| Lichtfarbe Light colour | 2.700 - 6.000 K | 2.700 - 6.000 K |

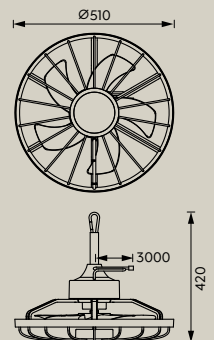



RENA



5h 4,5-10h

| Level | 1 | 2 | 3 | 4 |
|--|------|------|------|-----|
| Motor power consumption (W) | 1,05 | 1,44 | 1,8 | 2,5 |
| Airflow (m ³ /min) | 6,52 | 8,44 | 9,98 | 11 |
| RPM Rotations per minute | 750 | 820 | 880 | 970 |
| Service relationship (m ³ /min)/W | 6,21 | 5,86 | 5,54 | 4,4 |
| Sound level (db/A) | 25 | 28 | 30,3 | 34 |
| Maximum air speed (m/s) | 0,77 | 1 | 1,18 | 1,2 |
| Stand power | | | | |
| Room size (m ²) | | | | |



Akkubetrieb / 5 Geschwindigkeitsstufen /
Aufhängung mittels Deckenhaken
Rechargeable battery operated / 5 modes
of speed / Suspension using ceiling hooks



| | |
|------------------------------------|--|
| Artikelnummer Art. No | R050-01 |
| Material Material | Kunststoff Plastic |
| Farbe Colour | Weiß White Holzfarbig Wood coloured |
| Leuchtmittel Lamps | incl. SMD-LED, 0,5 W |
| Leuchtenlichtstrom Luminous flux | 60 lm |
| Lichtfarbe Light colour | 4.000 K |

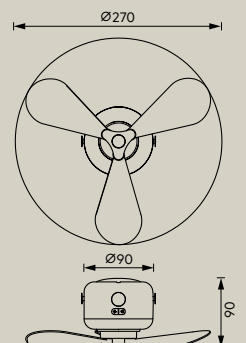

BREEZY



| Artikelnummer Art. No | R044-01 | R044-02 | R044-49 |
|-------------------------------|-------------------------|-------------------------|---------------------------------|
| Material Material | Kunststoff Plastic | Kunststoff Plastic | Kunststoff Plastic |
| Farbe Colour | Weiß White | Schwarz Black | Pistaziengrün Pistachio green |
| Leistung Motor Power Engine | 2 W | 2 W | 2 W |
| Volumenstrom Volume flow | 1,8 m ³ /min | 1,8 m ³ /min | 1,8 m ³ /min |

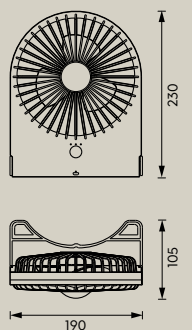

VIKING



58



| | |
|--------------------------------------|---|
| Artikelnummer Art. No | R034-32 |
| Material Material | Metall Metal |
| Farbe Colour | Schwarz matt Black mat Holzfarbig Wood |
| Leistung Motor Power Engine | 50 W |
| Volumenstrom Volume flow | 64,91 m ³ /min |

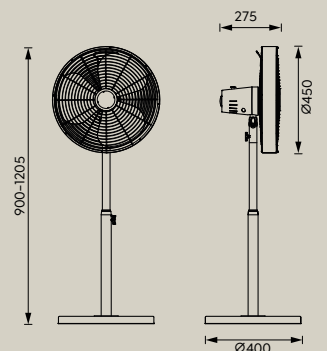

































INDEX

| Art-Nr. Art.-No. | EAN | Familie Family | DC | Seite Page | Art-Nr. Art.-No. | EAN | Familie Family | DC | Seite Page |
|---------------------|---------------|-------------------|------|---------------|---------------------|---------------|-------------------|----|---------------|
| R034-32 | 4017807456806 | VIKING | | 58 | R69622101 | 4017807689310 | KIRUNA | ✓ | 18 |
| R044-01 | 4017807564464 | BREEZY | | 57 | R69642101 | 4017807689068 | VOLDA | ✓ | 14 |
| R044-02 | 4017807564471 | BREEZY | | 57 | R69642107 | 4017807689075 | VOLDA | ✓ | 14 |
| R044-49 | 4017807564495 | BREEZY | | 57 | R69652101 | 4017807689099 | VANSBRO | ✓ | 19 |
| R050-01 | 4017807689228 | RENA | | 56 | R69682130 | 4017807689297 | FLEN | ✓ | 13 |
| R61095032 | 4017807529562 | TRONDHEIM | ✓ | 50 | R69692102 | 4017807689136 | OSLO | ✓ | 54 |
| R61105032 | 4017807529586 | TRONDHEIM | ✓ | 50 | | | | | |
| R61574031 | 4017807643978 | BIDAR | ✓ | 52 | | | | | |
| R61574080 | 4017807643985 | BIDAR | ✓ | 52 | | | | | |
| R62402106 | 4017807457766 | VISBY | ✓ | 44 | | | | | |
| R62412106 | 4017807461206 | HARSTAD | ✓ | 42 | | | | | |
| R62522132 | 4017807491098 | STRALSUND | ✓ | 36 | | | | | |
| R62522187 | 4017807466157 | STRALSUND | ✓ | 36 | | | | | |
| R62522987 | 4017807491128 | STRALSUND | ✓ | 33 | | | | | |
| R62662111 | 4017807491081 | FARSUND | ✓ | 37 | | | | | |
| R62672132 | 4017807491036 | HALMSTAD | ✓ | 45 | | | | | |
| R62732131 | 4017807643947 | HELSINKI | ✓ | 10 | | | | | |
| R62732132 | 4017807643954 | HELSINKI | ✓ | 10 | | | | | |
| R64032101 | 4017807650419 | MORA | ✓ | 39 | | | | | |
| R64202131 | 4017807643602 | GÖTEBORG | ✓ | 6 | | | | | |
| R64202132 | 4017807643640 | GÖTEBORG | ✓ | 6 | | | | | |
| R64262131 | 4017807644364 | STOCKHOLM | ✓ | 27 | | | | | |
| R64262132 | 4017807644371 | STOCKHOLM | ✓ | 27 | | | | | |
| R64262932 | 4017807693133 | STOCKHOLM | ✓ | 28 | | | | | |
| R64412131 | 4017807643770 | RANDERS | ✓ | 9 | | | | | |
| R64412132 | 4017807643787 | RANDERS | ✓ | 9 | | | | | |
| R64452131 | 4017807644487 | KASFJORD | ✓ | 16 | | | | | |
| R64452132 | 4017807693201 | KASFJORD | ✓ | 16 | | | | | |
| R64462102 | 4017807644517 | LINKÖPING | ✓ | 31 | | | | | |
| R66592031 | 4017807681734 | HAMMERFEST | ✓/AC | 12 | | | | | |
| R66884032 | 4017807688115 | JOHANNA | ✓ | 53 | | | | | |
| R66905036 | 4017807688139 | SMILLUM | ✓ | 48 | | | | | |
| R67302126 | 4017807605259 | LILLESAND | ✓ | 51 | | | | | |
| R67393132 | 4017807606027 | SORTLAND | ✓ | 26 | | | | | |
| R67462131 | 4017807643695 | LUND | ✓ | 8 | | | | | |
| R67462132 | 4017807643732 | LUND | ✓ | 8 | | | | | |
| R69172131 | 4017807688207 | PAJALA | ✓ | 25 | | | | | |
| R69182132 | 4017807688221 | MUONIO | ✓ | 43 | | | | | |
| R69192134 | 4017807688245 | SKAULO | ✓ | 34 | | | | | |
| R69222132 | 4017807693164 | ROTSUND | ✓ | 38 | | | | | |
| R69272180 | 4017807688597 | VARPULA | ✓ | 40 | | | | | |
| R69282101 | 4017807688665 | HOLMSUND | ✓ | 32 | | | | | |
| R69302102 | 4017807688795 | SVAERHOLT | ✓ | 30 | | | | | |
| R69382101 | 4017807688825 | KURULA | ✓ | 47 | | | | | |
| R69472101 | 4017807688917 | SAARELA | ✓ | 46 | | | | | |
| R69512101 | 4017807688924 | MOSS | ✓ | 24 | | | | | |
| R69532101 | 4017807688948 | TAMPERE | ✓ | 22 | | | | | |
| R69542131 | 4017807690514 | BORAS | ✓ | 23 | | | | | |
| R69572101 | 4017807688986 | KERAVA | ✓ | 20 | | | | | |

PRODUKTEIGENSCHAFTEN | FEATURES

-  Getrennt schaltbar | Separately switchable
-  Schalter | Switch
-  Fernbedienung | Remote control
-  Integrierter Dimmer | Integrated dimmer
-  Lichtfarbe stufenlos einstellbar | Light colour infinitely variable
-  Nachtlicht | Night Light
-  Starlight Effekt | Starlight effect
-  Ventilator | Fan
-  3 Geschwindigkeitsstufen | 3 modes of speed
-  5 Geschwindigkeitsstufen | 5 modes of speed
-  6 Geschwindigkeitsstufen | 6 modes of speed
-  Timer | Timer
-  Sommer- und Winterbetrieb | Summer and winter operation
-  Memory Funktion | Memory function
-  RGBW Farbwechsler | RGBW Colourchanging
-  Oszillierend | Oscillating
-  Kippbar | Tilttable
-  Höhenverstellbar | Adjustable height
-  Ohne Leuchtmittel | Lamp(s) not included
-  Bluetooth Lautsprecher | Bluetooth loudspeaker
-  In der Höhe anpassbar | Adjustable in height
-  LED Switch Dimmer | LED Switch Dimmer
-  USB Anschluss | USB connection
-  Sleep timer | Sleep timer
-  Akkubetrieb | Rechargeable battery operated
-  Das Gerät verfügt über eine Heizleistungsstufe
The unit has one heating power level
-  USB-C Anschluss | USB-C connection
-  4000 K | 4000 K
-  Dynamische Lichtsteuerung | Dynamic light control
-  Lichtfarbe einstellbar | Adjustable light colour
-  IP44
-  Zugschalter | Pull switch

REALITY Leuchten GmbH

Gut Nierhof 17
D-59757 Arnsberg
T +49 2931 9666-99
F +49 2931 9666-98
info@reality-leuchten.com
www.reality-leuchten.com

DEUTSCHLAND

BADEN WÜRTTEMBERG,
RHEINLAND-PFALZ UND SAARLAND

Antonio De Simone
T +49 (0) 151 5855222
antonio.desimone@trio-leuchten.de

BAYERN, HESSEN

Martin Kluge
T +49 (0) 171 7300330
martin.kluge@trio-leuchten.de

BERLIN, BRANDENBURG
MECKLENBURG-VORPOMMERN,
SACHSEN, SACHSEN-ANHALT,
THÜRINGEN

Jörg Bumke
T +49 (0) 160 7406860
joerg.bumke@trio-leuchten.de

BREMEN, HAMBURG, NIEDERSACHSEN,
SCHLESWIG-HOLSTEIN

Jens Gebers
T +49 (0) 170 1615227
jens.gebers@trio-leuchten.de

HESSEN, NORDRHEIN-WESTFALEN,
RHEINLAND-PFALZ

Christian Teller
T +49 (0) 171 4521820
christian.teller@trio-leuchten.de

ÖSTERREICH

Wolfgang Melich
T +43 (0) 660 5161228
wolfgang.melich@trio-leuchten.de

SCHWEIZ

TRIO Leuchten GmbH
T +49(0)2931 9666 99
info@trio-leuchten.de



TRIO International GmbH

Gut Nierhof 17
D-59757 Arnsberg
T +49 2931 9666-587
F +49 2931 9666-56

info@trio-lighting.com
www.trio-lighting.com

FRANCE

Stéphane Papierny

Directeur commercial France
T +33 9 74 77 07 90
info.france@trio-lighting.com

Jean Barel

Agent commercial pour les départements
09, 12, 15, 16, 19, 24, 31, 32, 33, 40, 46,
47, 64, 65, 81, 82 et 87

Daho Bekhti

Agent commercial pour les départements
02, 59, 60, 62 et 80

Jean Marc Beneforti

Agent commercial pour les départements
2a et 2b

Maïté Jourdan Casu

Chef des Ventes et Responsable
Comptes clés | France

Stéphane Kerjean

Agent commercial pour les départements
14, 17, 22, 29, 35, 36, 37, 41, 44, 49, 50,
53, 56, 61, 72, 79, 85 et 86

Sylvain Martin

Agent commercial pour les territoires
des DROM-COM

Christophe Meulien

Agent commercial pour les départements
04, 05, 06, 11, 13, 30, 34, 66, 83, 84 et 98

Agence Nao West | Aymeric Monnet et Marie Lafleuril

Agent commercial GSB pour les
départements 14, 22, 29, 35, 37, 41, 44,
49, 50, 53, 56, 61, 72, 79, 85 et 86

Sullivan Nicolas

Commercial pour les départements
01, 03, 07, 21, 23, 26, 38, 39, 42, 43, 48,
63, 69, 71, 73 et 74

Stéphane Riebel

Agent commercial pour les départements
18, 27, 28, 45, 58, 75, 76, 77, 78, 89, 91,
92, 93, 94 et 95

Agence Rouquié | Bruno Rouquié

Agent commercial GSB pour les départe-
ments 09, 12, 15, 16, 17, 18, 19, 24, 31,
32, 33, 36, 40, 46, 47, 64, 65, 81, 82 et 87

Vincent Zaepffel

Commercial pour les départements
08, 10, 25, 51, 52, 54, 55, 57, 67, 68, 70,
88 et 90

BELGIUM / LUXEMBURG

**Yves Van den Berghe / Frank Boesmans /
Pauline Delorme / Wim Deplae**
info.belgium@trio-lighting.com

DENMARK

Jan Rantzau-Bartens
info.denmark@trio-lighting.com

NETHERLANDS

Karl Stok / Bas Martin
info.nederland@trio-lighting.com

ROMANIA

Loredana Barbu
T (+40) 741 788 674
info.romania@trio-lighting.com

GREAT BRITAIN

TRIO Lighting UK Ltd.
Unit 5, Hemmells Park Hemmells,
Laindon Essex
SS1s 6GF
T +44 (0) 12 68 88 95 95
F +44 (0) 12 68 88 95 96
sales@triolightinguk.com

ITALY

TRIO Lighting Italia s.r.l.
Via Isonzo, 81
22066 Mariano Comense (CO)
T +39 (0) 317 477 55
F +39 (0) 313 551 560
commerciale@trio-lighting.com

NORDIC AND BALTIC

TRIO Lighting Scandinavia Oy
Malmin raitti, rappu 17 B
00700 Helsinki
T +358 (0) 10 23 13 390
TLS@trio-lighting.com
Our Scandinavian organisation represents TRIO also in
Finland, Sweden, Norway, Iceland, Estonia, Latvia and
Lithuania

SPAIN

TRIO Lighting Ibèrica S.L.
C/VALLESPIR 19, Plta 2, módulo 1.1
08173 Sant Cugat del Vallès
T +34 (0) 935 458 630
info.iberica@trio-lighting.com

AFRICA

F&M Global
T (+32) 4719 22111
hans.deserranno@fmglobal.be
Ina Concept
T (+32) 4719 94693
jerome.freri@ina-concept.com

ALBANIA

Kika Light
T (+355) 672 084 781
kika1light@gmail.com

BOSNIA AND HERZEGOVINA

GRIČ d.o.o.
T (+38) 7039 706 658
daniel.martinovic@tel.net.ba

BULGARIA

ATG Bulgaria
T (+359) 899 927 707
deyana_petrova@atg-apa.net

CZECH REPUBLIC

Luminex spol. s.r.o.
T (+42) 777 570 560
objednavky@luminex.cz

GREECE / CYPRUS

Solomon Lighting S.A.
T (+30) 21060 46003
alberto@solomongroup.gr

HUNGARY

Luxera Kft.
T (+36) 83 3163 88
info@trio-lampa.hu

KOSOVO

ACN
T (+383) 44 344 434
info@acn-ks.com

NORTH MACEDONIA

Elektro Megavat
T (+389) 71665006
contact@megalight.com.mk

POLAND

Delighting Polska sp. z.o.o.
T (+48) 61 4367 481
kontakt@delighting.pl

REPUBLIC OF MOLDOVA

Volta LTD
T (+37) 322 26 7775
import5@volta.md

SERBIA

Aura Light d.o.o. Novi Sad
T (+38) 121 2100724
aura.lightdoo@gmail.com

SLOVAKIA

Feim SK s.r.o.
T (+42) 134 7743 228
svietidla@feim.sk

SLOVENIA

BT Trade d.o.o.
T (+386) 41 676 006
info@butiksvetil.si

TURKIYE

Soho Aydinlatma Ticaret Ltd.
T (+90) 2165 7669 41
kartal.kendirci@soholight.com

UKRAINE

MAX Light
T (+38) 4446 37942
tanya@maxlight.ua



Reality Leuchten GmbH

Gut Nierhof 17
D-59757 Arnsberg
T +49 2931 9666-99
F +49 2931 9666-98

info@reality-leuchten.de
www.reality-leuchten.de

TRIO International GmbH

Gut Nierhof 17
D-59757 Arnsberg
T +49 2931 9666-587
F +49 2931 9666-56

info@trio-lighting.com
www.trio-lighting.com