

TRIO  
LIGHTING FOR YOU



OUTDOOR  
AUSSENLEUCHTEN | 2026  
OUTDOOR LUMINAIRES

Mehr Komfort, mehr Sicherheit – die neuen Funktionen unserer Außenleuchten.  
More convenience, more safety - the new functions of our outdoor lights.



### MOTION SENSOR MULTICONTROL

Der integrierte Bewegungssensor der Hauptleuchte kann eine bestimmte Anzahl weiterer Leuchten mitsteuern. Die zusätzlichen Leuchten empfangen das Signal der Hauptleuchte und benötigen daher keinen eigenen Sensor.

The integrated motion sensor of the main light can also control a certain number of additional lights. The additional lights receive the signal from the main light and therefore do not require their own sensor.

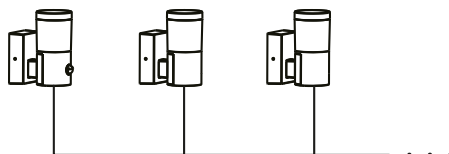

max. 8 pcs.

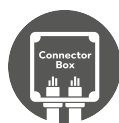

### CONNECTOR BOX

Der Anschlusskasten dieser Leuchten ist so ausgelegt, dass er zwei Anschlussleitungen aufnehmen kann. Dadurch lassen sich mehrere Leuchten problemlos in Reihe schalten.

The connection box of these lights is designed to accommodate two connection cables. This means that several lights can be easily connected in series.



max. 8 pcs.



## Robuste Außenleuchten für Küstenregionen · Robust outdoor lights for coastal regions

Leuchten, mit dem Label „Seaside Ready“, sind die perfekte Wahl für alle, die in maritimen Umgebungen leben. Dank hochwertiger Materialien und spezieller Oberflächenbeschichtungen trotzen sie selbst den härtesten Bedingungen an der Küste. Salzhaltige Luft und wechselnde Witterung können diesen Leuchten nichts anhaben.

Luminaires with the "Seaside Ready" label are the perfect choice for anyone who lives in a maritime environment. Thanks to high-quality materials and special surface coatings, they can withstand even the harshest conditions on the coast. Salty air and changing weather conditions are no match for these lights.



**10 Jahre Garantie** auf Korrosionsschutz bei Leuchten aus pulverbeschichtetem Aluminium. Ausgenommen sind Ausbleichen der Oberfläche sowie technische Komponenten.

**10-year guarantee** on corrosion protection for luminaires made of powder-coated aluminum. This excludes fading of the surface and technical components.



**15 Jahre Garantie** auf Korrosionsschutz bei Leuchten aus feuerverzinktem Edelstahl. Ausgenommen sind Ausbleichen der Oberfläche sowie technische Komponenten.

**15-year guarantee** on corrosion protection for luminaires made of hot-dip galvanized stainless steel. This excludes fading of the surface and technical components.

## Inhaltsverzeichnis · General Index

Index général · Algemene index · Índice general ·

Indice generale · Index general · Yleisindeksi · Ogólny indeks



12

### TRIO AUSSENLEUCHTEN

TRIO OUTDOOR LUMINAIRES

120

### REALITY AUSSENLEUCHTEN

REALITY OUTDOOR LUMINAIRES

144

### LED-SOLARLEUCHTEN

LED-SOLAR LIGHTS

178

### OUTDOOR LIVING

OUTDOOR LIVING



## Serienübersicht · Family overview

Aperçu par famille · Overzicht per familie · Vista general por familia ·

Panoramica per famiglia · Prezentare pe familia de produse · Perheen yleiskuvaus · Przegląd rodziny



ADAJA	40	MAYENNE	43	ACORA	169	MORO	156
ADOUR	38	MERSEY	44	ALMERIA	139	MOURA	166
ARDAS	53	MIRANDE	115	ALVORADA	158	OBIDOS	174
ARDILA	66	MURES	76	AMBATO	131	OLINDA	162
ATRATO	103	NESTOS	12	ARUBA	188	PALMAS	186
AVON	36	NORMAN	102	ATICO	159	POSADAS	164
BARITO	100	OHIO	42	BARCELOS	131	PUELO	134
BELAJA	116	OLONA	112	BEJA	122	PUNO	129
BENI	55	PARANA	51	BILBAO	155	PURUS	143
BERMEJO	46	PEARL	30	BOLO	142	RAMOS	158
BLYDE	146	PEARL	31	BONITO	138	RICARDO	185
BREG	49	PIAVE	47	BRAGA	124	ROSARIO	127
BRENTA	102	RAVI	14	CACERES	143	SALTA	167
CAVADO	88	RENO	32	CAMARO	136	SCOOP	140
COLORADO	52	ROYA	56	CAMPUS	176	SILVES	154
COOPER	70	RUVUMA	98	CHAIN	191	SINTRA	135
CUANDO	42	SALMON	18	COBRE	157	STICK	140
DAWSON	29	SAMBESI	90	COLOMBO	150	SUAREZ	180
DUERO	114	TAGUS	20	CORDOBA	126	TALCA	171
ELBE	61	TANA	101	CUSCO	125	VIAMAO	162
ELVO	106	TANARO	113	DIADEMA	168		
FRASER	72	TAWA	39	DIAZ	184		
FUERTE	24	TAY	52	ELVAS	170		
GARONNE	95	THAMES	40	EMBER	190		
HOOSIC	78	THAMES II	41	ESQUEL	164		
HORTON	34	TIBER	53	FERNANDEZ	182		
HUDSON	86	TIMOK	48	FESTIVAL	175		
INDUS	48	TRENT	43	FOMOSA	167		
KANSAS	35	TRIOTO	64	FORTALEZA	130		
KASAI	44	TUMEN	100	FUNCHAL	132		
KAVERI	54	TURIA	50	GORDA	152		
KONDA	45	UBANGI	117	JAMAICA	189		
LIVENZA	108	VENTA	110	KENDAL	136		
LUNGA	114	VOLGA	62	LAGOAS	163		
MAAS	60	VOLTURNO	104	LENNON	183		
MACKENZIE	22	WITHAM	26	MACAPA	168		
MALAWI	148	YAMUNA	50	MELO	172		
MARIZA	16	YANGTZE	45	MOLINA	128		
MARNE	28			MOOD	176		

# Produktübersicht · Product Overview

Aperçu des produits · Productoverzicht · Descripción del producto ·

Panoramica prodotto · Vizualizare produs · Tuotteen yleiskuvaus · Przegląd produktów



MURES  
76



MACKENZIE  
22



FRASER  
72



MARIZA  
16



DAWSON  
29



MARNE  
28



FUERTE  
24



OHIO  
42



BEJA  
122



TRIOTO  
64



WITHAM  
26



PUELO  
134



PEARL  
30



KANSAS  
35



RAVI  
14



NESTOS  
12



YANGTZE  
45



CUANDO  
42



HORTON  
34



ELBE  
61



MAAS  
60



VOLGA  
62



TURIA  
50



YAMUNA  
50



PARANA  
51



THAMES  
40



THAMES II  
41



SALMON  
18



TRENT  
43



ADOUR  
38



COLORADO  
52



TAY  
52



ARDAS  
53



MAYENNE  
43



RENO  
32



COOPER  
70

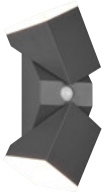

AVON  
36



ROYA  
58



ROYA  
56



TIBER  
53



KAVERI  
54



BENI  
55



BRAGA  
124



ADAJA  
40



CORDOBA  
126



ROSARIO  
127



FUNCHAL  
132



KANSAS  
35



TAWA  
39



CUSCO  
125



BARCELOS  
131



AMBATO  
131



PUNO  
129



FORTALEZA  
130



TAGUS  
20



HOOSIC  
78



HOOSIC  
84



MOLINA  
128



MOLINA  
128



SINTRA  
135



MERSEY  
44



KASAI  
44



SALMON  
18



ARDILA  
68



ARDILA  
66



ALMERIA  
139



BONITO  
138



GARONNE  
95



GARONNE  
96



VENTA  
110



INDUS  
48



TIMOK  
48

# Produktübersicht · Product Overview

Aperçu des produits · Productoverzicht · Descripción del producto ·

Panoramica prodotto · Vizualizare produs · Tuotteen yleiskuvaus · Przegląd produktów



KONDA  
45



KENDAL  
136



TUMEN  
100



BREG  
49



KENDAL  
136



CAMARO  
136



PIAVE  
47



BERMEJO  
46

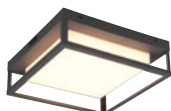

WITHAM  
26



GARONNE  
96



SAMBESI  
90



TANARO  
113



LUNGA  
114



OLONA  
112



CAVADO  
88



RUVUMA  
98



DUERO  
114



NORMAN  
102



ATRATO  
103



BRENTA  
102



TANA  
101



MIRANDE  
115



ELVO  
106



VOLTURNO  
104



LIVENZA  
108



VENTA  
110



VOLGA  
62



RAVI  
14



NESTOS  
12



MARIZA  
16



WITHAM  
26



FUERTE  
24

## Sicherheit & Komfort / Sensorleuchten · Security & Comfort / Sensor Lights

Sécurité et confort / Lampes à détecteur · Veiligheid en comfort/sensorlampen · Seguridad & Comodidad / Luces del sensor ·

Sicurezza e confort / Lampade con sensore integrat · Siguranță & confort / Lumini senzor ·

Turvallisuus ja mukavuus/tunnistinvalaisimet · Bezpieczeństwo i komfort / światła z czujnikami



MURES  
76



PEARL  
31



ROYA  
56



MACKENZIE  
22



SALMON  
18



KAVERI  
54



BENI  
55



FRASER  
74



BEJA  
122



RENO  
32



COOPER  
70



TAGUS  
20



HOOSIC  
78



HOOSIC  
84



TRIOTO  
64



ARDILA  
66



ARDILA  
68



GARONNE  
95



RUVUMA  
98



HUDSON  
86



SAMBESI  
90



CAVADO  
88



ELVO  
106



VOLTURNO  
104



LIVENZA  
108



VENTA  
110



CAVADO  
88



SAMBESI  
90



ELVO  
106



VOLTURNO  
104



LIVENZA  
108

## Spots, Einbauleuchten & Zubehör · Spotlights, Recessed luminaires & Accessories

Spots, lumières encastrées et accessoires · Spots, inbouwlampen en toebehoren · Puntos de luz, lámparas integradas y accesorios ·

Faretti, lampade da incasso e sensori · Spoturi, lămpi încorporate & accesorii · Kohdevalaisimet, upotettavat valaisimet ja tarvikkeet ·

Spoty, światła wpuszczane i akcesoria



BELAJA  
116



CACERES  
143

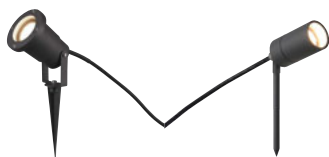

UBANGI  
117



PURUS  
143



BOLO  
142



FESTIVAL  
175



STICK  
140



SCOOP  
140



OBIDOS  
174



STECKDOSEN  
PLUG  
118



STECKDOSEN  
PLUG  
118



ERDSPIESS  
GROUND SPIKE  
119



ECKHALTERUNG  
CORNER FASTENING  
119

## Outdoor Living · Outdoor Living Lighting

Idées d'éclairage pour la vie en plein air · Lichtideeën voor buiten · Ideas de luz para la vida al aire libre ·

Idee di Illuminazione per l'Outdoor Living · Idei de iluminare pentru exterior · Outdoor Living -valaisinideat ·

Pomysły na oświetlenie zewnętrzne



ARUBA  
188



JAMAICA  
189



PALMAS  
186



DIAZ  
184



SUAREZ  
180



RICARDO  
185



LENNON  
183



FERNANDEZ  
182



MOOD  
177



CHAIN  
191



EMBER  
190

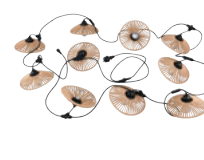

CHAIN  
191

# Solarleuchten · Solar Lights

Lampes solaires · Lampen op zonne-energie · Luces solares ·

Lampade solari · Lāmpi solare · Aurinkovalaisimet · Światła z zasilaniem słonecznym



MALAWI  
148



MALAWI  
148



BLYDE  
146



BLYDE  
146



GORDA  
152



GORDA  
152



COLOMBO  
150



COLOMBO  
150



MORO  
156



ATICO  
159



RAMOS  
158



COBRE  
157



ELVAS  
170



SILVES  
154



BILBAO  
155



FOMOSA  
167



SALTA  
167



LAGOAS  
163



TALCA  
171



OLINDA  
162



POSADAS  
164



ESQUEL  
164



POSADAS  
164



ESQUEL  
164



MACAPA  
168



ALVORADA  
158



MOURA  
166



VIAMAO  
162



DIADEMA  
168



ACORA  
169



MELO  
172



CAMPUS  
176



MOOD  
176



MOOD  
177

# NESTOS

Aluminium Druckguss, Kunststoff · Diecast aluminium, plastic ·  
 Fonte d'aluminium, plastique · Gegoten aluminium, kunststof ·  
 Aluminio fundido, plástico · Pressofusione di alluminio, plastica ·  
 Fonta aluminiu, plastic · Valualumiini, muov · Barwione aluminium, plastik



Bewegungssensor ·  
 Motion sensor

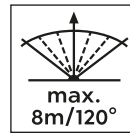

42 | Anthrazit · anthracite



Wandleuchte · Wall lamp  
 incl. SMD-LED  
 13 W / 1.300 Lumen  
 3.000 Kelvin  
**240960142**

Wandleuchte · Wall lamp  
 incl. SMD-LED  
 13 W / 1.300 Lumen  
 3.000 Kelvin  
**240969142**

Sockelleuchte · Podestal lamp  
 incl. SMD-LED  
 13 W / 1.300 Lumen  
 3.000 Kelvin  
**540969142**

Bodenleuchte · Floor lamp  
 incl. SMD-LED  
 13 W / 1.300 Lumen  
 3.000 Kelvin  
**440969142**

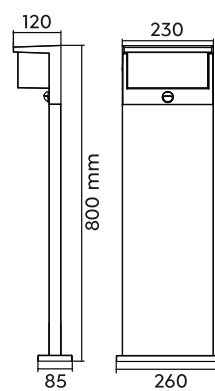
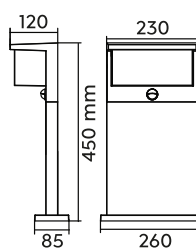
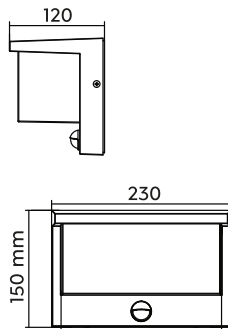
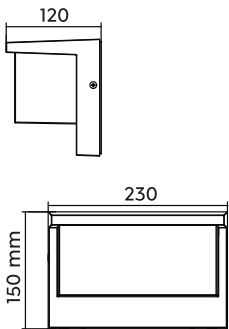



Aluminium Druckguss · Diecast aluminium ·  
 Fonte d'aluminium · Gegoten aluminium · Aluminio fundido ·  
 Pressofusione di alluminio · Fonta aluminii ·  
 Valualumiini · Barwione aluminium

 **42** | Anthrazit · anthracite



Bewegungssensor Multi-Control ·  
 Multi-Control motion sensor



Bewegungssensor und Orientierungslicht ·  
 Motion sensor and orientation light



Wandleuchte · Wall lamp  
 incl. SMD-LED  
 13 W / 1.500 Lumen  
 2.200 + 3.000 + 4.000 Kelvin  
**238660142**

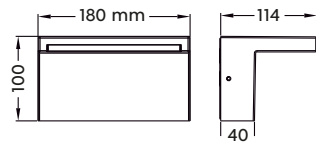

Wandleuchte · Wall lamp  
 incl. SMD-LED  
 13 W / 1.500 Lumen  
 2.200 + 3.000 + 4.000 Kelvin  
**238669142**

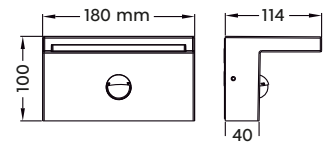

Sockelleuchte · Podestal lamp  
 incl. SMD-LED  
 13 W / 1.500 Lumen  
 2.200 + 3.000 + 4.000 Kelvin  
**538660142**

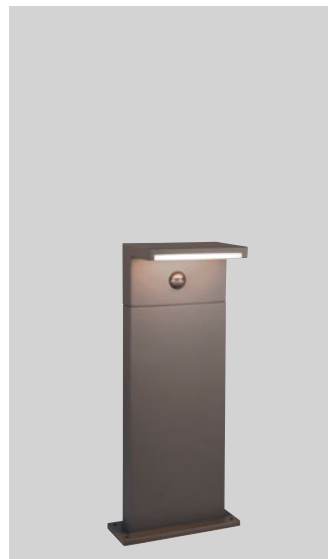
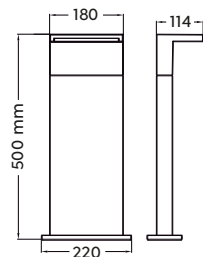

Sockelleuchte · Podestal lamp  
 incl. SMD-LED  
 13 W / 1.500 Lumen  
 2.200 + 3.000 + 4.000 Kelvin  
**538669142**

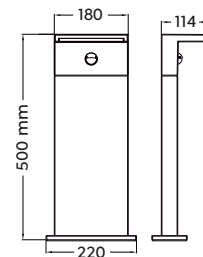

Bodenleuchte · Floor lamp  
 incl. SMD-LED  
 13 W / 1.500 Lumen  
 2.200 + 3.000 + 4.000 Kelvin  
**438660142**

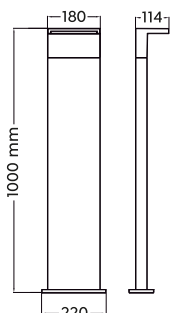

Bodenleuchte · Floor lamp  
 incl. SMD-LED  
 13 W / 1.500 Lumen  
 2.200 + 3.000 + 4.000 Kelvin  
**438669142**

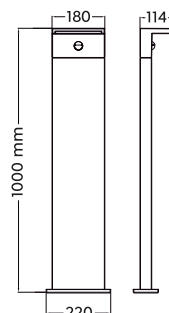



Lichtfarben direkt an der Leuchte einstellbar  
Colours directly adjustable at the lamp



Helligkeit einstellbar  
Adjustable light level



2.200 K



3.000 K



4.000 K

# MARIZA

Aluminium Druckguss, Glas · Diecast aluminium, glass ·  
 Fonte d'aluminium, verre · Gegoten aluminium, glas ·  
 Aluminio fundido, vidrio · Pressofusione di alluminio, vetro ·  
 Fonta aluminium, sticla · Valualumiini, lasi · Barwione aluminium, szkło

42 | Anthrazit · anthracite



Wandleuchte · Wall lamp  
 incl. SMD-LED  
 10 W / 1.100 Lumen  
 3.000 Kelvin  
**247060142**

IP65

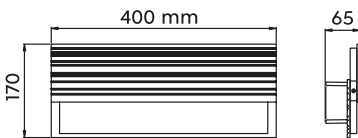

Sockelleuchte · Podestal lamp  
 incl. SMD-LED  
 11 W / 1.150 Lumen  
 3.000 Kelvin  
**547060142**

IP65

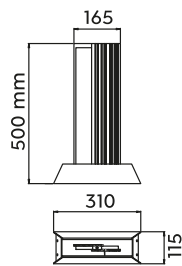

Bodenleuchte · Floor lamp  
 incl. SMD-LED  
 16 W / 1.800 Lumen  
 3.000 Kelvin  
**447060142**

IP65

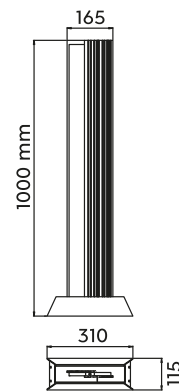

# MARIZA

Aluminium Druckguss, Glas · Diecast aluminium, glass ·  
Fonte d'aluminium, verre · Gegoten aluminium, glas ·  
Aluminio fundido, vidrio · Pressofusione di alluminio, vetro ·  
Fonta aluminiu, sticla · Valualumiini, lasi · Barwione aluminium, szkło



Bewegungssensor ·  
Motion sensor

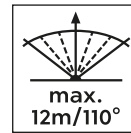

42 | Anthrazit · anthracite



Wandleuchte · Wall lamp

incl. SMD-LED  
10 W / 1.100 Lumen  
3.000 Kelvin  
247069142



IP44

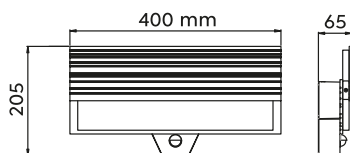

# SALMON

Aluminium Druckguss, Holznachbildung · Diecast aluminium, wood imitation ·  
 Fonte d'aluminium, imitation bois · Gegoten aluminium, houtimitatie ·  
 Aluminio fundido, imitación de madera · Pressofusione di alluminio, effetto legno ·  
 Fonta aluminiu, imitație de lemn · Valualumiini, puujäljitelmä ·  
 Barwione aluminium, imitacja drewna



Bewegungssensor ·  
 Motion sensor

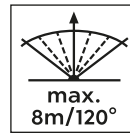

 **35** | Holznachbildung / Anthrazit · wood imitation / anthracite

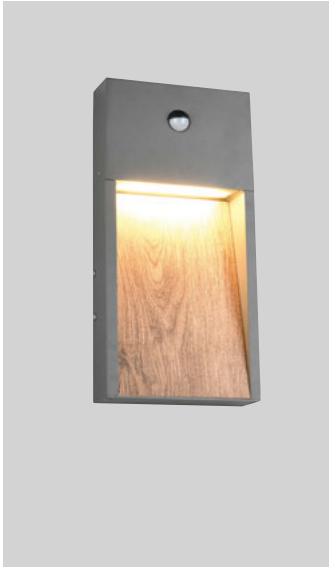

Wandleuchte · Wall lamp  
 incl. SMD-LED  
 11 W / 1.200 Lumen  
 3.000 Kelvin  
**246969135**

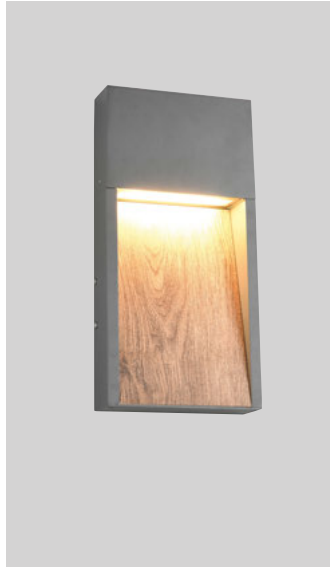
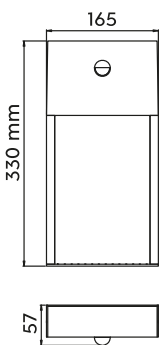

Wandleuchte · Wall lamp  
 incl. SMD-LED  
 11 W / 1.200 Lumen  
 3.000 Kelvin  
**246960135**

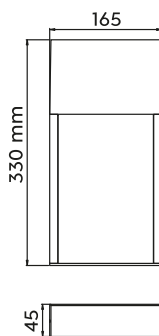

Sockelleuchte · Podestal lamp  
 incl. SMD-LED  
 11 W / 1.200 Lumen  
 3.000 Kelvin  
**546960135**

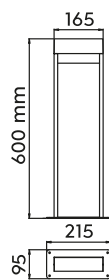

Bodenleuchte · Floor lamp  
 incl. SMD-LED  
 11 W / 1.200 Lumen  
 3.000 Kelvin  
**446960135**

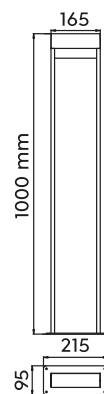



Aluminium Druckguss · Diecast aluminium ·  
 Fonte d'aluminium · Gegoten aluminium · Aluminio fundido ·  
 Pressofusione di alluminio · Fonta aluminii ·  
 Valualumiini · Barwione aluminium

 **42** | Anthrazit · anthracite



Bewegungssensor Multi-Control ·  
 Multi-Control motion sensor



Bewegungssensor und Orientierungslicht ·  
 Motion sensor and orientation light



Wandleuchte · Wall lamp  
 incl. SMD-LED  
 13 W / 1.500 Lumen  
 2.200 + 3.000 + 4.000 Kelvin  
**238560142**

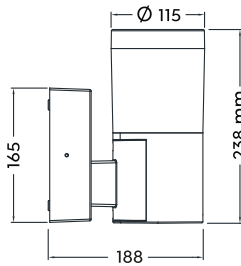

Wandleuchte · Wall lamp  
 incl. SMD-LED  
 13 W / 1.500 Lumen  
 2.200 + 3.000 + 4.000 Kelvin  
**238569142**

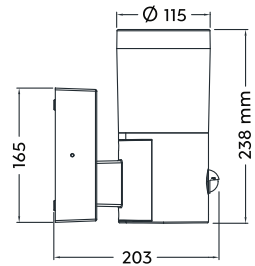

Sockelleuchte · Podestal lamp  
 incl. SMD-LED  
 13 W / 1.500 Lumen  
 2.200 + 3.000 + 4.000 Kelvin  
**538560142**

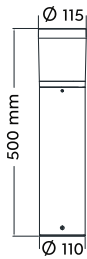

Sockelleuchte · Podestal lamp  
 incl. SMD-LED  
 13 W / 1.500 Lumen  
 2.200 + 3.000 + 4.000 Kelvin  
**538569142**



Bodenleuchte · Floor lamp  
 incl. SMD-LED  
 13 W / 1.500 Lumen  
 2.200 + 3.000 + 4.000 Kelvin  
**438560142**



Bodenleuchte · Floor lamp  
 incl. SMD-LED  
 13 W / 1.500 Lumen  
 2.200 + 3.000 + 4.000 Kelvin  
**438569142**





Lichtfarben direkt an der Leuchte einstellbar  
Colours directly adjustable at the lamp



Helligkeit einstellbar  
Adjustable light level



2.200 K



3.000 K



4.000 K

# MACKENZIE

Aluminium Druckguss, Kunststoff · Diecast aluminium, plastic ·  
 Fonte d'aluminium, plastique · Gegoten aluminium, kunststof ·  
 Aluminio fundido, plástico · Pressofusione di alluminio, plastica ·  
 Fonta aluminiu, plastic · Valualumiini, muovi · Barwione aluminium, plastik

42 | Anthrazit · anthracite



Wandleuchte · Wall lamp  
 incl. SMD-LED  
 8 W / 800 Lumen  
 3.000 Kelvin  
**230561142**

IP54

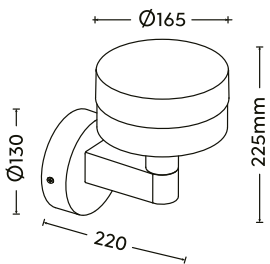

Sockelleuchte · Podestal lamp  
 incl. SMD-LED  
 8 W / 800 Lumen  
 3.000 Kelvin  
**530561142**

IP54

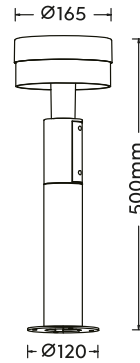

Bodenleuchte · Floor lamp  
 incl. SMD-LED  
 8 W / 800 Lumen  
 3.000 Kelvin  
**430561142**

IP54

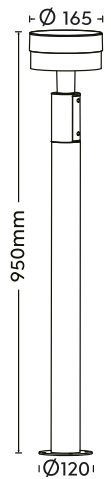

# MACKENZIE

Aluminium Druckguss, Kunststoff · Diecast aluminium, plastic ·  
Fonte d'aluminium, plastique · Gegoten aluminium, kunststof ·  
Aluminio fundido, plástico · Pressofusione di alluminio, plastica ·  
Fonta aluminiu, plastic · Valualumiini, muovii · Barwione aluminium, plastik



Bewegungssensor ·  
Motion sensor

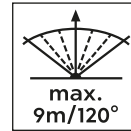

42 | Anthrazit · anthracite



Wandleuchte · Wall lamp  
incl. SMD-LED  
8 W / 800 Lumen  
3.000 Kelvin  
230569142



IP54

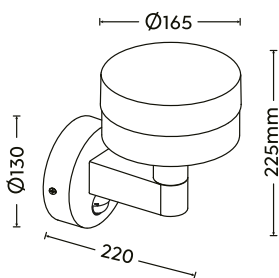

# FUERTE

Aluminium Druckguss, Acryl · Diecast aluminium, acryl ·  
 Fonte d'aluminium, acryl · Gegoten aluminium, acryl ·  
 Aluminio fundido, acrílico · Pressofusione di alluminio, acrilico ·  
 Fonta aluminiu, acrilic · Valualumiini, akryyli · Barwione aluminium, akryl

42 | Anthrazit · anthracite

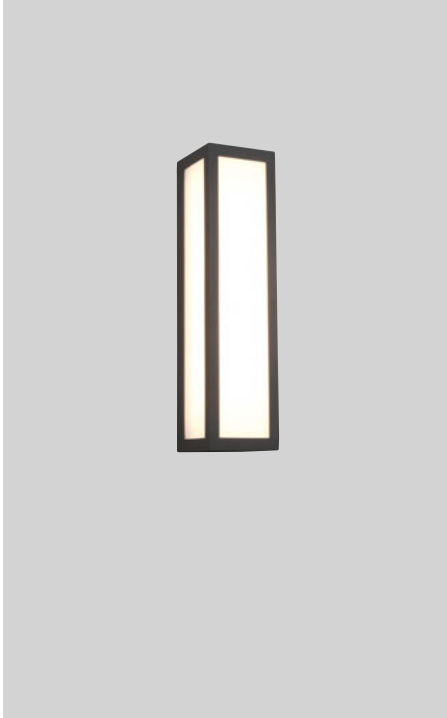

Wandleuchte · Wall lamp  
 incl. SMD-LED  
 10,5 W / 1.300 Lumen  
 3.000 Kelvin  
 2262601**42**

IP54

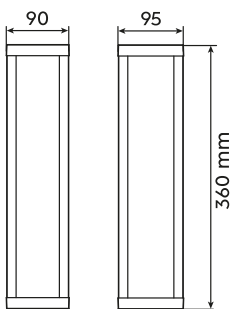

Sockelleuchte · Podestal lamp  
 incl. SMD-LED  
 15 W / 1.700 Lumen  
 3.000 Kelvin  
 5262601**42**

IP54

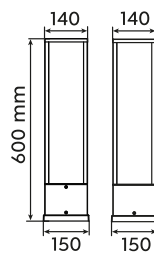

Bodenleuchte · Floor lamp  
 incl. SMD-LED  
 15 W / 1.700 Lumen  
 3.000 Kelvin  
 4262601**42**

IP54

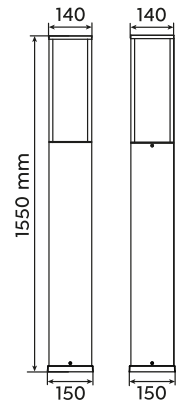





42 | Anthrazit · anthracite



Wandleuchte · Wall lamp  
 incl. SMD-LED  
 10,5 W / 1.100 Lumen  
 2.300 + 3.000 + 4.000 Kelvin  
**277860142**

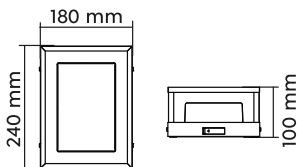

Deckenleuchte · Ceiling lamp  
 incl. SMD-LED  
 14 W / 1.550 Lumen  
 2.300 + 3.000 + 4.000 Kelvin  
**677860142**

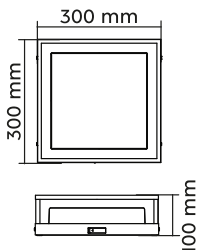

Sockelleuchte · Podestal lamp  
 incl. SMD-LED  
 14,5 W / 1.450 Lumen  
 2.300 + 3.000 + 4.000 Kelvin  
**577860142**

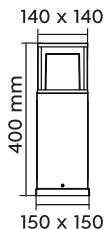

Bodenleuchte · Floor lamp  
 incl. SMD-LED  
 14,5 W / 1.450 Lumen  
 2.300 + 3.000 + 4.000 Kelvin  
**477860142**

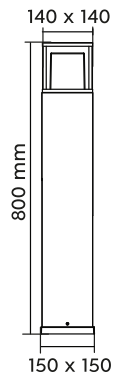



# MARNE

Aluminium Druckguss, Acryl · Diecast aluminium, acryl ·  
Fonte d'aluminium, acryl · Gegoten aluminium, acryl ·  
Aluminio fundido, acrílico · Pressofusione di alluminio, acrilico ·  
Fonta aluminiu, acrilic · Valualumiini, akryyli · Barwione aluminium, akryl

● 42 | Anthrazit · anthracite

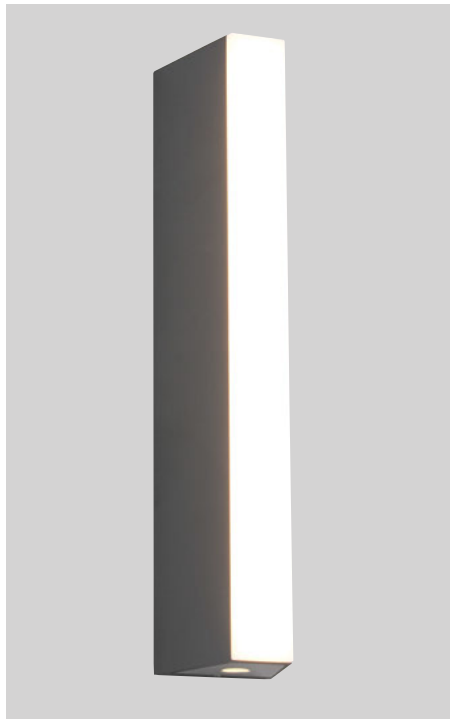

Wandleuchte · Wall lamp  
incl. SMD-LED  
8,5 W / 1.000 Lumen  
3.000 Kelvin  
**247360242**

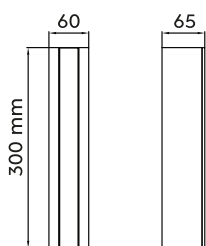

# DAWSON

Aluminium Druckguss, Acryl · Diecast aluminium, acryl ·  
 Fonte d'aluminium, acryl · Gegoten aluminium, acryl ·  
 Aluminio fundido, acrílico · Pressofusione di alluminio, acrilico ·  
 Fonta aluminiu, acrilic · Valualumiini, akryyli · Barwione aluminium, akryl



Lichtfarben direkt an der Leuchte einstellbar  
 Colours directly adjustable at the lamp

42 | Anthrazit · anthracite



Wandleuchte · Wall lamp  
 incl. SMD-LED  
 7 W / 800 Lumen  
 2.300 + 3.000 + 4.000 Kelvin  
**246360142**

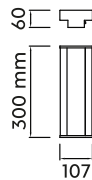

Wandleuchte · Wall lamp  
 incl. SMD-LED  
 8 W / 900 Lumen  
 2.300 + 3.000 + 4.000 Kelvin  
**246360242**

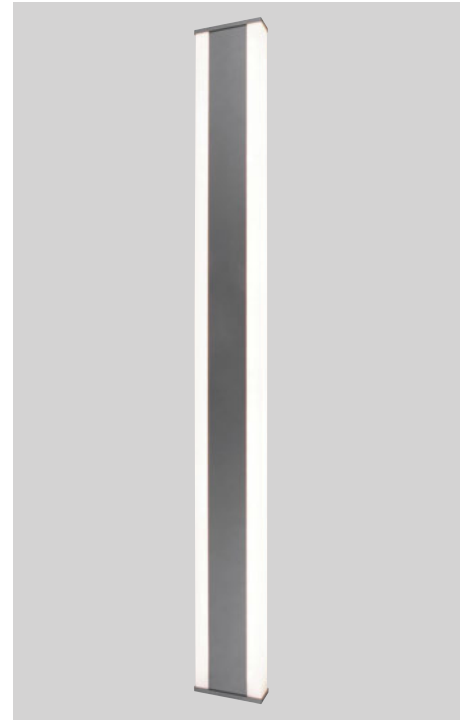

Wandleuchte · Wall lamp  
 incl. SMD-LED  
 11 W / 1.300 Lumen  
 2.300 + 3.000 + 4.000 Kelvin  
**246360342**

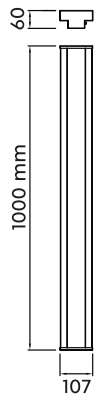

# PEARL

Aluminium Druckguss, Kunststoff · Diecast aluminium, plastic ·  
 Fonte d'aluminium, plastique · Gegoten aluminium, kunststof ·  
 Aluminio fundido, plástico · Pressofusione di alluminio, plastica ·  
 Fonta aluminiu, plastic · Valualumiini, muovi · Barwione aluminium, plastik

42 | Anthrazit · anthracite



Wandleuchte · Wall lamp  
 incl. SMD-LED  
 8 W / 900 Lumen  
 3.000 Kelvin  
**221160142**

⊕ IP54

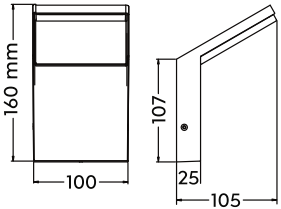

Sockelleuchte · Podestal lamp  
 incl. SMD-LED  
 8 W / 900 Lumen  
 3.000 Kelvin  
**521160142**

⊕ IP54

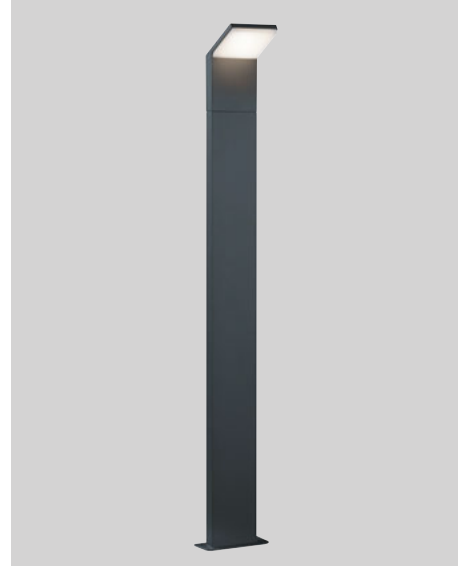
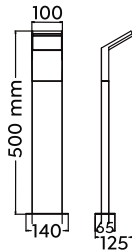

Bodenleuchte · Floor lamp  
 incl. SMD-LED  
 8 W / 900 Lumen  
 3.000 Kelvin  
**421160142**

⊕ IP54

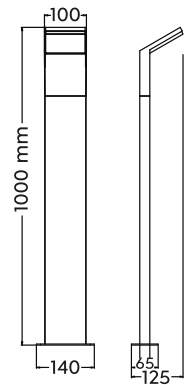

# PEARL

Aluminium Druckguss, Kunststoff · Diecast aluminium, plastic ·  
 Fonte d'aluminium, plastique · Gegoten aluminium, kunststof ·  
 Aluminio fundido, plástico · Pressofusione di alluminio, plastica ·  
 Fonta aluminiu, plastic · Valualumiini, muovi · Barwione aluminium, plastik



Bewegungssensor ·  
 Motion sensor

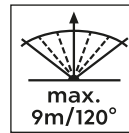

● 42 | Anthrazit · anthracite



Wandleuchte · Wall lamp  
 incl. SMD-LED  
 8 W / 900 Lumen  
 3.000 Kelvin  
**221169142**

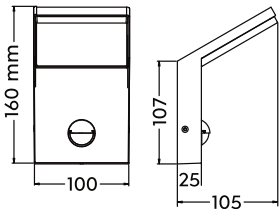

Sockelleuchte · Podestal lamp  
 incl. SMD-LED  
 8 W / 900 Lumen  
 3.000 Kelvin  
**521169142**

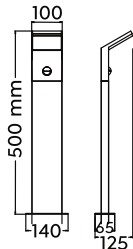

Bodenleuchte · Floor lamp  
 incl. SMD-LED  
 8 W / 900 Lumen  
 3.000 Kelvin  
**421169142**

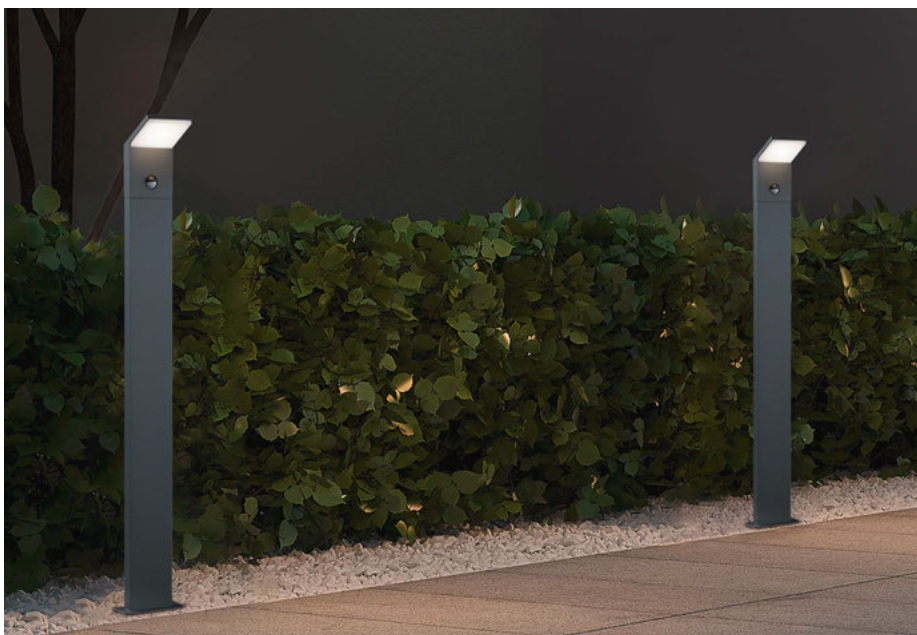
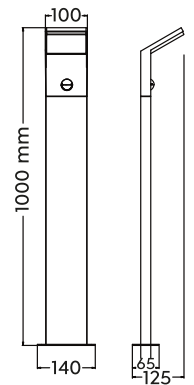

# RENO

Aluminium Druckguss · Diecast aluminium ·  
Fonte d'aluminium · Gegoten aluminium · Aluminio fundido  
Pressofusione di alluminio · Fonta aluminii · Valualumiini · Barwione aluminium

42 | Anthrazit · anthracite



Wandleuchte · Wall lamp  
incl. COB-LED  
4,5 W / 450 Lumen  
3.000 Kelvin  
2207601**42**

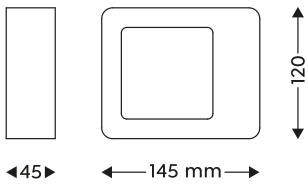

Sockelleuchte · Podestal lamp  
incl. COB-LED  
4,5 W / 450 Lumen  
3.000 Kelvin  
5207601**42**

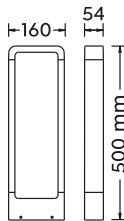

Bodenleuchte · Floor lamp  
incl. COB-LED  
4,5 W / 450 Lumen  
3.000 Kelvin  
4207601**42**

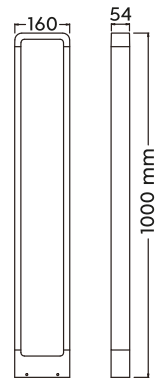



# HORTON

Aluminium Druckguss · Diecast aluminium ·  
 Fonte d'aluminium · Gegoten aluminium · Aluminio fundido  
 Pressofusione di alluminio · Fonta aluminu · Valualumiini · Barwione aluminium



Bewegungssensor ·  
 Motion sensor

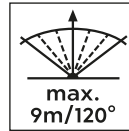

42 | Anthrazit · anthracite



Wandleuchte · Wall lamp  
 incl. SMD-LED  
 8 W / 1.000 Lumen  
 3.000 Kelvin  
**226360142**

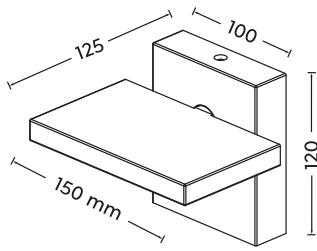

Wandleuchte · Wall lamp  
 incl. SMD-LED  
 8 W / 1.000 Lumen  
 3.000 Kelvin  
**226369142**

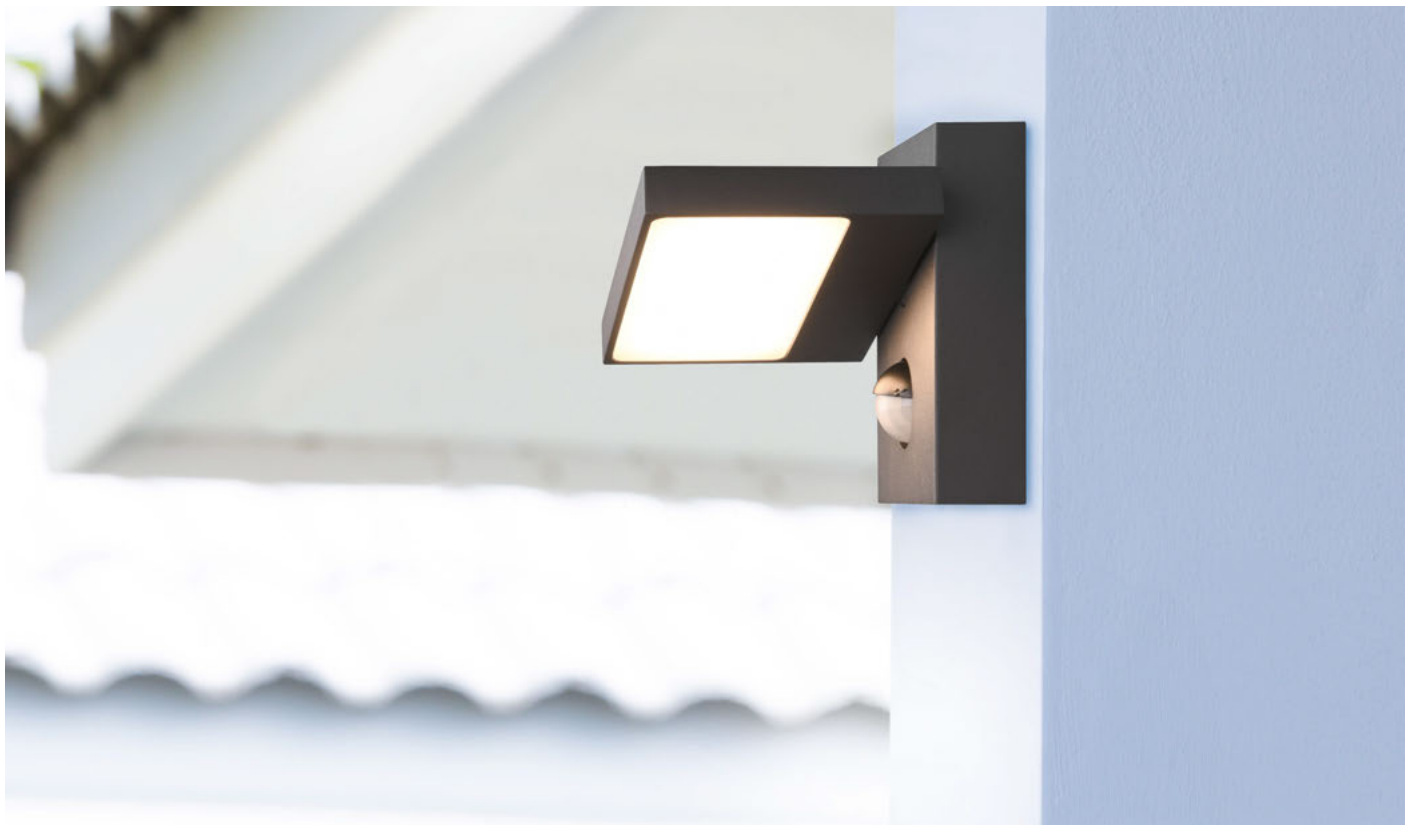
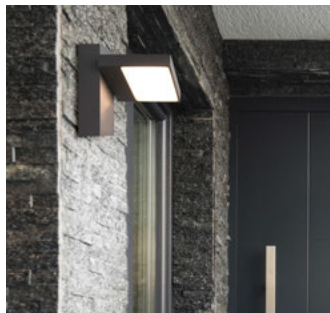
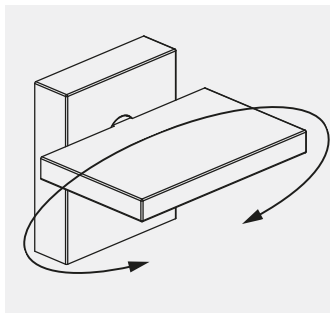
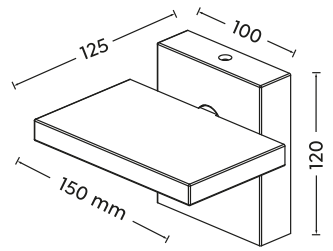

# KANSAS

Aluminium Druckguss, Acryl · Diecast aluminium, acryl ·  
 Fonte d'aluminium, acryl · Gegoten aluminium, acryl ·  
 Aluminio fundido, acrílico · Pressofusione di alluminio, acrilico ·  
 Fonta aluminiu, acrilic · Valualumiini, akryyli · Barwione aluminium, akryl



Bewegungssensor ·  
 Motion sensor

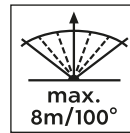

42 | Anthrazit · anthracite



Wandleuchte · Wall lamp  
 incl. SMD-LED  
 10 W / 1.000 Lumen  
 3.000 Kelvin  
**246860142**

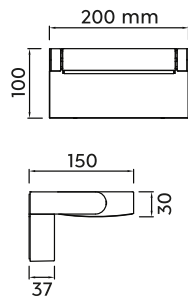

Wandleuchte · Wall lamp  
 incl. SMD-LED  
 10 W / 1.000 Lumen  
 3.000 Kelvin  
**246869142**

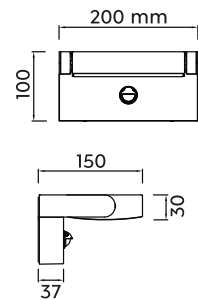

# AVON

Aluminium Druckguss, Acryl · Diecast aluminium, acryl ·  
Fonte d'aluminium, acryl · Gegoten aluminium, acryl ·  
Aluminio fundido, acrílico · Pressofusione di alluminio, acrilico ·  
Fonta aluminiu, acrilic · Valualumiini, akryyli · Barwione aluminium, akryl

42 | Anthrazit · anthracite

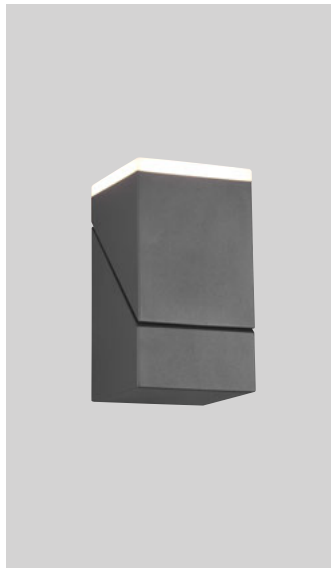

Wandleuchte · Wall lamp  
incl. SMD-LED  
7 W / 800 Lumen  
3.000 Kelvin  
**270660142**

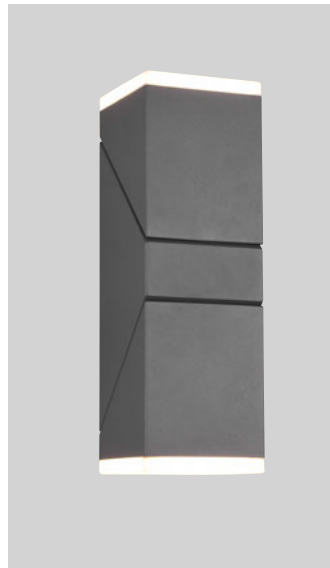
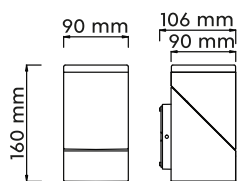

Wandleuchte · Wall lamp  
incl. 2 x SMD-LED  
2 x 7 W / 2 x 800 Lumen  
3.000 Kelvin  
**270660242**

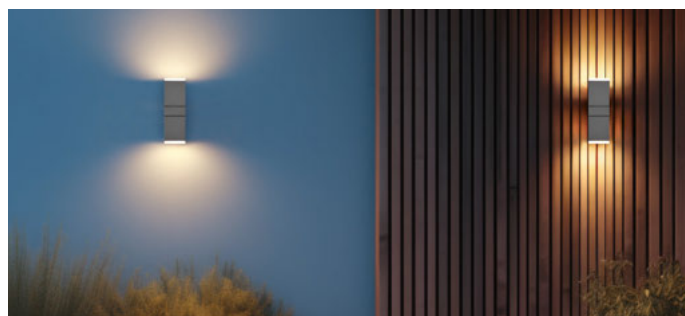
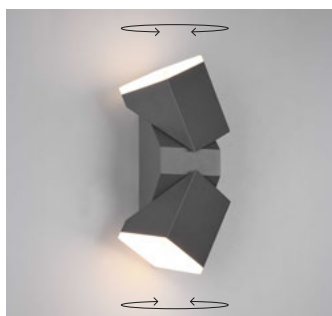
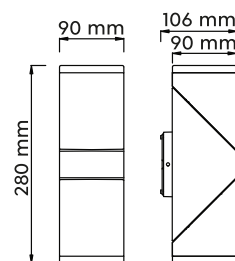

# AVON

Aluminium Druckguss, Acryl · Diecast aluminium, acryl ·  
 Fonte d'aluminium, acryl · Gegoten aluminium, acryl ·  
 Aluminio fundido, acrílico · Pressofusione di alluminio, acrilico ·  
 Fonta aluminiu, acrilic · Valualumiini, akryyli · Barwione aluminium, akryl

● 42 | Anthrazit · anthracite



Bewegungssensor ·  
 Motion sensor



Bewegungssensor und Orientierungslicht ·  
 Motion sensor and orientation light

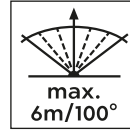

Wandleuchte · Wall lamp  
 incl. SMD-LED  
 7 W / 800 Lumen  
 3.000 Kelvin  
**270660142**

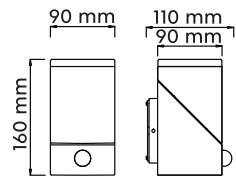

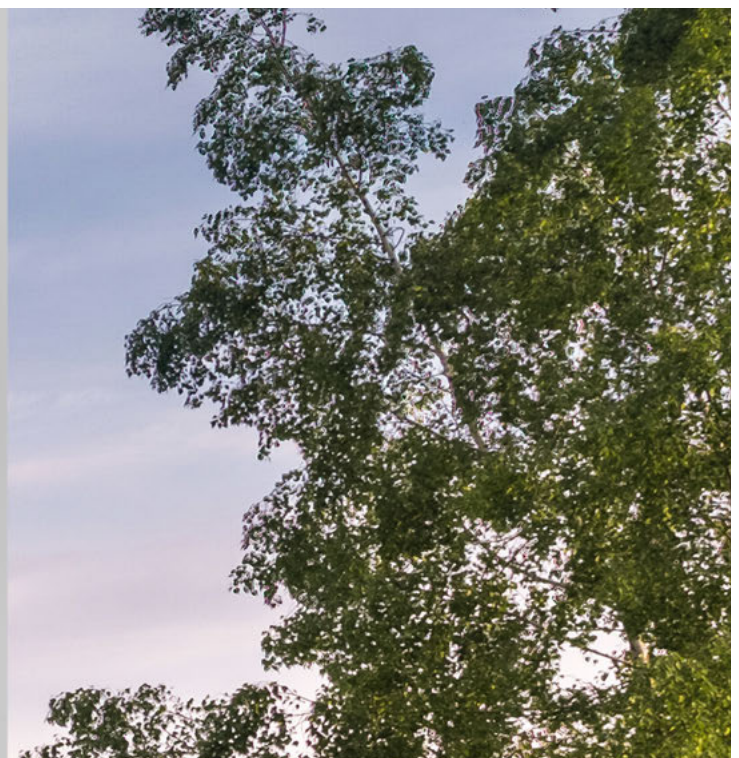
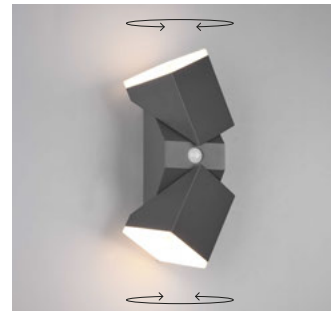
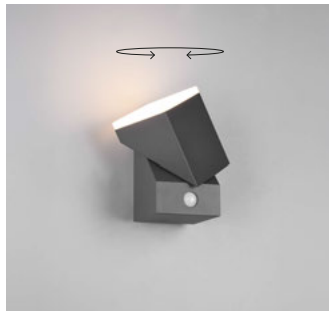
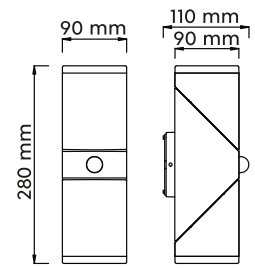

Wandleuchte · Wall lamp  
 incl. 2 x SMD-LED  
 2 x 7 W / 2 x 800 Lumen  
 3.000 Kelvin  
**270660242**



# ADOUR

Aluminium Druckguss, Acryl · Diecast aluminium, acryl ·  
 Fonte d'aluminium, acryl · Gegoten aluminium, acryl ·  
 Aluminio fundido, acrílico · Pressofusione di alluminio, acrilico ·  
 Fonta aluminiu, acrilic · Valualumiini, akryyli · Barwione aluminium, akryl

 DIP SWITCH

 Bewegungssensor ·  
 Motion sensor

 Kippbar ·  
 Tilttable

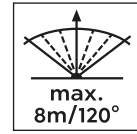

 42 | Anthrazit · anthracite



Wandleuchte · Wall lamp  
 incl. SMD-LED  
 7,5 W / 750 Lumen  
 2.300 + 3.000 + 4.000 Kelvin  
**245560142**

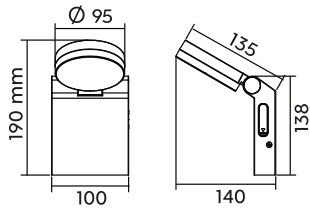

Wandleuchte · Wall lamp  
 incl. SMD-LED  
 7,5 W / 750 Lumen  
 2.300 + 3.000 + 4.000 Kelvin  
**245569142**

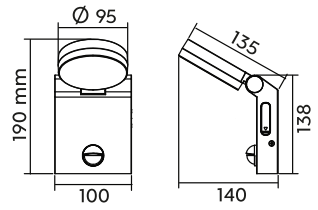

# TAWA

Aluminium Druckguss · Diecast aluminium ·  
Fonte d'aluminium · Gegoten aluminium · Aluminio fundido  
Pressofusione di alluminio · Fonta aluminiu · Valualumiini · Barwione aluminium

42 | Anthrazit · anthracite

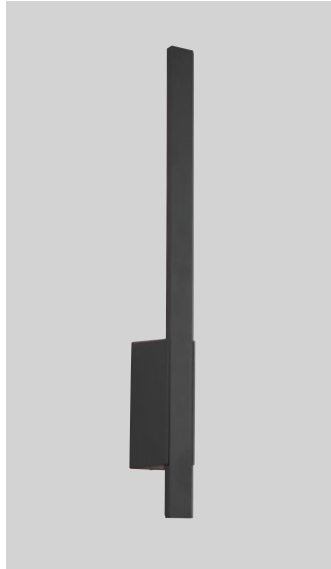

Wandleuchte · Wall lamp  
incl. SMD-LED  
7,5 W / 800 Lumen  
3.000 Kelvin  
**221460142**

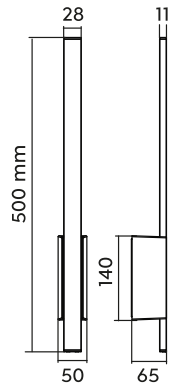

Wandleuchte · Wall lamp  
incl. 2 x SMD-LED  
2 x 9 W / 2 x 900 Lumen  
3.000 Kelvin  
**221460242**

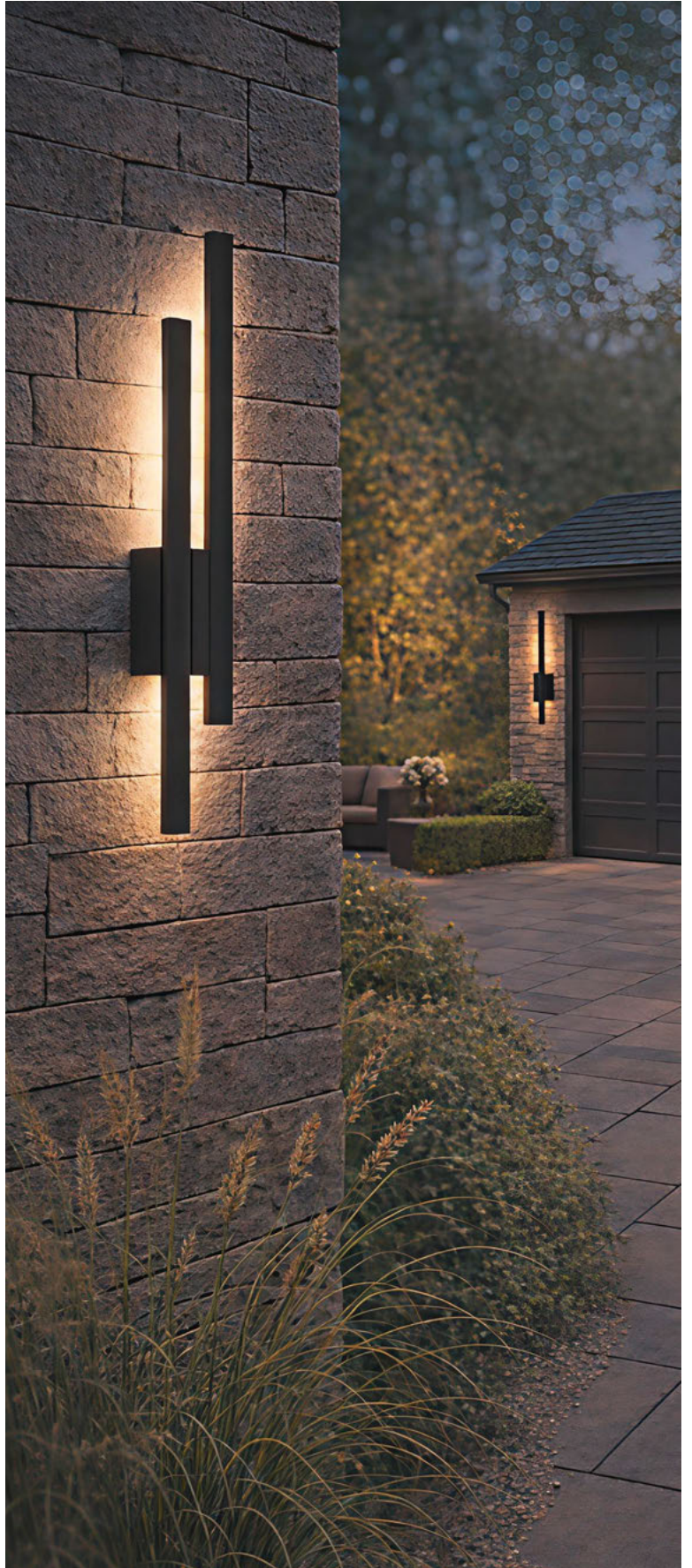
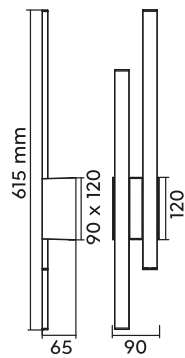

# ADAJA

Aluminium Druckguss · Diecast aluminium ·  
Fonte d'aluminium · Gegoten aluminium · Aluminio fundido  
Pressofusione di alluminio · Fonta aluminii · Valualumiini ·  
Barwione aluminium

42 | Anthrazit · anthracite



Wandleuchte · Wall lamp  
incl. 2 x SMD-LED  
2 x 3 W / 2 x 350 Lumen  
3.000 Kelvin  
**226860242**

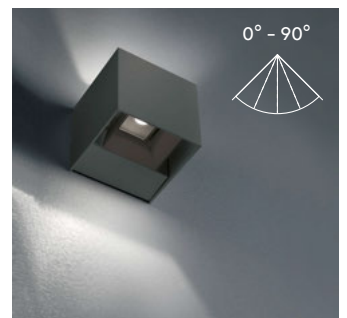
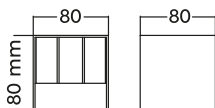

# THAMES

Aluminium Druckguss · Diecast aluminium ·  
Fonte d'aluminium · Gegoten aluminium · Aluminio fundido  
Pressofusione di alluminio · Fonta aluminii · Valualumiini ·  
Barwione aluminium

42 | Anthrazit · anthracite



Wandleuchte · Wall lamp  
incl. 2 x SMD-LED  
2 x 3 W / 2 x 340 Lumen  
3.000 Kelvin  
**229360242**

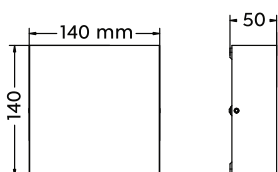

# THAMES II

Aluminium Druckguss · Diecast aluminium ·  
 Fonte d'aluminium · Gegoten aluminium · Aluminio fundido  
 Pressofusione di alluminio · Fonta aluminiu · Valualumiini · Barwione aluminium

○ 31 | Weiß matt · white mat

● 42 | Anthrazit · anthracite



Wandleuchte · Wall lamp  
 incl. 2 x SMD-LED  
 2 x 2,5 W / 2 x 260 Lumen  
 3.000 Kelvin  
**227560231**  
**227560242**

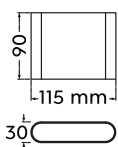

Wandleuchte · Wall lamp  
 incl. 2 x SMD-LED  
 2 x 4,5 W / 2 x 450 Lumen  
 3.000 Kelvin  
**227660231**  
**227660242**

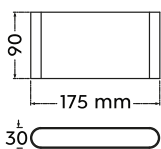

Wandleuchte · Wall lamp  
 incl. 2 x SMD-LED  
 2 x 8 W / 2 x 800 Lumen  
 3.000 Kelvin  
**226460242**

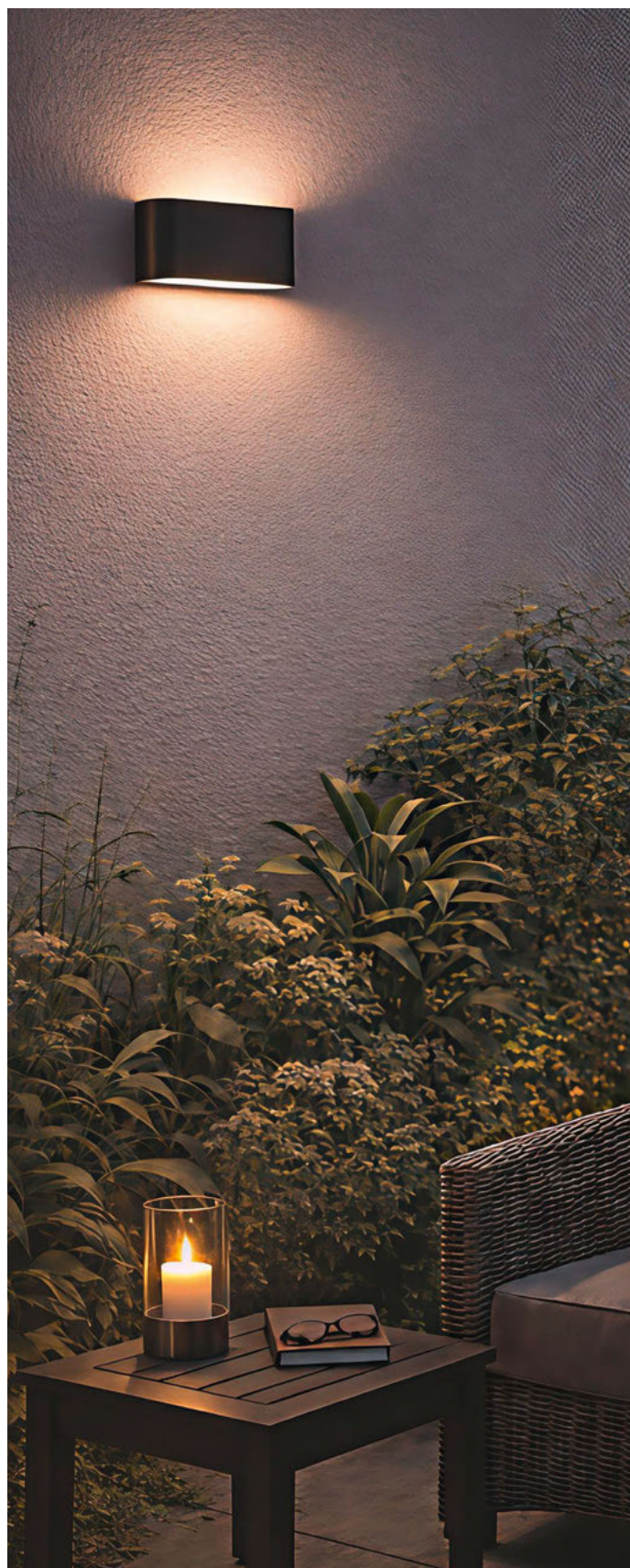
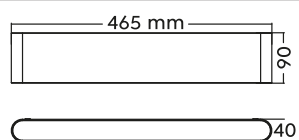

# CUANDO

Aluminium Druckguss, Acryl · Diecast aluminium, acryl ·  
 Fonte d'aluminium, acryl · Gegoten aluminium, acryl ·  
 Aluminio fundido, acrílico · Pressofusione di alluminio, acrilico ·  
 Fonta aluminiu, acrilic · Valualumiini, akryyli · Barwione aluminium, akryl

42 | Anthrazit · anthracite



Bewegungssensor ·  
 Motion sensor



Wandleuchte · Wall lamp  
 incl. SMD-LED  
 11 W / 1.400 Lumen  
 3.000 Kelvin  
**226660242**

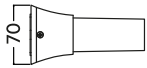
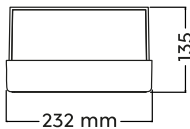

Wandleuchte · Wall lamp  
 incl. SMD-LED  
 11 W / 1.400 Lumen  
 3.000 Kelvin  
**226669242**

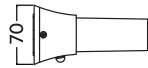
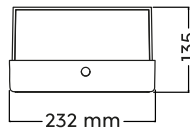

# OHIO

Aluminium Druckguss, Kunststoff · Diecast aluminium, plastic ·  
 Fonte d'aluminium, plastique · Gegoten aluminium, kunststof ·  
 Aluminio fundido, plástico · Pressofusione di alluminio, plastica ·  
 Fonta aluminiu, plastic · Valualumiini, muov · Barwione aluminium, plastik

42 | Anthrazit · anthracite



Bewegungssensor ·  
 Motion sensor

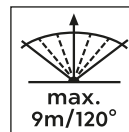

Wandleuchte · Wall lamp  
 incl. SMD-LED  
 7,5 W / 800 Lumen  
 3.000 Kelvin  
**220969142**

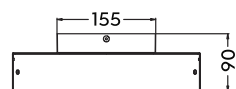
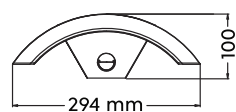

# TRENT

Aluminium Druckguss · Diecast aluminium ·  
 Fonte d'aluminium · Gegoten aluminium · Aluminio fundido  
 Pressofusione di alluminio · Fonta aluminiu · Valualumiini · Barwione aluminium

 **31** | Weiß matt · white mat

 **42** | Anthrazit · anthracite



Wandleuchte · Wall lamp  
 incl. SMD-LED  
 9 W / 1.100 Lumen  
 3.000 Kelvin  
**226960231**  
**226960242**

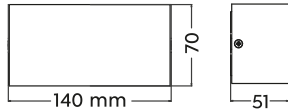

# MAYENNE

Aluminium Druckguss, Acryl · Diecast aluminium, acryl ·  
 Fonte d'aluminium, acryl · Gegoten aluminium, acryl ·  
 Aluminio fundido, acrílico · Pressofusione di alluminio, acrilico ·  
 Fonta aluminiu, acrilic · Valualumiini, akryyli · Barwione aluminium, akryl

 **31** | Weiß matt · white mat

 **35** | Holznachbildung · wood imitation

 **42** | Anthrazit · anthracite



Wandleuchte · Wall lamp  
 excl. 2 x E14  
 max. 10 W  
**218560231**  
**218560235**  
**218560242**

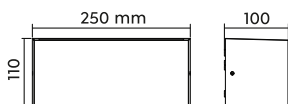

Empfohlen:  
 recommended:

Filament LED  
 E14, 4 W  
 470 lm, 2.700 K



**989-400**



# MERSEY

Aluminium Druckguss, Kunststoff · Diecast aluminium, plastic ·  
 Fonte d'aluminium, plastique · Gegoten aluminium, kunststof ·  
 Aluminio fundido, plástico · Pressofusione di alluminio, plastica ·  
 Fonta aluminiu, plastic · Valualumiini, muov · Barwione aluminium, plastik



Inkl. Hausnummern-Set ·  
 Incl. set of house numbers



Dämmerungssensor ·  
 Dusk sensor

42 | Anthrazit · anthracite



Wandleuchte · Wall lamp  
 excl. 2 x E14  
 max. 40 W  
**212160242**

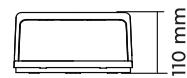
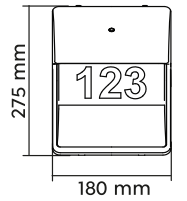

# KASAI

Aluminium Druckguss, Kunststoff · Diecast aluminium, plastic ·  
 Fonte d'aluminium, plastique · Gegoten aluminium, kunststof ·  
 Aluminio fundido, plástico · Pressofusione di alluminio, plastica ·  
 Fonta aluminiu, plastic · Valualumiini, muov · Barwione aluminium, plastik



Inkl. Hausnummern-Set ·  
 Incl. set of house numbers



Dämmerungssensor ·  
 Dusk sensor

42 | Anthrazit · anthracite



Wandleuchte · Wall lamp  
 incl. SMD-LED  
 9 W / 850 Lumen  
 3.000 Kelvin  
**228669142**

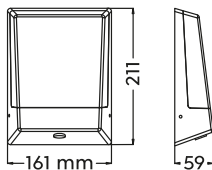

# KONDA

Aluminium Druckguss, Kunststoff · Diecast aluminium, plastic ·  
Fonte d'aluminium, plastique · Gegoten aluminium, kunststof ·  
Aluminio fundido, plástico · Pressofusione di alluminio, plastica ·  
Fonta aluminiu, plastic · Valualumiini, muovi · Barwione aluminium, plastik

● 42 | Anthrazit · anthracite



Wandleuchte · Wall lamp  
incl. SMD-LED  
9 W / 1.200 Lumen  
3.000 Kelvin  
**228560242**

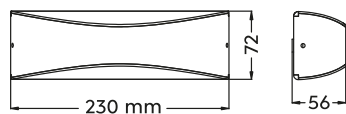

# YANGTZE

Aluminium Druckguss, Kunststoff · Diecast aluminium, plastic ·  
Fonte d'aluminium, plastique · Gegoten aluminium, kunststof ·  
Aluminio fundido, plástico · Pressofusione di alluminio, plastica ·  
Fonta aluminiu, plastic · Valualumiini, muovi · Barwione aluminium, plastik

● 42 | Anthrazit · anthracite



Wandleuchte · Wall lamp  
incl. SMD-LED  
4,5 W / 400 Lumen  
3.000 Kelvin  
**228260142**

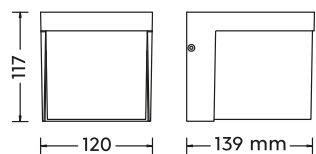

# BERMEJO

Metall, Kunststoff · Metal, plastic ·  
 Metale, plastique · Metaal, kunststof · Metal, plástico  
 Metallo, plastica · Metal, plastic · Metalli, muovi · Metal, plastik

● 42 | Anthrazit · anthracite



Bewegungssensor ·  
 Motion sensor



DIP SWITCH



Inkl. Hausnummern-Set ·  
 Incl. set of house numbers

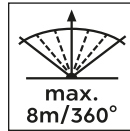

Wandleuchte · Wall lamp  
 incl. SMD-LED  
 14 W / 1.450 Lumen  
 2.300 + 3.000 + 4.000 Kelvin  
**630369142**

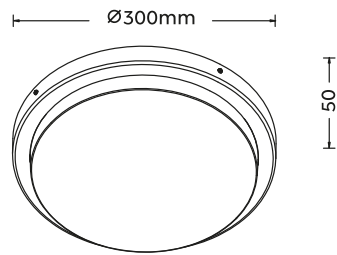

Wandleuchte · Wall lamp  
 incl. SMD-LED  
 14 W / 1.450 Lumen  
 2.300 + 3.000 + 4.000 Kelvin  
**630369242**

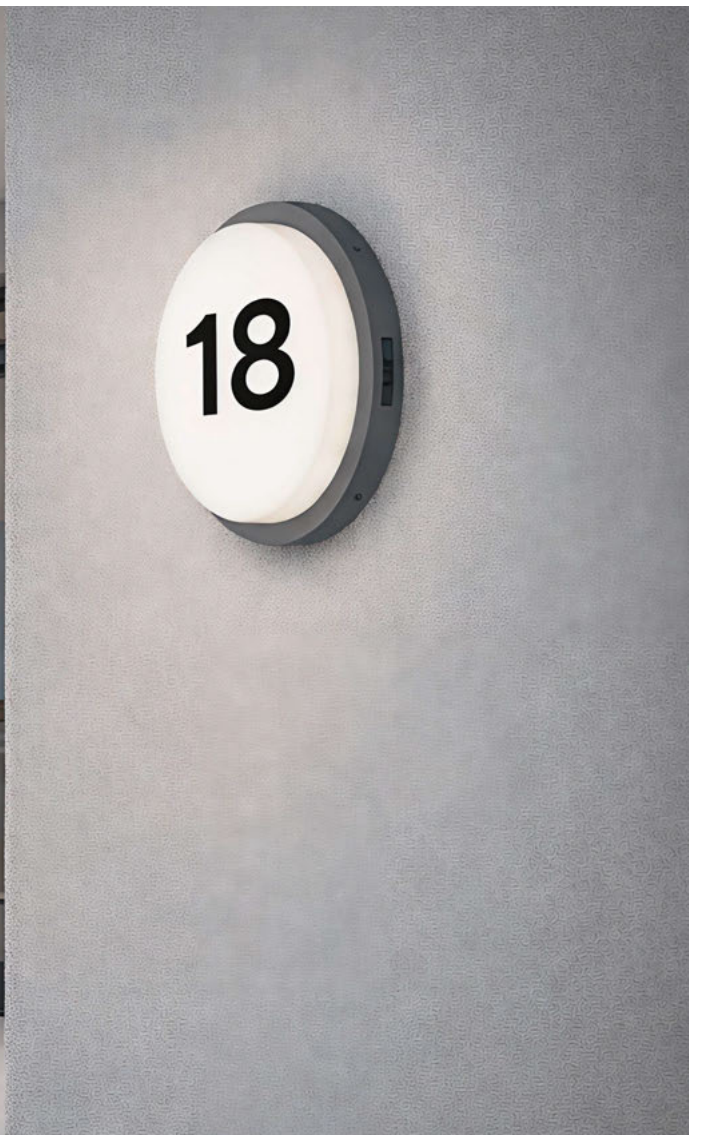
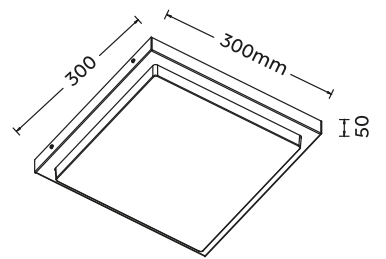

# PIAVE

Kunststoff · Plastic ·  
Plastique · Kunststoff · Plástico  
Plastica · Plastic · Muovi · Plastik

● 42 | Anthrazit · anthracite



Bewegungssensor ·  
Motion sensor

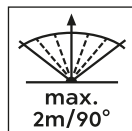

Wandleuchte · Wall lamp  
incl. SMD-LED  
11 W / 1.180 Lumen  
3.000 Kelvin  
**676960142**



IP54

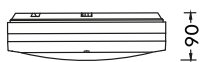
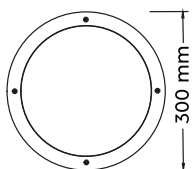

# TIMOK

Aluminium Druckguss, Kunststoff · Diecast aluminium, plastic ·  
Fonte d'aluminium, plastique · Gegoten aluminium, kunststof ·  
Aluminio fundido, plástico · Pressofusione di alluminio, plastica ·  
Fonta aluminiu, plastic · Valualumiini, muovi · Barwione aluminium, plastik

Incl.:

LED E27, 4,9 W  
470 lm, 3.000 K



42 | Anthrazit · anthracite



Wandleuchte · Wall lamp  
incl. LED E27  
4,9 W / 470 Lumen  
3.000 Kelvin  
**228060142**

IP54

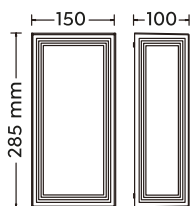

# INDUS

Aluminium Druckguss, Kunststoff · Diecast aluminium, plastic ·  
Fonte d'aluminium, plastique · Gegoten aluminium, kunststof ·  
Aluminio fundido, plástico · Pressofusione di alluminio, plastica ·  
Fonta aluminiu, plastic · Valualumiini, muovi · Barwione aluminium, plastik

42 | Anthrazit · anthracite



Wandleuchte · Wall lamp  
incl. 2 x SMD-LED  
2 x 4 W / 2 x 500 Lumen  
3.000 Kelvin  
**227360142**

IP54

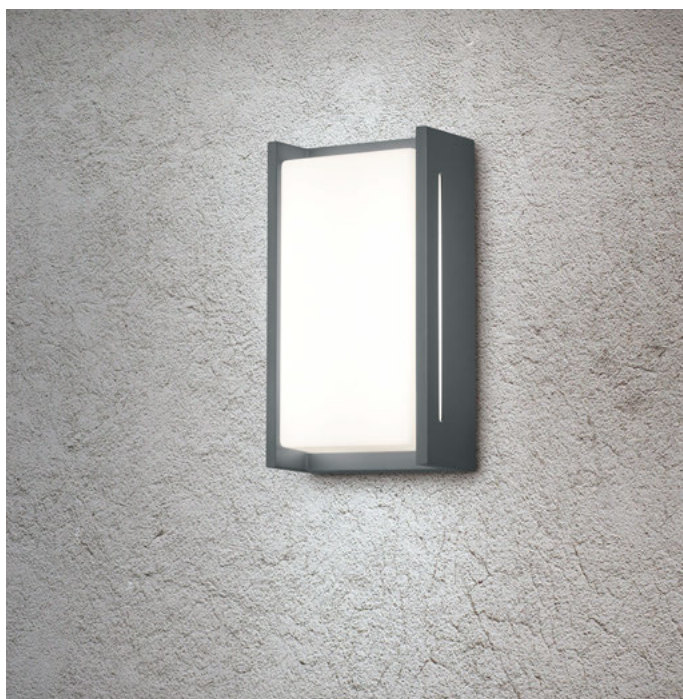
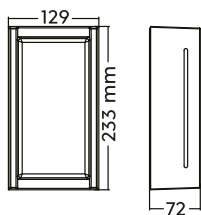

# BREG

Aluminium Druckguss, Kunststoff · Diecast aluminium, plastic ·  
Fonte d'aluminium, plastique · Gegoten aluminium, kunststof ·  
Aluminio fundido, plástico · Pressofusione di alluminio, plastica ·  
Fonta aluminiu, plastic · Valualumiini, muovii · Barwione aluminium, plastik

● 42 | Anthrazit · anthracite



Wandleuchte · Wall lamp  
incl. SMD-LED  
8,5 W / 850 Lumen  
3.000 Kelvin  
**227260142**

⊕ IP54

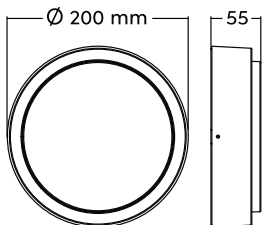

# TURIA

Aluminium Druckguss, Glas · Diecast aluminium, glass ·

Fonte d'aluminium, verre · Gegoten aluminium, glas · Aluminio fundido, vidrio ·

Pressofusione di alluminio, vetro · Fonta aluminii, sticla · Valualumiini, lasi · Barwione aluminium, szkło

24 | rostfarbig · rusty

31 | Weiß matt · white mat

42 | Anthrazit · anthracite



Wandleuchte · Wall lamp

excl. 2 x GU10  
max. 5 W

260260224

260260231

260260242

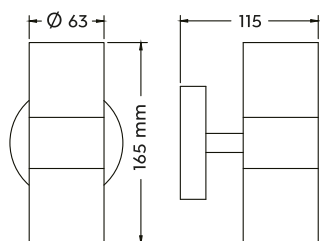

# YAMUNA



Aluminium Druckguss · Diecast aluminium ·

Fonte d'aluminium · Gegoten aluminium · Aluminio fundido

Pressofusione di alluminio · Fonta aluminii · Valualumiini · Barwione aluminium

24 | rostfarbig · rusty

31 | Weiß matt · white mat

42 | Anthrazit · anthracite



Wandleuchte · Wall lamp

excl. 2 x GU10  
max. 10 W

269760224

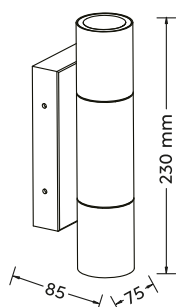

269760231

269760242



# PARANA

Aluminium Druckguss · Diecast aluminium ·  
 Fonte d'aluminium · Gegoten aluminium · Aluminio fundido  
 Pressofusione di alluminio · Fonta aluminiu · Valualumiini · Barwione aluminium

-  **31** | Weiß matt · white mat
-  **42** | Anthrazit · anthracite

Empfohlen:  
recommended:

LED GU10, 4,5 W  
 345 lm, 3.000 K  
 $\geq 36^\circ$



**956-5936**

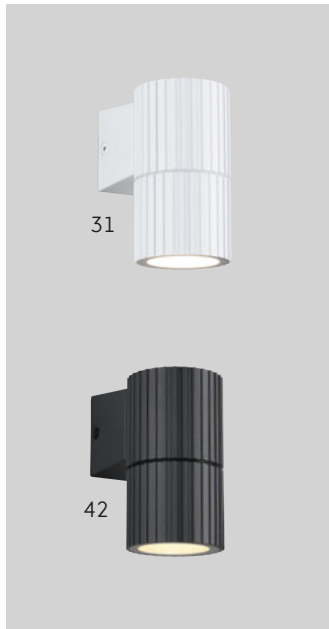

Wandleuchte · Wall lamp  
 excl. 1 x GU10  
 max. 5 W  
**269560131**  
**269560142**

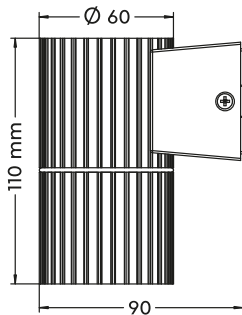

Wandleuchte · Wall lamp  
 excl. 2 x GU10  
 max. 5 W  
**269560231**  
**269560242**

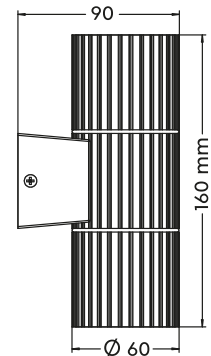

# TAY

Aluminium Druckguss · Diecast aluminium ·

Fonte d'aluminium · Gegoten aluminium · Aluminio fundido · Pressofusione di alluminio · Fonta aluminiu · Valualumiini · Barwione aluminium

42 | Anthrazit · anthracite



Wandleuchte · Wall lamp  
incl. 2 x SMD-LED  
2 x 4,5 W / 2 x 580 Lumen  
3.000 Kelvin  
**226560242**

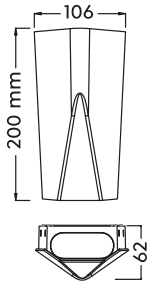

# COLORADO

Aluminium Druckguss · Diecast aluminium ·

Fonte d'aluminium · Gegoten aluminium · Aluminio fundido · Pressofusione di alluminio · Fonta aluminiu · Valualumiini · Barwione aluminium

42 | Anthrazit · anthracite



Wandleuchte · Wall lamp  
incl. 2 x SMD-LED  
2 x 3 W / 2 x 300 Lumen  
3.000 Kelvin  
**228460242**

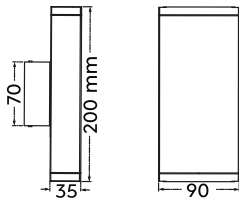

# ARDAS

Aluminium Druckguss, Glas · Diecast aluminium, glass ·

Fonte d'aluminium, verre · Gegoten aluminium, glas · Aluminio fundido, vidrio ·

Pressofusione di alluminio, vetro · Fonta aluminiu, sticla · Valualumiini, lasi · Barwione aluminium, szkło



32 | Schwarz matt · black mat

Empfohlen:  
recommended:

LED GU10, 4,9 W  
430 lm, 3.000 K  
≥ 110°



955-50



Wandleuchte · Wall lamp

excl. 2 x GU10

max. 10 W

212560**32**



IP44

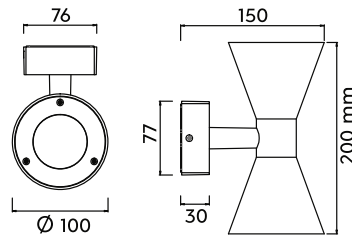

# TIBER

Aluminium Druckguss · Diecast aluminium ·

Fonte d'aluminium · Gegoten aluminium · Aluminio fundido · Pressofusione di alluminio · Fonta aluminiu · Valualumiini · Barwione aluminium



42 | Anthrazit · anthracite



Wandleuchte · Wall lamp

incl. SMD-LED

3 W / 300 Lumen

3.000 Kelvin

229160**142**



IP54

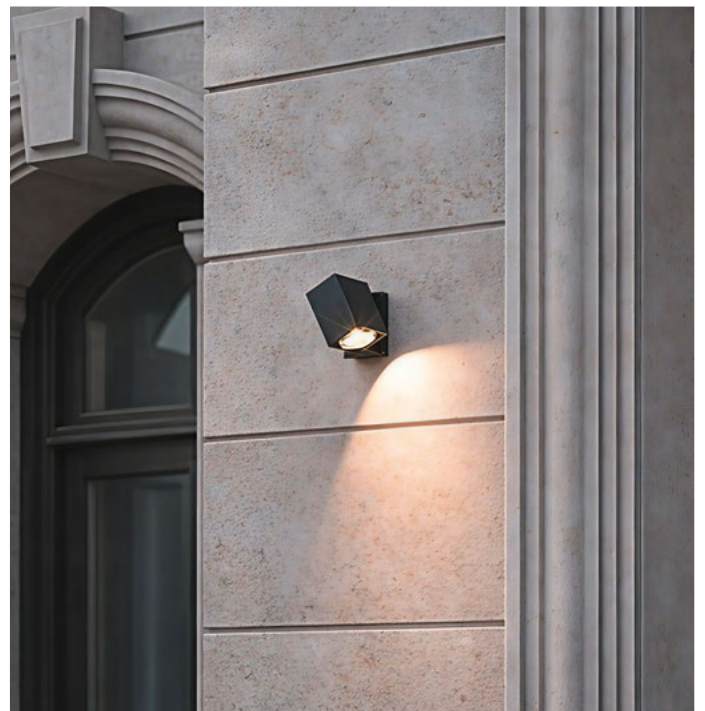
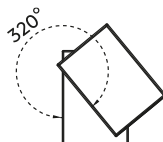
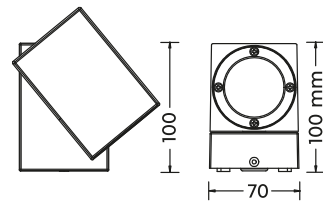

# KAVERI

Aluminium Druckguss · Diecast aluminium ·  
 Fonte d'aluminium · Gegoten aluminium · Aluminio fundido  
 Pressofusione di alluminio · Fonta aluminu · Valualumiini · Barwione aluminium

42 | Anthrazit · anthracite



Wandleuchte · Wall lamp  
 excl. 1 x GU10  
 max. 5 W  
**206060142**

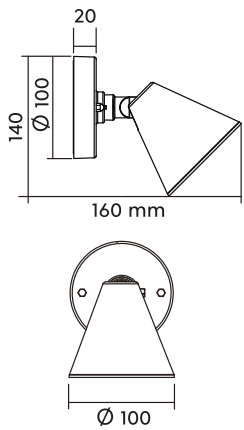

Sockelleuchte · Pedestal lamp  
 excl. 1 x GU10  
 max. 5 W  
**506060142**

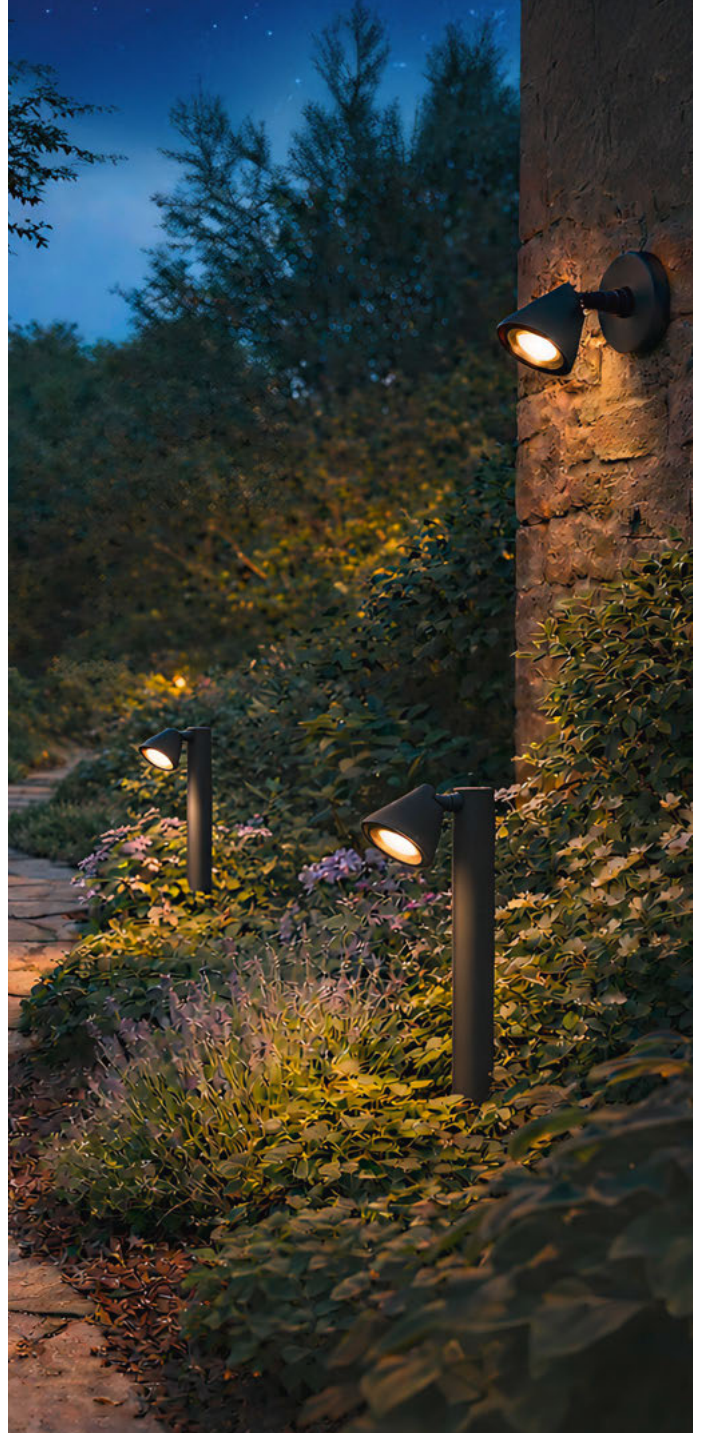
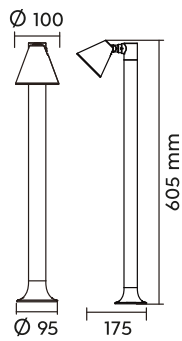

Empfohlen:  
 recommended:

LED GU10, 4,9 W  
 430 lm, 3.000 K  
 ≥ 110°

**955-50**



Metall, Glas · Metal, glass ·  
 Metale, verre · Metaal, glas · Metal, vidrio ·  
 Metallo, vetro · Metal, sticla · Metalli, lasi · Metal, szkło

 **31** | Weiß matt · white mat

 **42** | Anthrazit · anthracite

Empfohlen:  
recommended:

LED GU10, 4,5 W  
345 lm, 3.000 K  
≥ 36°



**956-5936**



Wandleuchte · Wall lamp

excl. 1 x GU10  
max. 5 W

**260360131**  
**260360142**

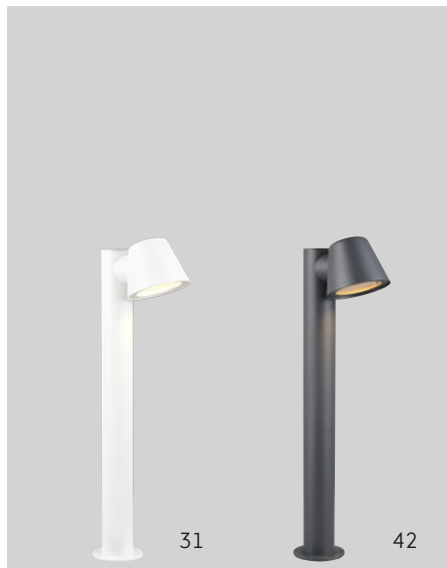
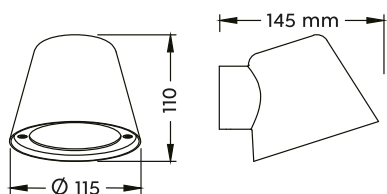

Sockelleuchte · Podestal lamp

excl. 1 x GU10  
max. 5 W

**560360131**  
**560360142**

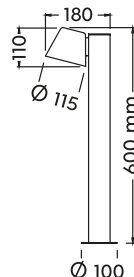

Bodenleuchte · Floor lamp

excl. 1 x GU10  
max. 5 W

**460360131**  
**460360142**

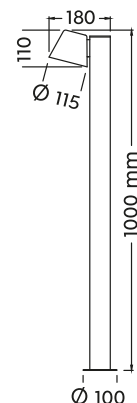

# ROYA

Aluminium Druckguss · Diecast aluminium ·  
 Fonte d'aluminium · Gegoten aluminium · Aluminio fundido ·  
 Pressofusione di alluminio · Fonta aluminii · Valualumiini ·  
 Barwione aluminium

● 42 | Anthrazit · anthracite



Bewegungssensor ·  
 Motion sensor

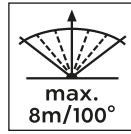

Empfohlen:  
 recommended:

LED GU10, 4,9 W  
 430 lm, 3.000 K  
 > 110°



955-50



Wandleuchte · Wall lamp  
 excl. 1 x GU10  
 max. 35 W  
 214260142

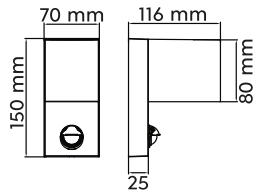

Wandleuchte · Wall lamp  
 excl. 1 x GU10  
 max. 35 W  
 214269142

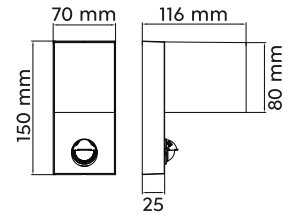

Wandleuchte · Wall lamp  
 excl. 2 x GU10  
 max. 35 W  
 214260242

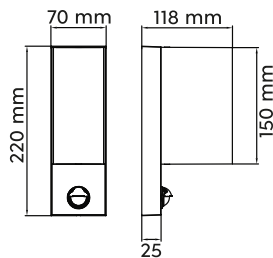

Wandleuchte · Wall lamp  
 excl. 2 x GU10  
 max. 35 W  
 214269242

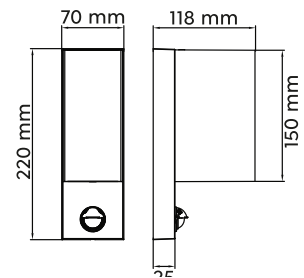

Sockelleuchte · Pedestal lamp  
 excl. 1 x GU10  
 max. 35 W  
 514260142

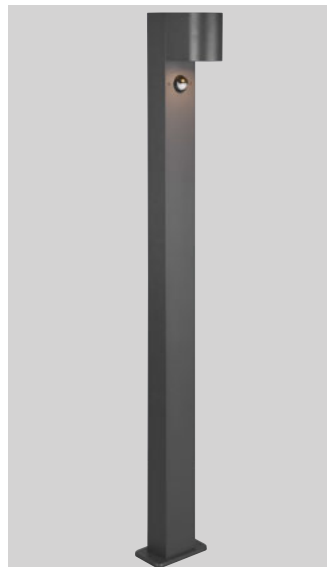
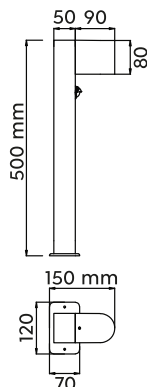

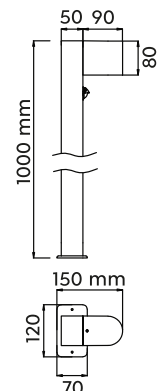

Bodenleuchte · Floor lamp  
 excl. 1 x GU10  
 max. 35 W  
 414260142





# ROYA

Aluminium Druckguss · Diecast aluminium ·  
 Fonte d'aluminium · Gegoten aluminium · Aluminio fundido ·  
 Pressofusione di alluminio · Fonta aluminiu · Valualumiini · Barwione aluminium

-  **24** | rostfarbig · rusty
-  **31** | Weiß matt · white mat
-  **42** | Anthrazit · anthracite

Empfohlen:  
 recommended:

LED GU10, 4,9 W  
 430 lm, 3.000 K  
 ≥ 110°



**955-50**



24



31



42

Wandleuchte · Wall lamp

excl. 2 x GU10  
 max. 35 W

2042602**24**  
 2042602**31**  
 2042602**42**

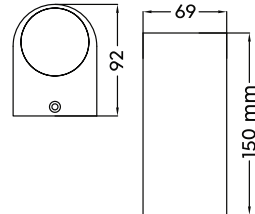

24



31



42

Wandleuchte · Wall lamp

excl. 2 x GU10  
 max. 35 W

2042692**24**  
 2042692**31**  
 2042692**42**

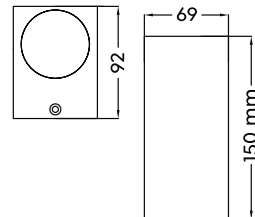

Sockelleuchte · Podestal lamp

excl. 1 x GU10  
 max. 20 W

5042601**42**

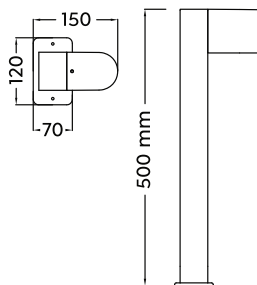

Bodenleuchte · Floor lamp

excl. 1 x GU10  
 max. 20 W

4042601**42**

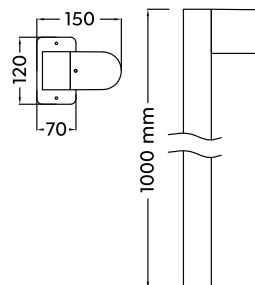



# MAAS

Aluminium Druckguss, Kunststoff · Diecast aluminium, plastic ·  
Fonte d'aluminium, plastique · Gegoten aluminium, kunststof ·  
Aluminio fundido, plástico · Pressofusione di alluminio, plastica ·  
Fonta aluminiu, plastic · Valualumiini, muovi · Barwione aluminium, plastik

 **15** | Grün · green

 **42** | Anthrazit · anthracite

 **24** | rostfarbig · rusty

 **66** | Sand · sable

 **40** | Apricot · apricot



Wandleuchte · Wall lamp

excl. 1 x E27  
max. 10 W

2624601**15**

2624601**24**

2624601**40**

2624601**42**

2624601**66**

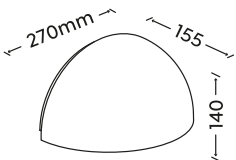

# ELBE

Aluminium Druckguss, Kunststoff · Diecast aluminium, plastic ·  
Fonte d'aluminium, plastique · Gegoten aluminium, kunststof ·  
Aluminio fundido, plástico · Pressofusione di alluminio, plastica ·  
Fonta aluminiu, plastic · Valualumiini, muovii · Barwione aluminium, plastik

 **15** | Grün · green

 **42** | Anthrazit · anthracite

 **24** | rostfarbig · rusty

 **66** | Sand · sable

 **40** | Apricot · apricot



Wandleuchte · Wall lamp

excl. 1 x E27  
max. 10 W

2623601**15**

2623601**24**

2623601**40**

2623601**42**

2623601**66**

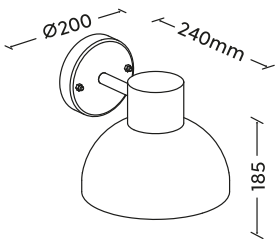

# VOLGA

Aluminium Druckguss, Kunststoff · Diecast aluminium, plastic ·  
 Fonte d'aluminium, plastique · Gegoten aluminium, kunststof ·  
 Aluminio fundido, plástico · Pressofusione di alluminio, plastica ·  
 Fonta aluminiu, plastic · Valualumiini, muov · Barwione aluminium, plastik

42 | Anthrazit · anthracite



Bewegungssensor ·  
 Motion sensor

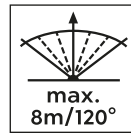

Wandleuchte · Wall lamp  
 excl. 1 x E27  
 max. 25 W  
**269469142**

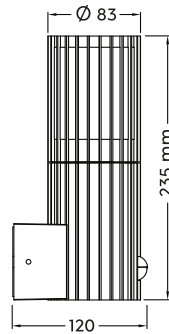

Wandleuchte · Wall lamp  
 excl. 1 x E27  
 max. 25 W  
**269460142**

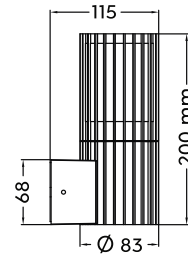

Wandleuchte · Wall lamp  
 excl. 2 x E27  
 max. 25 W  
**269460242**

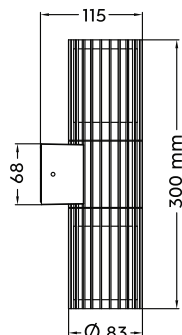

Bodenleuchte · Floor lamp  
 excl. 1 x E27  
 max. 25 W  
**469460142**

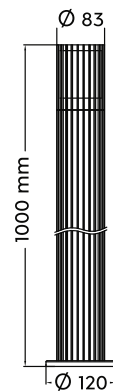

Sockelleuchte · Pedestal lamp  
 excl. 1 x E27  
 max. 25 W  
**569460142**





# TRIOTO

Edelstahl, Kunststoff · Steel, plastic ·  
 Acier, plastique · Staal, kunststof · Acero, plástico ·  
 Acciaio, plastica · Inox, plastic · Teräs, muovi · Stal, plastik



Bewegungssensor ·  
 Motion sensor

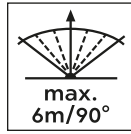

07 | Nickel matt · nickel mat

32 | Schwarz matt · black mat



Wandleuchte · Wall lamp  
 excl. 1 x E27  
 max. 25 W  
 209760107  
 209760132

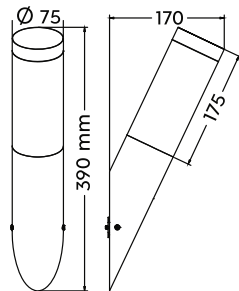

Wandleuchte · Wall lamp  
 excl. 1 x E27  
 max. 25 W  
 209769107  
 209769132

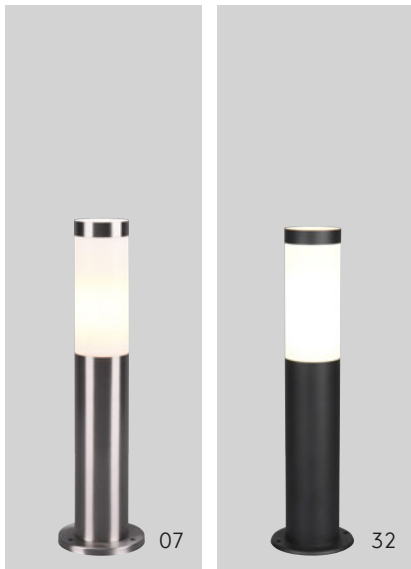
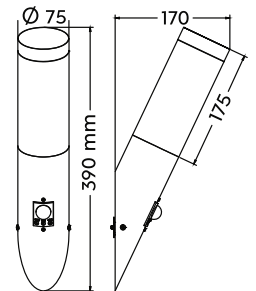

Sockelleuchte · Podestal lamp  
 excl. 1 x E27  
 max. 25 W  
 509760107  
 509760132

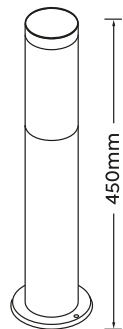

Bodenleuchte · Floor lamp  
 excl. 1 x E27  
 max. 25 W  
 409760107  
 409760132





# ARDILA

Aluminium Druckguss, Glas · Diecast aluminium, glass ·  
 Fonte d'aluminium, verre · Gegoten aluminium, glas ·  
 Aluminio fundido, vidrio · Pressofusione di alluminio, vetro ·  
 Fonta aluminiu, sticla · Valualumiini, lasi · Barwione aluminium, szkło

● 32 | Schwarz matt · black mat

Empfohlen:  
 recommended:

Filament LED  
 E27, 4 W  
 470 lm, 2.700 K



987-400



Wandleuchte · Wall lamp  
 excl. 1 x E27  
 max. 40 W  
 211660132

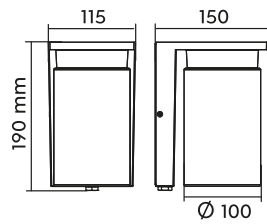

Sockelleuchte · Podestal lamp  
 excl. 1 x E27  
 max. 40 W  
 511660132

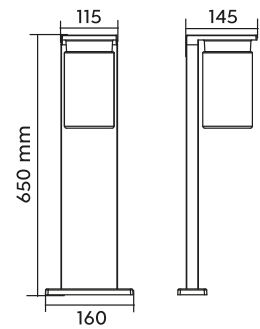

Bodenleuchte · Floor lamp  
 excl. 1 x E27  
 max. 40 W  
 411660132

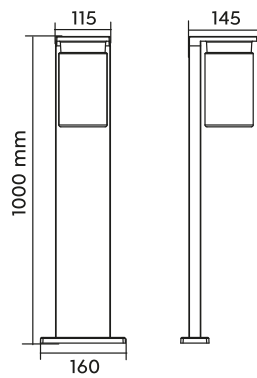

● Dämmerungssensor  
 per Schalter deaktivierbar ·  
 On and off switchable  
 dusk sensor





# ARDILA

Aluminium Druckguss, Glas · Diecast aluminium, glass ·  
 Fonte d'aluminium, verre · Gegoten aluminium, glas ·  
 Aluminio fundido, vidrio · Pressofusione di alluminio, vetro ·  
 Fonta aluminiu, sticla · Valualumiini, lasi · Barwione aluminium, szkło

 **35** | Holznachbildung · wood imitation

Empfohlen:  
recommended:

Filament LED  
E27, 4 W  
470 lm, 2.700 K



**987-400**



Wandleuchte · Wall lamp  
 excl. 1 x E27  
 max. 40 W  
**211660135**

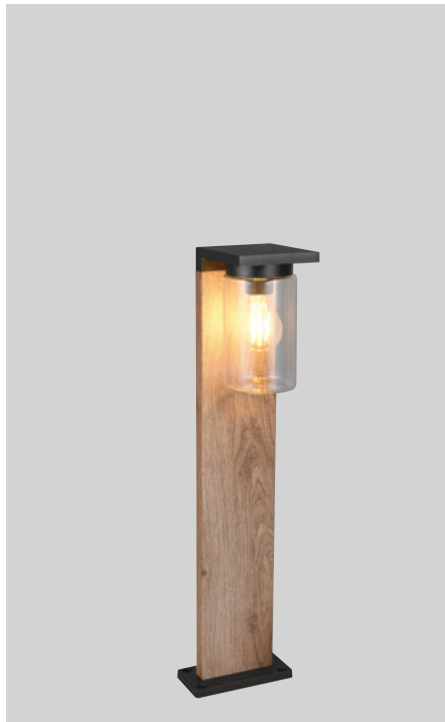
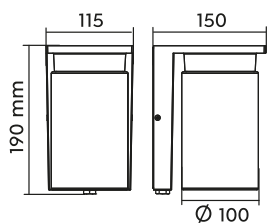

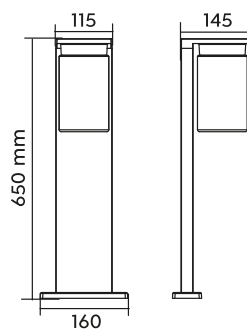

Sockelleuchte · Podestal lamp  
 excl. 1 x E27  
 max. 40 W  
**511660135**

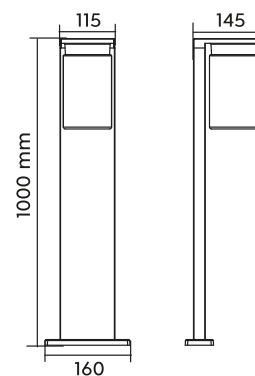

Bodenleuchte · Floor lamp  
 excl. 1 x E27  
 max. 40 W  
**411660135**



 Dämmerungssensor  
per Schalter deaktivierbar ·  
 On and off switchable  
dusk sensor



# COOPER

Edelstahl, Kunststoff · Steel, plastic ·

Acier, plastique · Staal, kunststof · Acero, plástico ·

Acciaio, plastica · Inox, plastic · Teräs, muovi · Stal, plastik

42 | Anthrazit · anthracite

Empfohlen:  
recommended:

Filament LED  
E27, 4 W  
470 lm, 2.700 K



987-400



Wandleuchte · Wall lamp

excl. 1 x E27  
max. 40 W

207360142

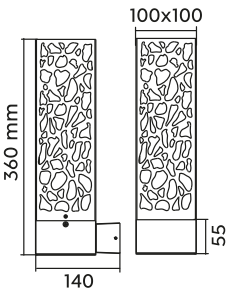

Sockelleuchte · Podestal lamp

excl. 1 x E27  
max. 40 W

507360142

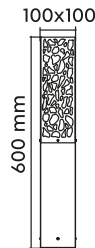

Bodenleuchte · Floor lamp

excl. 1 x E27  
max. 40 W

407360142

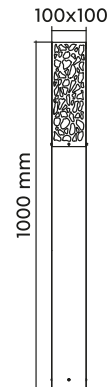



# FRASER

Aluminium Druckguss · Diecast aluminium ·  
 Fonte d'aluminium · Gegoten aluminium · Aluminio fundido  
 Pressofusione di alluminio · Fonta aluminu · Valualumiini · Barwione aluminium



Bewegungssensor ·  
 Motion sensor

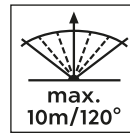

Wandleuchte · Wall lamp  
 excl. 1 x E27  
 max. 10 W  
**262569178**

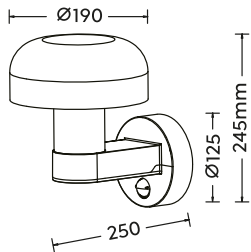

Wandleuchte · Wall lamp  
 excl. 1 x E27  
 max. 10 W  
**262560178**

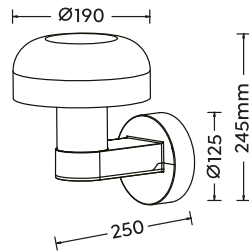

Sockelleuchte · Pedestal lamp  
 excl. 1 x E27  
 max. 10 W  
**562560178**

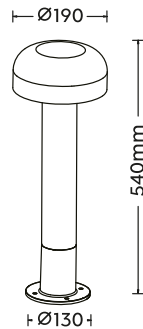

Bodenleuchte · Floor lamp  
 excl. 1 x E27  
 max. 10 W  
**462560178**

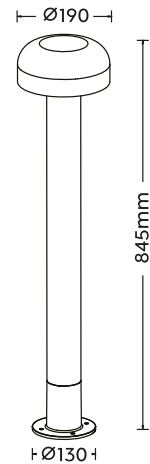



# FRASER

Aluminium Druckguss · Diecast aluminium ·  
 Fonte d'aluminium · Gegoten aluminium · Aluminio fundido  
 Pressofusione di alluminio · Fonta aluminu · Valualumiini · Barwione aluminium



Bewegungssensor ·  
 Motion sensor

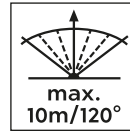

Wandleuchte · Wall lamp  
 excl. 1 x E27  
 max. 10 W  
**262569135**

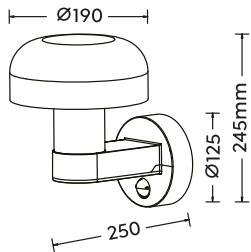

Wandleuchte · Wall lamp  
 excl. 1 x E27  
 max. 10 W  
**262560135**

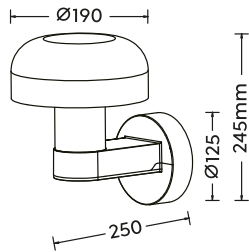

Sockelleuchte · Pedestal lamp  
 excl. 1 x E27  
 max. 10 W  
**562560135**

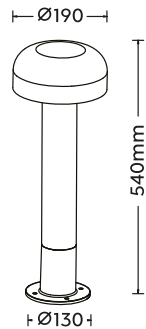

Bodenleuchte · Floor lamp  
 excl. 1 x E27  
 max. 10 W  
**462560135**

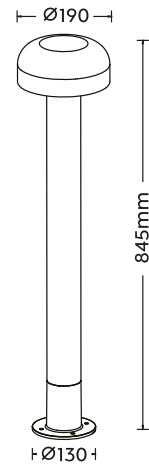



# MURES

Aluminium Druckguss, Glas · Diecast aluminium, glass ·  
 Fonte d'aluminium, verre · Gegoten aluminium, glas ·  
 Aluminio fundido, vidrio · Pressofusione di alluminio, vetro ·  
 Fonta aluminiu, sticla · Valualumiini, lasi · Barwione aluminium, szkło



Bewegungssensor ·  
 Motion sensor

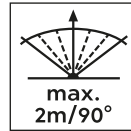

42 | Anthrazit · anthracite



Wandleuchte · Wall lamp  
 excl. 1 x E27  
 max. 40 W  
**269860142**

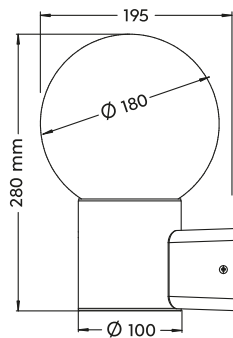

Wandleuchte · Wall lamp  
 excl. 1 x E27  
 max. 40 W  
**269869142**

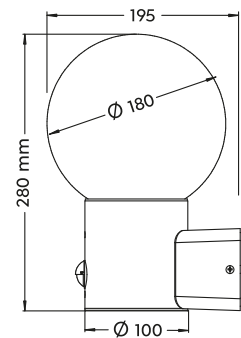

Sockelleuchte · Pedestal lamp  
 excl. 1 x E27  
 max. 40 W  
**569860142**

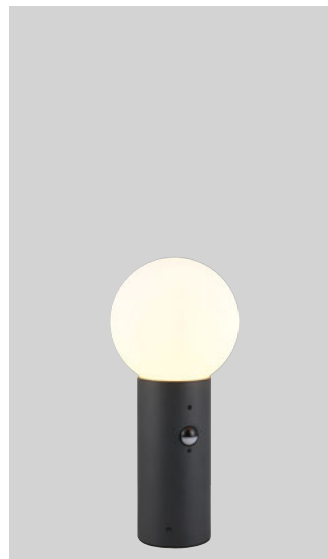
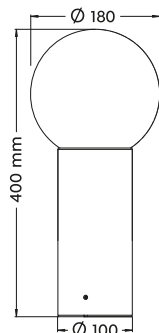

Sockelleuchte · Pedestal lamp  
 excl. 1 x E27  
 max. 40 W  
**569869142**

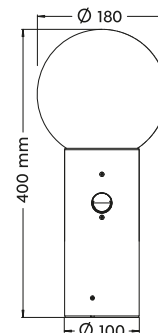

Bodenleuchte · Floor lamp  
 excl. 1 x E27  
 max. 40 W  
**469860142**



Bodenleuchte · Floor lamp  
 excl. 1 x E27  
 max. 40 W  
**469869142**





# HOOSIC

Aluminium Druckguss, Kunststoff · Diecast aluminium, plastic ·  
 Fonte d'aluminium, plastique · Gegoten aluminium, kunststof ·  
 Aluminio fundido, plástico · Pressofusione di alluminio, plastica ·  
 Fonta aluminiu, plastic · Valualumiini, muovi ·  
 Barwione aluminium, plastik

42 | Anthrazit · anthracite

Empfohlen:  
 recommended:

LED E27, 4,9 W  
 470 lm, 3.000 K



987-60



Wandleuchte · Wall lamp  
 excl. 1 x E27  
 max. 28 W  
**222260142**

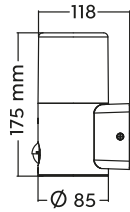

Wandleuchte · Wall lamp  
 excl. 2 x E27  
 max. 28 W  
**222260242**

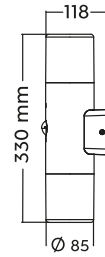

Sockelleuchte · Podestal lamp  
 excl. 1 x E27  
 max. 28 W  
**522260142**

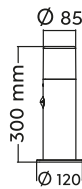

Bodenleuchte · Floor lamp  
 excl. 1 x E27  
 max. 28 W  
**422260142**





# HOOSIC

Aluminium Druckguss, Kunststoff · Diecast aluminium, plastic ·  
 Fonte d'aluminium, plastique · Gegoten aluminium, kunststof ·  
 Aluminio fundido, plástico · Pressofusione di alluminio, plastica ·  
 Fonta aluminiu, plastic · Valualumiini, muovi · Barwione aluminium, plastik

● 42 | Anthrazit · anthracite

Empfohlen:  
recommended:

LED E27, 4,9 W  
470 lm, 3.000 K



987-60



Wandleuchte · Wall lamp  
 excl. 1 x E27  
 max. 28 W  
**224060142**

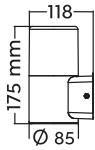

Wandleuchte · Wall lamp  
 excl. 2 x E27  
 max. 28 W  
**224060242**

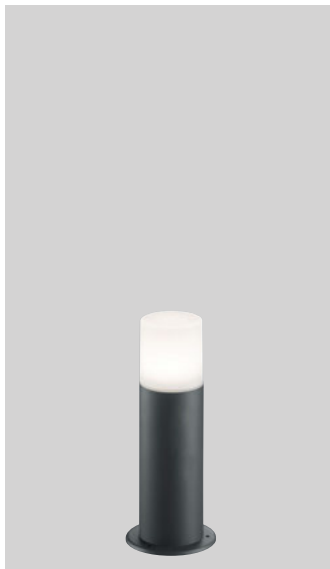
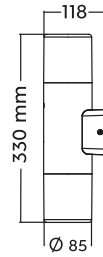

Wandleuchte · Wall lamp  
 excl. 1 x E27  
 max. 28 W  
**524060142**

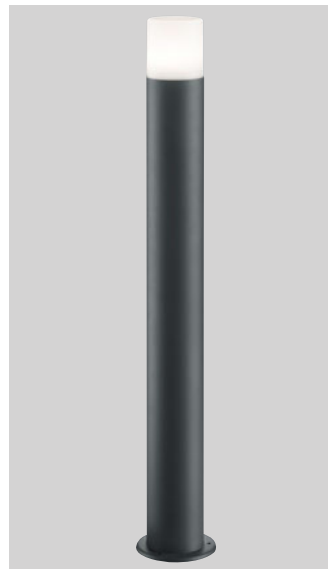
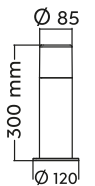

Wandleuchte · Wall lamp  
 excl. 1 x E27  
 max. 28 W  
**424060142**

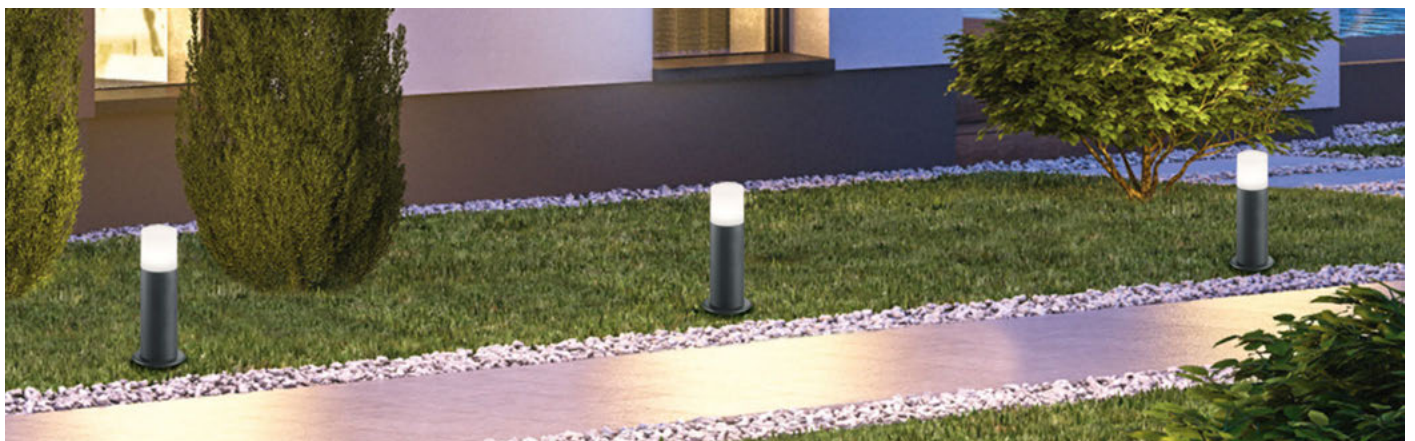
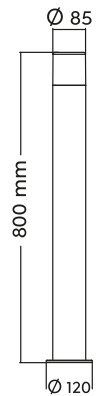

# HOOSIC

Aluminium Druckguss, Kunststoff · Diecast aluminium, plastic ·  
Fonte d'aluminium, plastique · Gegoten aluminium, kunststof ·  
Aluminio fundido, plástico · Pressofusione di alluminio, plastica ·  
Fonta aluminiu, plastic · Valualumiini, muovi · Barwione aluminium, plastik

● 42 | Anthrazit · anthracite



Bodenleuchte · Floor lamp

excl. 1 x E27

max. 28 W

424067142

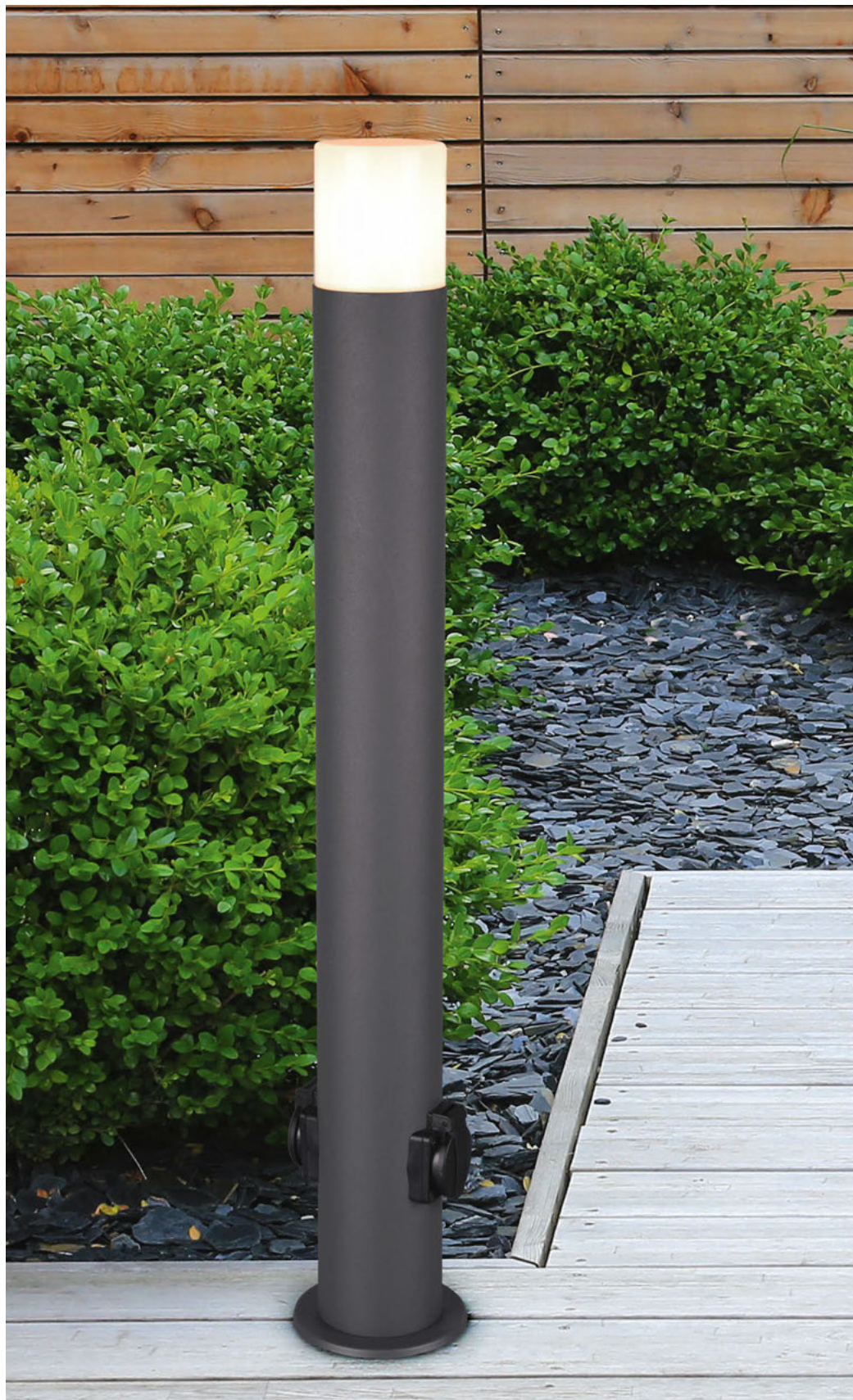

# HOOSIC

Aluminium Druckguss, Kunststoff · Diecast aluminium, plastic ·  
 Fonte d'aluminium, plastique · Gegoten aluminium, kunststof ·  
 Aluminio fundido, plástico · Pressofusione di alluminio, plastica ·  
 Fonta aluminiu, plastic · Valualumiini, muovi · Barwione aluminium, plastik

 **24** | rostfarbig · rusty

Empfohlen:  
recommended:

LED E27, 4,9 W  
470 lm, 3.000 K



**987-60**



Wandleuchte · Wall lamp  
excl. 1 x E27  
max. 28 W  
**222260124**

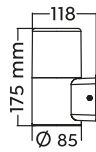

Wandleuchte · Wall lamp  
excl. 2 x E27  
max. 28 W  
**222260224**

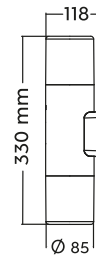

Sockelleuchte · Podestal lamp  
excl. 1 x E27  
max. 28 W  
**522260124**



Bodenleuchte · Floor lamp  
excl. 1 x E27  
max. 28 W  
**422260124**

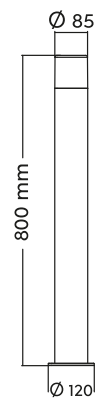



# HOOSIC

Aluminium Druckguss, Kunststoff · Diecast aluminium, plastic ·  
 Fonte d'aluminium, plastique · Gegoten aluminium, kunststof ·  
 Aluminio fundido, plástico · Pressofusione di alluminio, plastica ·  
 Fonta aluminiu, plastic · Valualumiini, muovi · Barwione aluminium, plastik

● 32 | Schwarz matt · black mat

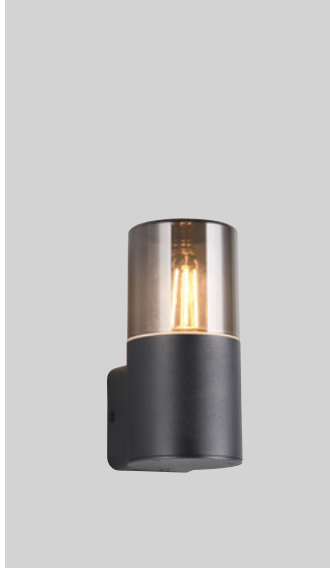

Wandleuchte · Wall lamp  
 excl. 1 x E27  
 max. 28 W  
 224060132

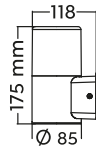

Wandleuchte · Wall lamp  
 excl. 2 x E27  
 max. 28 W  
 224060232

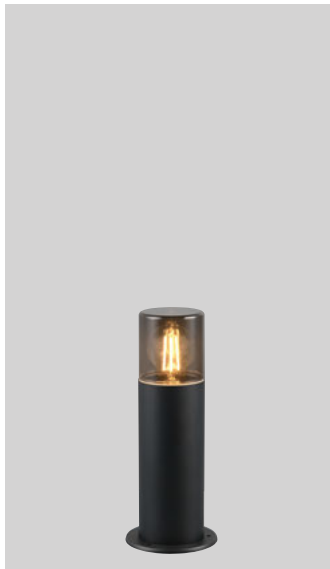
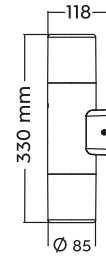

Sockelleuchte · Pedestal lamp  
 excl. 1 x E27  
 max. 28 W  
 524060132



Bodenleuchte · Floor lamp  
 excl. 2 x E27  
 max. 28 W  
 424060132



# HOOSIC

Aluminium Druckguss, Kunststoff · Diecast aluminium, plastic ·  
 Fonte d'aluminium, plastique · Gegoten aluminium, kunststof ·  
 Aluminio fundido, plástico · Pressofusione di alluminio, plastica ·  
 Fonta aluminiu, plastic · Valualumiini, muovii · Barwione aluminium, plastik



Bewegungssensor ·  
 Motion sensor

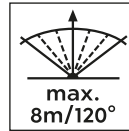

**32** | Schwarz matt · black mat



Wandleuchte · Wall lamp  
 excl. 1 x E27  
 max. 28 W  
**222260132**

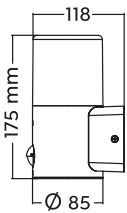

Wandleuchte · Wall lamp  
 excl. 2 x E27  
 max. 28 W  
**222260232**

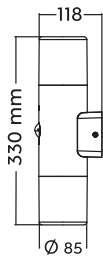

# HUDSON

Aluminium Druckguss, Kunststoff · Diecast aluminium, plastic ·  
Fonte d'aluminium, plastique · Gegoten aluminium, kunststof ·  
Aluminio fundido, plástico · Pressofusione di alluminio, plastica ·  
Fonta aluminii, plastic · Valualumiini, muovii · Barwione aluminium, plastik

Incl.:

LED E14, 3,5 W  
320 lm, 3.000 K



42 | Anthrazit · anthracite



Sockelleuchte · Pedestal lamp

incl. LED E14  
3,5 W / 320 Lumen  
3.000 Kelvin  
5200601**42**



Bodenleuchte · Floor lamp

incl. LED E14  
3,5 W / 320 Lumen  
3.000 Kelvin  
4200601**42**

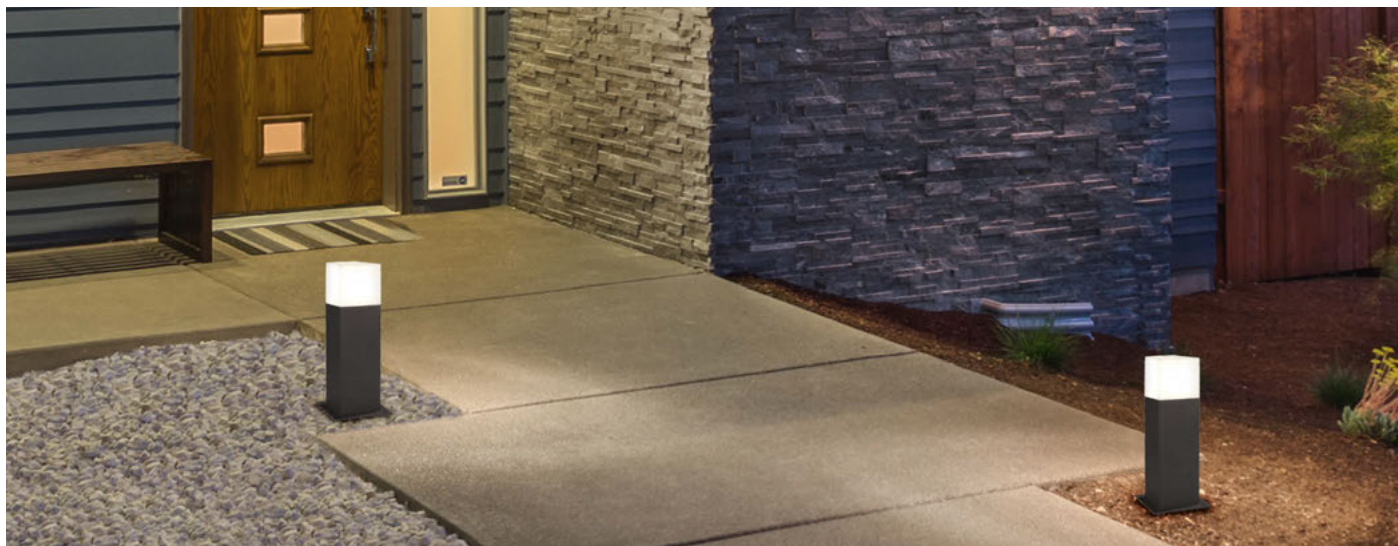



# CAVADO

Aluminium Druckguss, Kunststoff · Diecast aluminium, plastic ·  
 Fonte d'aluminium, plastique · Gegoten aluminium, kunststof ·  
 Aluminio fundido, plástico · Pressofusione di alluminio, plastica ·  
 Fonta aluminiu, plastic · Valualumiini, muovii · Barwione aluminium, plastik

● 42 | Anthrazit · anthracite



Bewegungssensor ·  
 Motion sensor

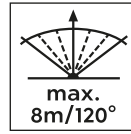

Empfohlen:  
 recommended:

Filament LED  
 E27, 4 W  
 470 lm, 2.700 K



987-400



Wandleuchte · Wall lamp  
 excl. 1 x E27  
 max. 40 W  
 211060142



Wandleuchte · Wall lamp  
 excl. 1 x E27  
 max. 40 W  
 211069142



Bodenleuchte · Floor lamp  
 excl. 1 x E27  
 max. 40 W  
 411060142

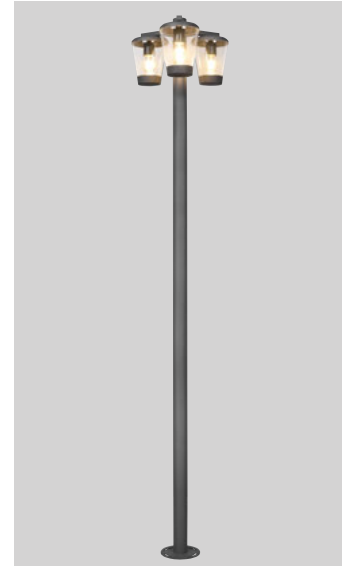

Bodenleuchte · Floor lamp  
 excl. 3 x E27  
 max. 40 W  
 411060342

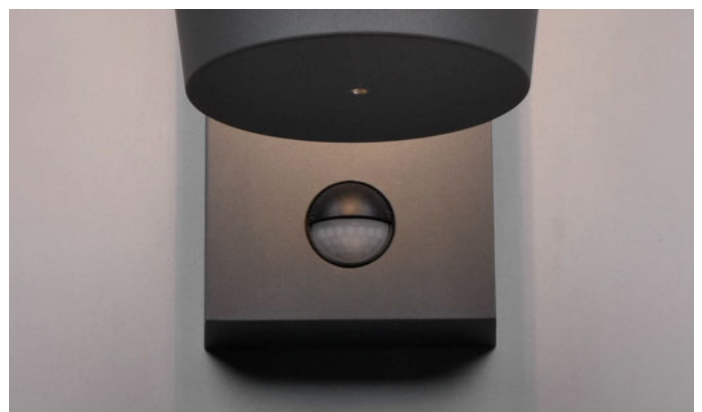
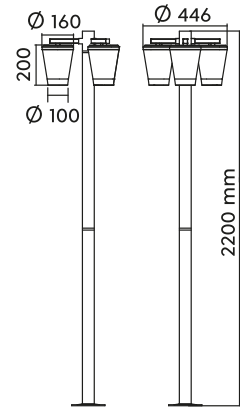
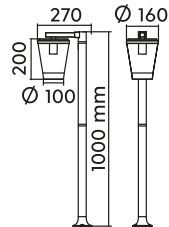
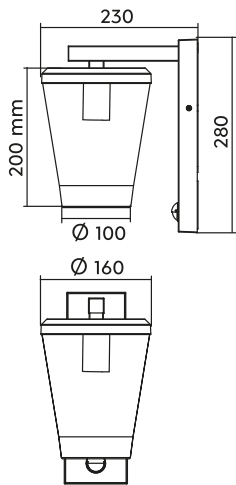
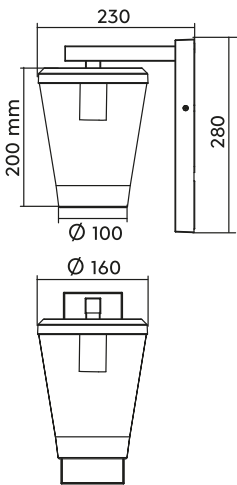



# SAMBESI

Aluminium Druckguss, Acryl · Diecast aluminium, acryl ·  
 Fonte d'aluminium, acryl · Gegoten aluminium, acryl ·  
 Aluminio fundido, acrílico · Pressofusione di alluminio, acrilico ·  
 Fonta aluminiu, acrilic · Valualumiini, akryyli · Barwione aluminium, akryl

42 | Anthrazit · anthracite

Empfohlen:  
 recommended:

Filament LED  
 E27, 4 W  
 470 lm, 2.700 K



987-400



Wandleuchte · Wall lamp

excl. 1 x E27  
 max. 28 W

204160142

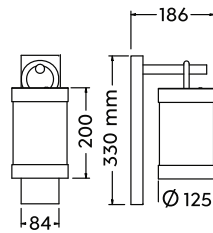

Sockelleuchte · Podestal lamp

excl. 1 x E27  
 max. 28 W

504160142

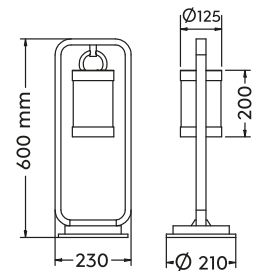

Bodenleuchte · Floor lamp

excl. 1 x E27  
 max. 28 W

404160142

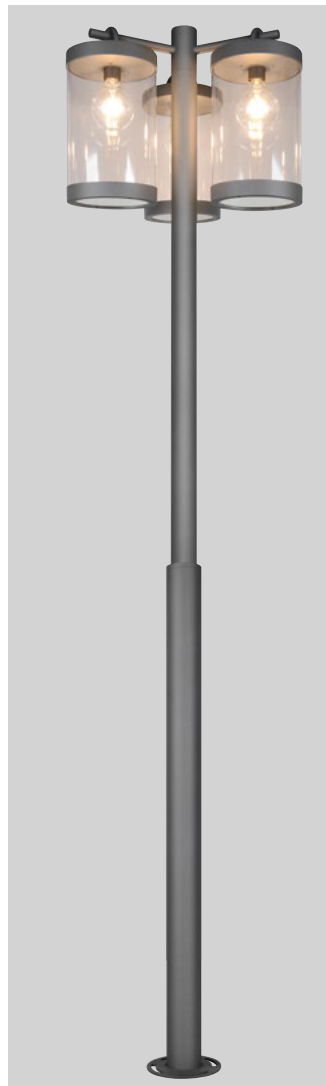
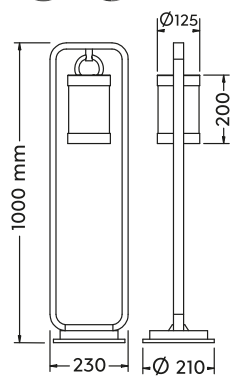



Bodenleuchte · Floor lamp

excl. 3 x E27  
 max. 28 W

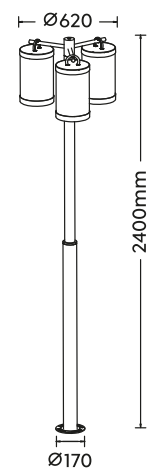
404160342



 Dämmerungssensor  
 per Schalter deaktivierbar ·  
 On and off switchable  
 dusk sensor



Wandleuchte · Wall lamp  
 excl. 1 x E27  
 max. 28 W  
**204169142**

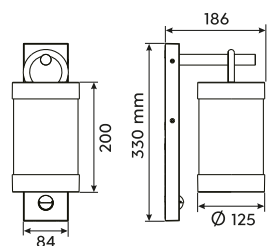

 Bewegungssensor ·  
 Motion sensor

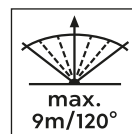

# SAMBESI

Aluminium Druckguss, Acryl · Diecast aluminium, acryl ·  
 Fonte d'aluminium, acryl · Gegoten aluminium, acryl ·  
 Aluminio fundido, acrílico · Pressofusione di alluminio, acrilico ·  
 Fonta aluminiu, acrilic · Valualumiini, akryyli · Barwione aluminium, akryl

● 24 | rostfarbig · rusty

Empfohlen:  
 recommended:

Filament LED  
 E27, 4 W  
 470 lm, 2.700 K



987-400



Wandleuchte · Wall lamp

excl. 1 x E27  
 max. 28 W

204160124

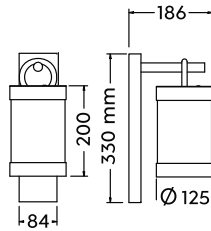

Sockelleuchte · Podestal lamp

excl. 1 x E27  
 max. 28 W

504160124

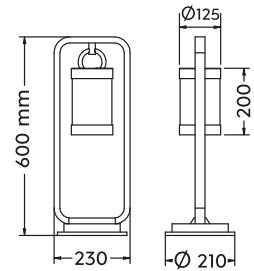

Bodenleuchte · Floor lamp

excl. 1 x E27  
 max. 28 W

404160124

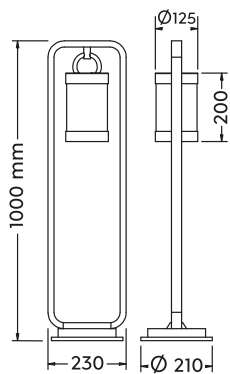

Bodenleuchte · Floor lamp

excl. 3 x E27  
 max. 28 W

404160324

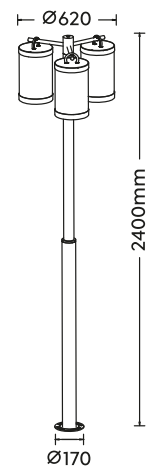

● Dämmerungssensor  
 per Schalter deaktivierbar ·  
 On and off switchable  
 dusk sensor



Wandleuchte · Wall lamp

excl. 1 x E27

max. 28 W

204169124



IP44



Bewegungssensor ·

Motion sensor

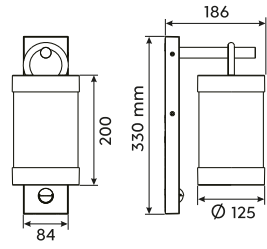
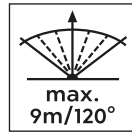

# SAMBESI

Aluminium Druckguss, Acryl · Diecast aluminium, acryl ·  
 Fonte d'aluminium, acryl · Gegoten aluminium, acryl ·  
 Aluminio fundido, acrílico · Pressofusione di alluminio, acrilico ·  
 Fonta aluminiu, acrilic · Valualumiini, akryyli · Barwione aluminium, akryl

 **31** | Weiß matt · white mat

 **35** | Holznachbildung · wood imitation

 Bewegungssensor ·  
 Motion sensor

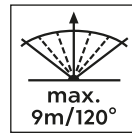

Empfohlen:  
 recommended:

Filament LED  
 E27, 4 W  
 470 lm, 2.700 K





**987-400**

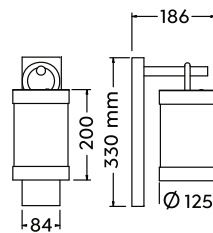

Wandleuchte · Wall lamp

excl. 1 x E27  
 max. 28 W  
**204160131**  
**204160135**



 Dämmerungssensor  
 per Schalter deaktivierbar ·  
 On and off switchable  
 dusk sensor



Wandleuchte · Wall lamp

excl. 1 x E27  
 max. 28 W  
**204169131**  
**204169135**

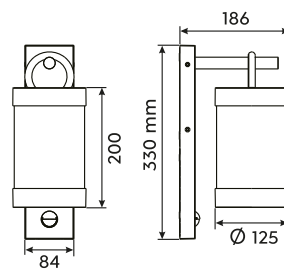

# GARONNE

Aluminium Druckguss, Glas · Diecast aluminium, glass ·  
 Fonte d'aluminium, verre · Gegoten aluminium, glas ·  
 Aluminio fundido, vidrio · Pressofusione di alluminio, vetro ·  
 Fonta aluminiu, sticla · Valualumiini, lasi · Barwione aluminium, szkło



Bewegungssensor ·  
 Motion sensor

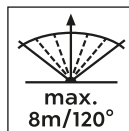

42 | Anthrazit · anthracite



Wandleuchte · Wall lamp  
 excl. 1 x E27  
 max. 60 W  
 201869142

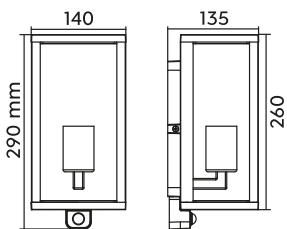

Bodenleuchte · Floor lamp  
 excl. 1 x E27  
 max. 60 W  
 401869142

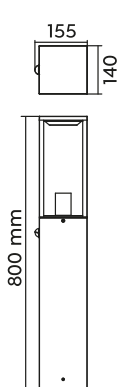

# GARONNE

Aluminium Druckguss, Glas · Diecast aluminium, glass ·  
 Fonte d'aluminium, verre · Gegoten aluminium, glas ·  
 Aluminio fundido, vidrio · Pressofusione di alluminio, vetro ·  
 Fonta aluminiu, sticla · Valualumiini, lasi · Barwione aluminium, szkło

 **24** | rostfarbig · rusty

 **42** | Anthrazit · anthracite

 **31** | Weiß matt · white mat

Empfohlen:  
recommended:

Filament LED  
E27, 4 W  
470 lm, 2.700 K



**987-400**



Wandleuchte · Wall lamp

excl. 1 x E27  
max. 60 W

**201860124**  
**201860131**  
**201860142**

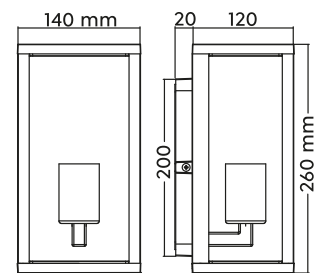

Wandleuchte · Wall lamp

excl. 2 x E27  
max. 10 W

**201860224**  
**201860231**  
**201860242**

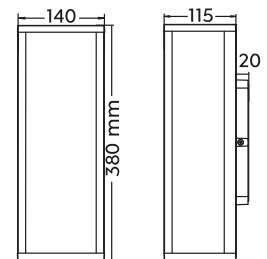

Deckenleuchte · Ceiling lamp

excl. 2 x E27  
max. 10 W

**601860242**

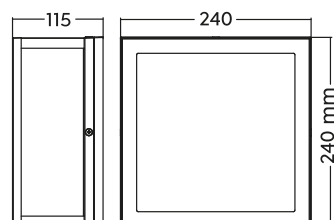

Sockelleuchte · Podestal lamp

excl. 1 x E27  
max. 60 W

501860142



140 x 140

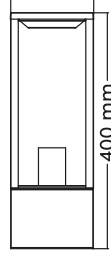

400 mm

Bodenleuchte · Floor lamp

excl. 1 x E27  
max. 60 W

401860142



140 x 140

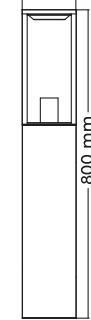

800 mm



Metall, Glas · Metal, glass ·  
 Metale, verre · Metaal, glas · Metal, vidrio ·  
 Metallo, vetro · Metal, sticla · Metalli, lasi · Metal, szkło

86 | zinkfarbig · zinc-colored



Wandleuchte · Wall lamp  
 excl. 1 x E27  
 max. 10 W  
**262060186**

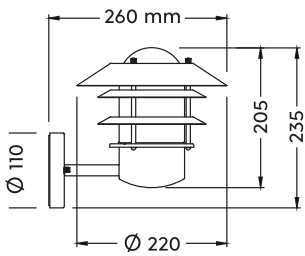

Wandleuchte · Wall lamp  
 excl. 1 x E27  
 max. 10 W  
**262067186**

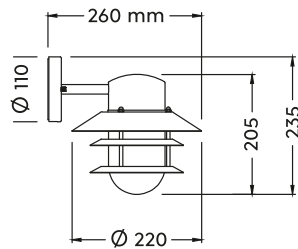

Sockelleuchte · Podestal lamp  
 excl. 1 x E27  
 max. 10 W  
**562060186**

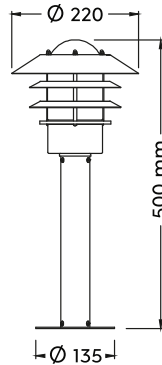

Bodenleuchte · Floor lamp  
 excl. 1 x E27  
 max. 10 W  
**462060186**





# BARITO



Metall zinkfarbig, Glas · Metal zinc-colored, glass ·  
 Metale couleur zinc, verre · Metaal zink kleur, glas · Metal color zinc, vidrio ·  
 Metallo color zinco, vetro · Metal culoarea zincului, sticla · Metalli antiikkiihopea, lasi ·  
 Metal kolor cynkowy, szkło

86 | zinkfarbig · zinc-colored



Wandleuchte · Wall lamp  
 excl. 2 x E27  
 max. 15 W  
**260660286**

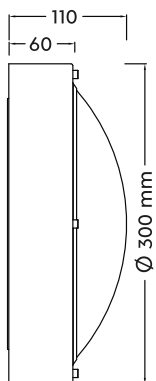

# TUMEN



Metall zinkfarbig, Kunststoff · Metal zinc-colored, plastic ·  
 Metale couleur zinc, plastique · Metaal zink kleur, kunststof · Metal color zinc, plástico ·  
 Metallo color zinco, plastica · Metal culoarea zincului, plastic · Metalli antiikkiihopea, muovi ·  
 Metal kolor cynkowy, plastik

86 | zinkfarbig · zinc-colored



Wandleuchte · Wall lamp  
 excl. 1 x E27  
 max. 10 W  
**260560186**

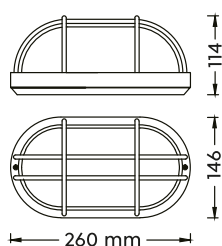

Metall zinkfarbig, Glas · Metal zinc-colored, glass ·  
 Metale couleur zinc, verre · Metaal zink kleur, glas · Metal color zinc, vidrio ·  
 Metallo color zinco, vetro · Metal culoarea zincului, sticla · Metalli antiikkihopea, lasi ·  
 Metal kolor cynkowy, szkło

 **86** | zinkfarbig · zinc-colored

Empfohlen:  
recommended:

Filament LED  
E27, 4 W  
470 lm, 2.700 K



**987-400**



Wandleuchte · Wall lamp  
 excl. 1 x E27  
 max. 20 W  
**261060186**

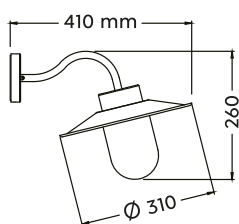

# NORMAN

Aluminium Druckguss, Acryl · Diecast aluminium, acryl ·  
 Fonte d'aluminium, acryl · Gegoten aluminium, acryl ·  
 Aluminio fundido, acrílico · Pressofusione di alluminio, acrilico ·  
 Fonta aluminiu, acrilic · Valualumiini, akryyli · Barwione aluminium, akryl

● 24 | rostfarbig · rusty



Bewegungssensor ·  
 Motion sensor

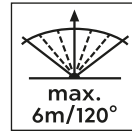

Empfohlen:  
 recommended:

LED E27, 4,9 W  
 470 lm, 3.000 K



987-60



Wandleuchte · Wall lamp  
 excl. 1 x E27  
 max. 40 W  
 207269124

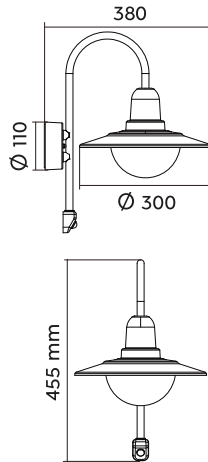

# BRENTA

Aluminium Druckguss, Glas · Diecast aluminium, glass ·  
 Fonte d'aluminium, verre · Gegoten aluminium, glas · Aluminio fundido, vidrio · Pressofusione di alluminio, vetro ·  
 Fonta aluminiu, sticla · Valualumiini, lasi · Barwione aluminium, szkło

● 24 | rostfarbig · rusty

● 42 | Anthrazit · anthracite

○ 31 | Weiß matt · white mat

Empfohlen:  
 recommended:

Filament LED  
 E27, 4 W  
 470 lm, 2.700 K



987-400



Wandleuchte · Wall lamp  
 excl. 1 x E27  
 max. 40 W  
 201760124  
 201760131  
 201760142

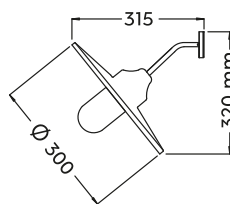

# ATRATO



Aluminium · Aluminium ·  
Aluminium · Aluminium · Aluminio ·  
Alluminio · Aluminu · Alumiini · Aluminium

 **24** | rostfarbig · rusty

 **42** | Anthrazit · anthracite

Empfohlen:  
recommended:

LED GX53, 10 W  
950 lm, 4.000 K



**953-1334**



42

Wandleuchte · Wall lamp

excl. 1 x GX53  
max. 10 W

**218260124**

**218260142**



IP44

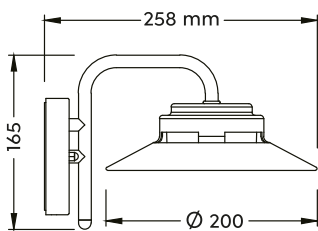

24

# VOLTURNO

Aluminium Druckguss, Glas · Diecast aluminium, glass ·  
 Fonte d'aluminium, verre · Gegoten aluminium, glas ·  
 Aluminio fundido, vidrio · Pressofusione di alluminio, vetro ·  
 Fonta aluminiu, sticla · Valualumiini, lasi · Barwione aluminium, szkło

**28** | rostfarbig antik · antique rust

Empfohlen:  
 recommended:

Filament LED  
 E27, 4 W  
 470 lm, 2.700 K



**987-400**



Wandleuchte · Wall lamp  
 excl. 1 x E27  
 max. 60 W  
**205960128**

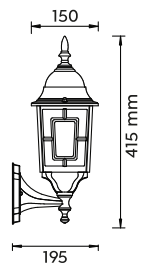

Wandleuchte · Wall lamp  
 excl. 1 x E27  
 max. 60 W  
**205967128**

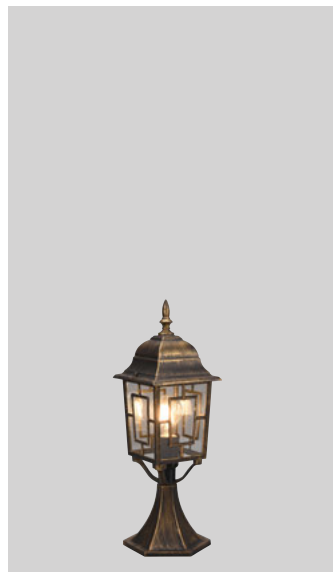
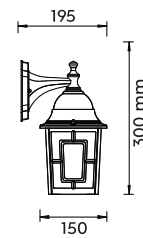

Sockelleuchte · Podestal lamp  
 excl. 1 x E27  
 max. 60 W  
**505960128**

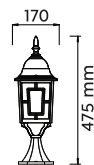

Bodenleuchte · Floor lamp  
 excl. 1 x E27  
 max. 60 W  
**405960128**

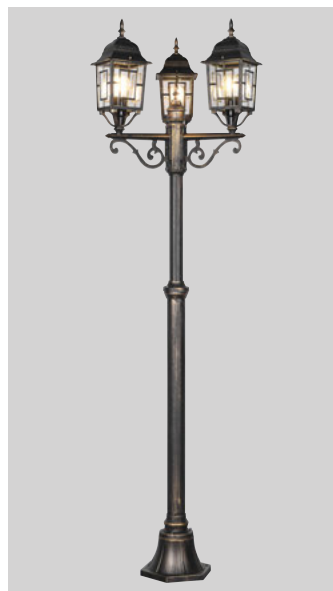
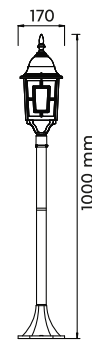

Bodenleuchte · Floor lamp  
 excl. 3 x E27  
 max. 60 W  
**405960328**

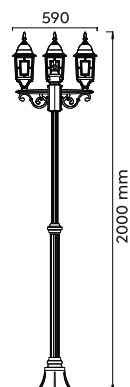



# ELVO

Aluminium Druckguss, Glas · Diecast aluminium, glass ·  
 Fonte d'aluminium, verre · Gegoten aluminium, glas ·  
 Aluminio fundido, vidrio · Pressofusione di alluminio, vetro ·  
 Fonta aluminiu, sticla · Valualumiini, lasi · Barwione aluminium, szkło

● 32 | Schwarz matt · black mat

Empfohlen:  
 recommended:

Filament LED  
 E27, 4 W  
 470 lm, 2.700 K



987-400



Wandleuchte · Wall lamp  
 excl. 1 x E27  
 max. 60 W  
 206960132

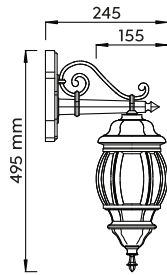

Wandleuchte · Wall lamp  
 excl. 1 x E27  
 max. 60 W  
 206967132

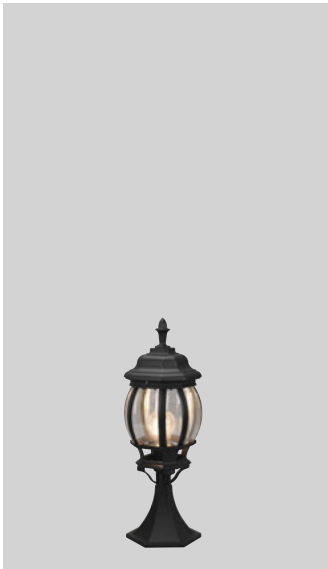
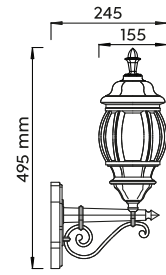

Sockelleuchte · Podestal lamp  
 excl. 1 x E27  
 max. 60 W  
 506960132



Bodenleuchte · Floor lamp  
 excl. 1 x E27  
 max. 60 W  
 406960132

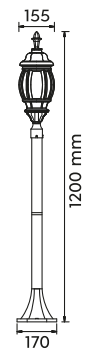

Bodenleuchte · Floor lamp  
 excl. 3 x E27  
 max. 60 W  
 406960332

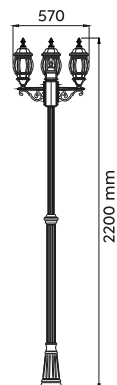



# LIVENZA

Aluminium Druckguss, Glas · Diecast aluminium, glass ·  
 Fonte d'aluminium, verre · Gegoten aluminium, glas ·  
 Aluminio fundido, vidrio · Pressofusione di alluminio, vetro ·  
 Fonta aluminiu, sticla · Valualumiini, lasi · Barwione aluminium, szkło

○ 31 | Weiß matt · white mat

● 32 | Schwarz matt · black mat

Empfohlen:  
 recommended:

Filament LED  
 E27, 4 W  
 470 lm, 2.700 K



987-400



Wandleuchte · Wall lamp  
 excl. 1 x E27  
 max. 60 W  
 205760131  
 205760132

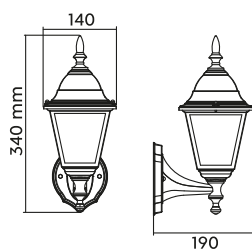

32



Wandleuchte · Wall lamp  
 excl. 1 x E27  
 max. 60 W  
 205767131  
 205767132

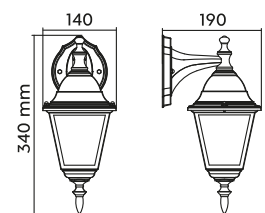

31



Sockelleuchte · Pedestal lamp  
 excl. 1 x E27  
 max. 60 W  
 505760131  
 505760132

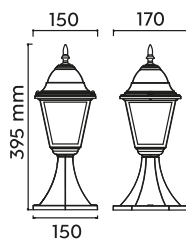

31

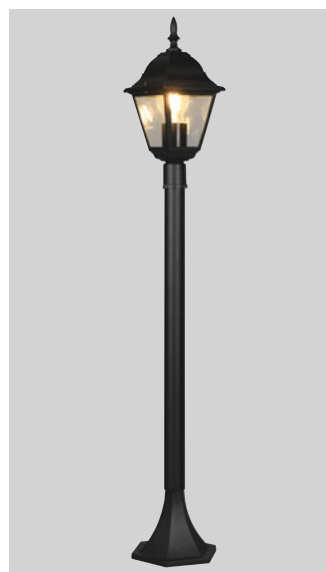

Bodenleuchte · Floor lamp  
 excl. 1 x E27  
 max. 60 W  
 405760132

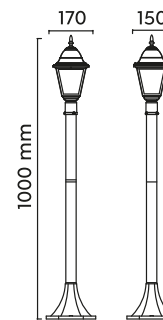

Bodenleuchte · Floor lamp  
 excl. 3 x E27  
 max. 60 W  
 405760332

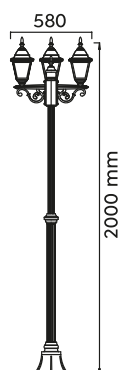



# VENTA

Aluminium Druckguss, Kunststoff · Diecast aluminium, plastic ·  
 Fonte d'aluminium, plastique · Gegoten aluminium, kunststof ·  
 Aluminio fundido, plástico · Pressofusione di alluminio, plastica ·  
 Fonta aluminiu, plastic · Valualumiini, muovu · Barwione aluminium, plastik

○ 31 | Weiß matt · white mat

● 32 | Schwarz matt · black mat

Empfohlen:  
 recommended:

Filament LED  
 E27, 4 W  
 470 lm, 2.700 K



987-400



Wandleuchte · Wall lamp  
 excl. 1 x E27  
 max. 10 W  
 263260131  
 263260132

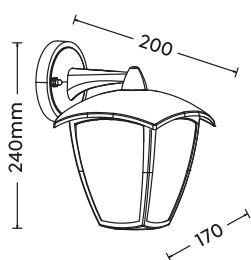

32



Wandleuchte · Wall lamp  
 excl. 1 x E27  
 max. 10 W  
 263260231  
 263260232

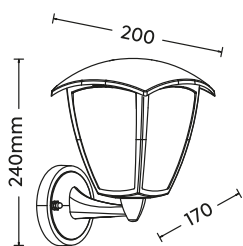

32



Sockelleuchte · Pedestal lamp  
 excl. 1 x E27  
 max. 10 W  
 563260131  
 563260132

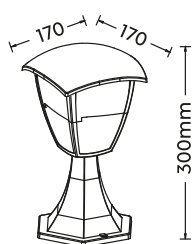

31



# VENTA

Aluminium Druckguss, Kunststoff · Diecast aluminium, plastic ·  
 Fonte d'aluminium, plastique · Gegoten aluminium, kunststof ·  
 Aluminio fundido, plástico · Pressofusione di alluminio, plastica ·  
 Fonta aluminiu, plastic · Valualumiini, muovi · Barwione aluminium, plastik



**31** | Weiß matt · white mat



**32** | Schwarz matt · black mat

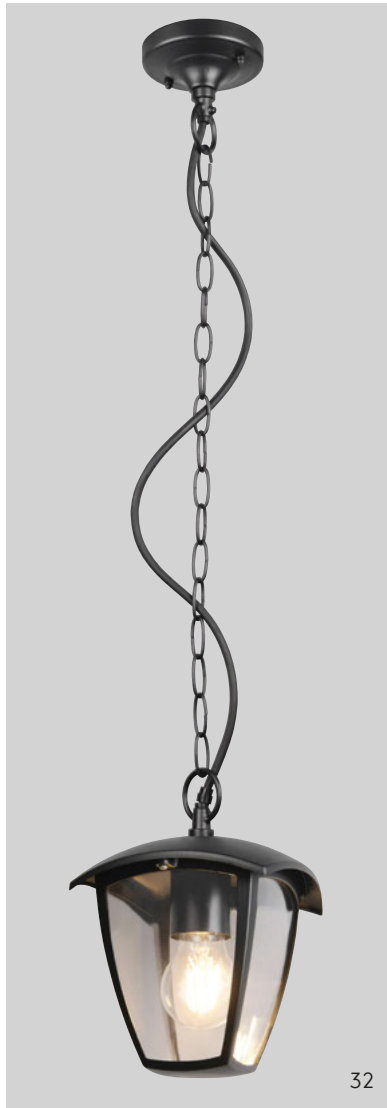

Pendelleuchte · Pendant

excl. 1 x E27

max. 10 W

**363260131**

**363260132**

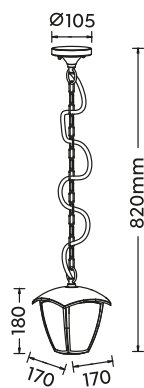

32



Wandleuchte · Wall lamp

excl. 1 x E27

max. 10 W

**263260331**

**263260332**

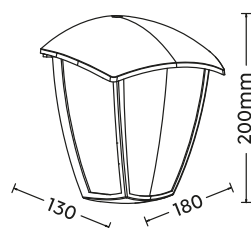

31



# OLONA

Aluminium Druckguss, Glas · Diecast aluminium, glass ·  
Fonte d'aluminium, verre · Gegoten aluminium, glas ·  
Aluminio fundido, vidrio · Pressofusione di alluminio, vetro ·  
Fonta aluminiu, sticla · Valualumiini, lasi · Barwione aluminium, szkło

● 24 | rostfarbig · rusty

● 42 | Anthrazit · anthracite

Empfohlen:  
recommended:

Filament LED  
E27, 4 W  
470 lm, 2.700 K



987-400



24



42

Wandleuchte · Wall lamp

excl. 1 x E27  
max. 40 W

201960124

201960142

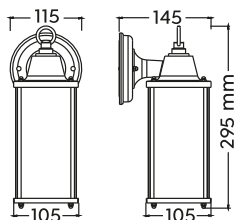

# TANARO

Aluminium Druckguss, Acryl · Diecast aluminium, acryl ·  
Fonte d'aluminium, acryl · Gegoten aluminium, acryl ·  
Aluminio fundido, acrílico · Pressofusione di alluminio, acrilico ·  
Fonta aluminiu, acrilic · Valualumiini, akryyli · Barwione aluminium, akryl

 **24** | rostfarbig · rusty

 **42** | Anthrazit · anthracite

Empfohlen:  
recommended:

Filament LED  
E27, 4 W  
470 lm, 2.700 K



**987-400**



24



42

Wandleuchte · Wall lamp

excl. 1 x E27  
max. 40 W

2023601**24**

2023601**42**

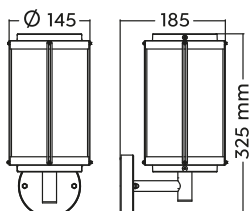

# DUERO

Aluminium Druckguss, Glas · Diecast aluminium, glass ·  
 Fonte d'aluminium, verre · Gegoten aluminium, glas ·  
 Aluminio fundido, vidrio · Pressofusione di alluminio, vetro ·  
 Fonta aluminiu, sticla · Valualumiini, lasi · Barwione aluminium, szkło

 **24** | rostfarbig · rusty

 **42** | Anthrazit · anthracite

Empfohlen:  
recommended:

Filament LED  
E27, 4 W  
470 lm, 2.700 K



**987-400**



Wandleuchte · Wall lamp

excl. 1 x E27  
max. 40 W

2027601**24**  
2027601**42**

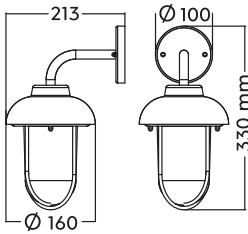

# LUNGA

Aluminium Druckguss, Glas · Diecast aluminium, glass ·  
 Fonte d'aluminium, verre · Gegoten aluminium, glas ·  
 Aluminio fundido, vidrio · Pressofusione di alluminio, vetro ·  
 Fonta aluminiu, sticla · Valualumiini, lasi · Barwione aluminium, szkło

 **42** | Anthrazit · anthracite



Dämmerungssensor per Schalter deaktivierbar ·  
On and off switchable dusk sensor

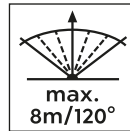

Wandleuchte · Wall lamp

excl. 1 x E27  
max. 40 W

2120601**42**

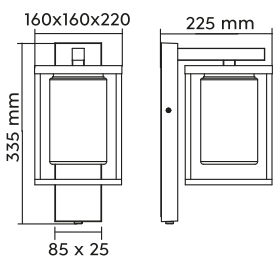

Wandleuchte · Wall lamp

excl. 1 x E27  
max. 40 W

2120691**42**

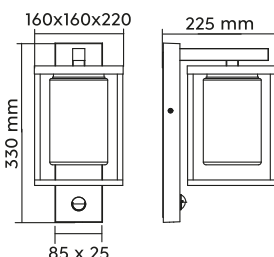

# MIRANDE

Aluminium Druckguss, Glas · Diecast aluminium, glass ·  
Fonte d'aluminium, verre · Gegoten aluminium, glas ·  
Aluminio fundido, vidrio · Pressofusione di alluminio, vetro ·  
Fonta aluminiu, sticla · Valualumiini, lasi · Barwione aluminium, szkło

 **24** | rostfarbig · rusty

 **42** | Anthrazit · anthracite

 **31** | Weiß matt · white mat

Empfohlen:  
recommended:

Filament LED  
E27, 4 W  
470 lm, 2.700 K



**987-400**



Wandleuchte · Wall lamp

excl. 1 x E27  
max. 40 W

**262260124**

**262260131**

**262260142**



 IP23

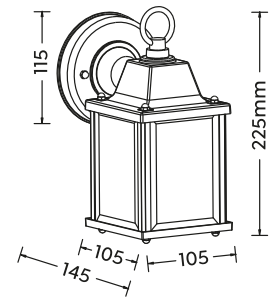

# BELAJA

Edelstahl · Steel ·  
Acier · Staal · Acero ·  
Acciaio · Inox · Teräs · Stal



Abstrahlwinkel ·  
Emission angle



Belastbarkeit ·  
Resilience

07 | Nickel matt · nickel mat



Einbauleuchte · Recessed spot  
incl. SMD-LED  
3,5 W / 350 Lumen  
3.000 Kelvin  
**821660107**

IP65

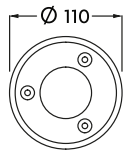
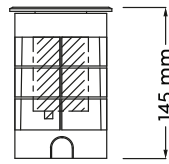

Einbauleuchte · Recessed spot  
incl. SMD-LED  
8 W / 900 Lumen  
3.000 Kelvin  
**821660207**

IP65

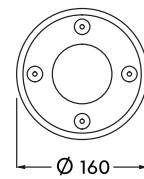
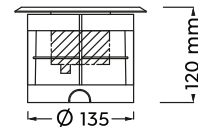

# UBANGI

Aluminium Druckguss · Diecast aluminium ·  
 Fonte d'aluminium · Gegoten aluminium · Aluminio fundido ·  
 Pressofusione di alluminio · Fonta aluminiu · Valualumiini · Barwione aluminium

● 42 | Anthrazit · anthracite

Empfohlen:  
 recommended:

LED GU10, 4,9 W  
 430 lm, 3.000 K  
 ≥ 110°



955-50



Strahler · Spot  
 excl. 1 x GU10  
 max. 10 W  
 800260142

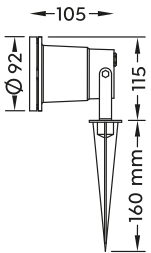

Strahler · Spot  
 excl. 3 x GU10  
 max. 10 W  
 800260342

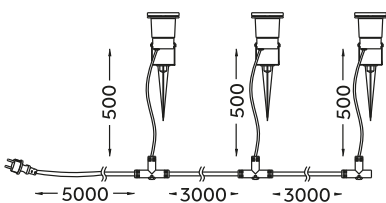

3er Set / Set 3



# GARTENSTECKDOSEN · GARDEN SOCKETS

Aluminium Druckguss · Diecast aluminium ·  
 Fonte d'aluminium · Gegoten aluminium · Aluminio fundido ·  
 Pressofusione di alluminio · Fonta aluminii · Valualumiini · Barwione aluminium

 4 x Steckdosen ·  
 4 x Plug

 42 | Anthrazit · anthracite



Gartensteckdose · Garden socket  
 max. 3.600 W  
 9964-42

   IP54

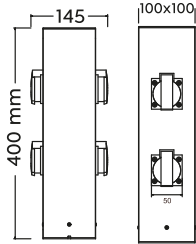

Polyresin · Polyresin ·  
 Polyresin · Polyresin · Poliresina ·  
 Poliestere · Polirasina · Polyresiini · Polyresin

 4 x Steckdosen ·  
 4 x Plug

 11 | Grau · grey



Gartensteckdose · Garden socket  
 max. 3.600 W  
 9962-11

    IP44

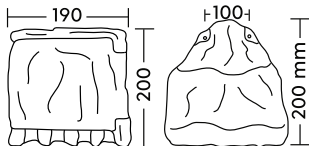

# UNIVERSAL-ERDSPIESS · GROUND SPIKE

Erdspieß, Edelstahl · Ground spike, steel ·

Piquet de terre, acier · Aardingspin, staal · Espiga, acero ·

Picchetto, acciaio · Țepușă pentru pământ, inox · Maapiikki, teräs · Žerdz, stal

07 | Nickel matt · nickel mat



9960-07

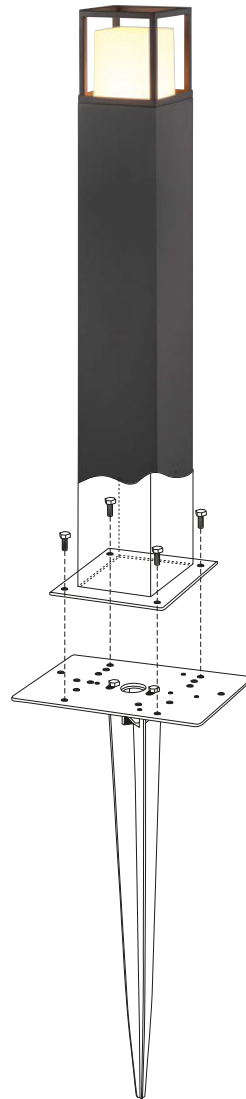
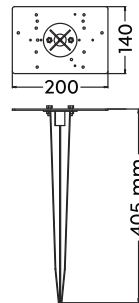

# ECKBEFESTIGUNG · CORNER FASTENING

Eckbefestigung, Kunststoff · Corner fastening, plastic ·

Montage en angle, plastique · Hoekbevestiging, kunststof · Cantonera, plástico ·

Montaggio ad angolo, plastica · Fixare pentru colț, plastic · Kulmakiinnike, muovi · Okucie narożne, plastik

32 | Schwarz matt · black mat

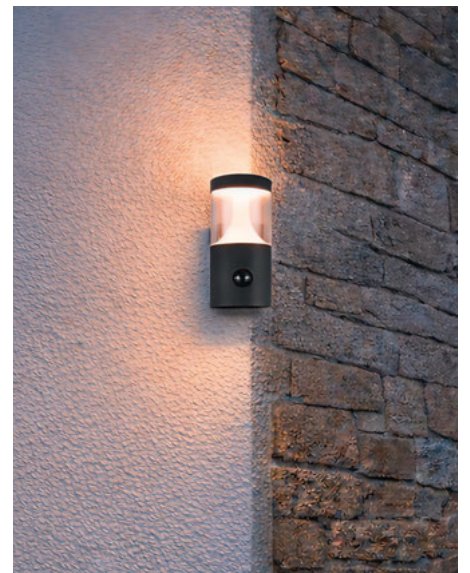
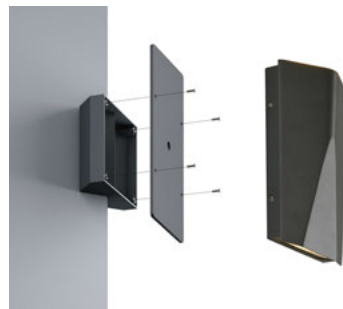

9965-32

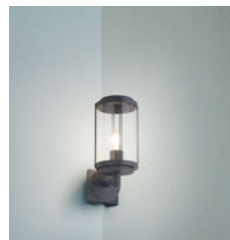
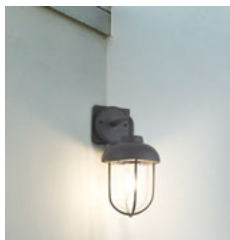
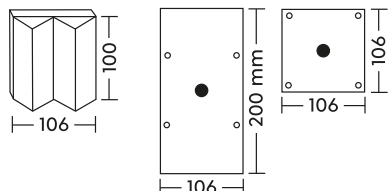





# BEJA

Aluminium Druckguss, Kunststoff · Diecast aluminium, plastic ·  
 Fonte d'aluminium, plastique · Gegoten aluminium, kunststof ·  
 Aluminio fundido, plástico · Pressofusione di alluminio, plastica ·  
 Fonta aluminiu, plastic · Valualumiini, muov · Barwione aluminium, plastik



Bewegungssensor ·  
 Motion sensor

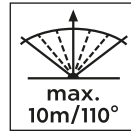

42 | Anthrazit · anthracite



Wandleuchte · Wall lamp  
 incl. SMD-LED  
 12,5 W / 1.650 Lumen  
 4.000 Kelvin  
**R23356142**

Wandleuchte · Wall lamp  
 incl. SMD-LED  
 12,5 W / 1.650 Lumen  
 4.000 Kelvin  
**R23359142**

Sockelleuchte · Pedestal lamp  
 incl. SMD-LED  
 12,5 W / 1.650 Lumen  
 4.000 Kelvin  
**R53356142**

Bodenleuchte · Floor lamp  
 incl. SMD-LED  
 12,5 W / 1.650 Lumen  
 4.000 Kelvin  
**R43356142**

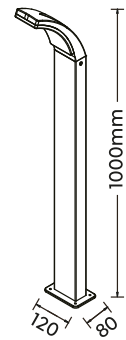
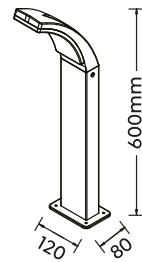
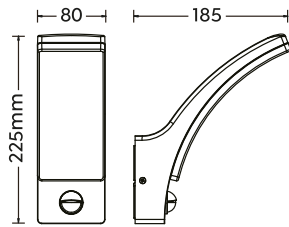
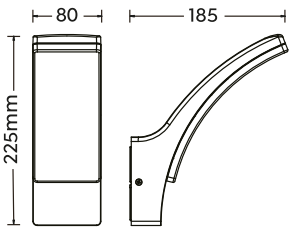



# BRAGA

Metall, Glas · Metal, glass ·

Metale, verre · Metaal, glas · Metal, vidrio ·

Metallo, vetro · Metal, sticla · Metalli, lasi · Metal, szkło

○ 31 | Weiß matt · white mat

● 32 | Schwarz matt · black mat

Empfohlen:  
recommended:

LED GU10, 4,5 W  
345 lm, 3.000 K  
 $\approx 36^\circ$



956-5936



Wandleuchte · Wall lamp

excl. 1 x GU10

max. 10 W

R26971631

R26971632

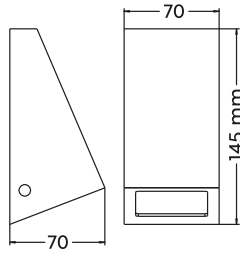

# CUSCO

Kunststoff · Plastic ·  
Plastique · Kunststoff · Plástico ·  
Plastica · Plastic · Muovi · Plastik



32 | Schwarz matt · black mat

**Incl.:**  
LED GX53, 10 W  
950 lm, 4.000 K



Wandleuchte · Wall lamp  
incl. LED GX53  
10 W / 950 Lumen  
4.000 Kelvin  
**R26961632**

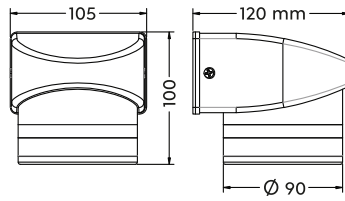

Wandleuchte · Wall lamp  
incl. 2 x LED GX53  
2 x 10 W / 2 x 950 Lumen  
4.000 Kelvin  
**R26962632**

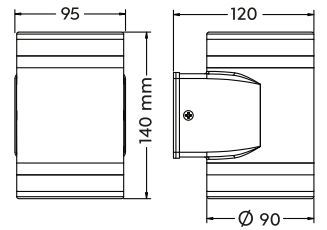

# CORDOBA

Kunststoff · Plastic ·

Plastique · Kunststof · Plástico ·

Plastica · Plastic · Muovi · Plastik



31 | Weiß matt · white mat



32 | Schwarz matt · black mat



Wandleuchte · Wall lamp

incl. 2 x SMD-LED

2 x 2 W / 2 x 200 Lumen

3.000 Kelvin

R282226**31**

R282226**32**



IP44

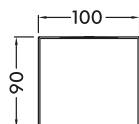
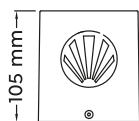

# ROSARIO

Kunststoff · Plastic ·  
Plastique · Kunststoff · Plástico ·  
Plastica · Plastic · Muovi · Plastik

○ 31 | Weiß matt · white mat

● 32 | Schwarz matt · black mat



Wandleuchte · Wall lamp  
incl. 2 x SMD-LED  
2 x 2 W / 2 x 200 Lumen  
3.000 Kelvin  
**R28232631**  
**R28232632**

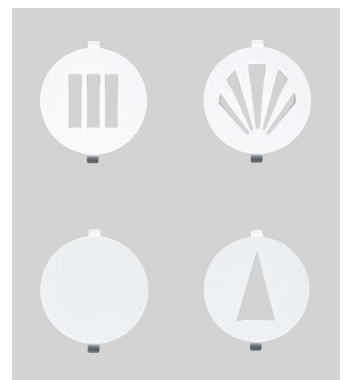
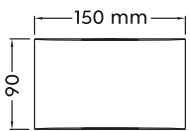
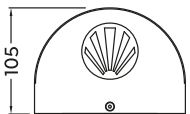

# MOLINA

Aluminium Druckguss, Kunststoff · Diecast aluminium, plastic ·

Fonte d'aluminium, plastique · Gegoten aluminium, kunststof · Aluminio fundido, plástico ·

Pressofusione di alluminio, plastica · Fonta aluminii, plastic · Valualumiini, muovii · Barwione aluminium, plastik

42 | Anthrazit · anthracite



Wandleuchte · Wall lamp  
incl. 2 x SMD-LED  
2 x 4,6 W / 2 x 550 Lumen  
3.000 Kelvin  
**R22052142**

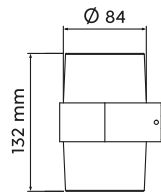
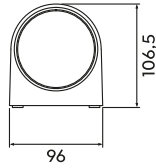

Wandleuchte · Wall lamp  
incl. 2 x SMD-LED  
2 x 4,6 W / 2 x 550 Lumen  
3.000 Kelvin  
**R22062142**

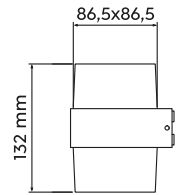
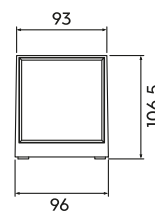

# PUNO

Kunststoff · Plastic ·  
Plastique · Kunststoff · Plástico ·  
Plastica · Plastic · Muovi · Plastik

● 32 | Schwarz matt · black mat



Wandleuchte · Wall lamp  
incl. SMD-LED  
8 W / 800 Lumen  
3.000 Kelvin  
**R27026132**

IP54

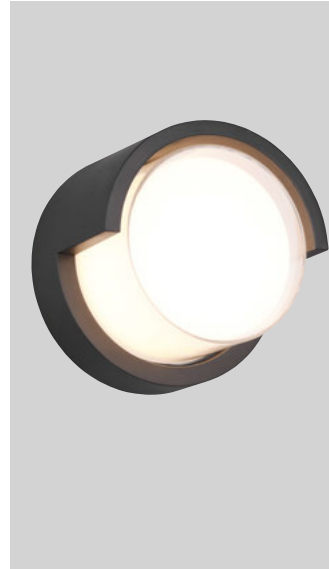
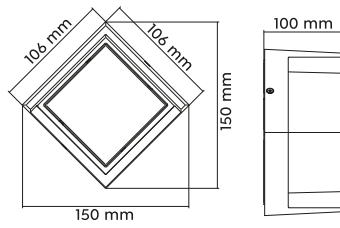

Wandleuchte · Wall lamp  
incl. SMD-LED  
8 W / 800 Lumen  
3.000 Kelvin  
**R27036132**

IP54

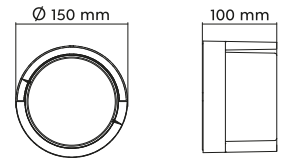

# FORTALEZA

Aluminium Druckguss, Kunststoff · Diecast aluminium, plastic ·  
 Fonte d'aluminium, plastique · Gegoten aluminium, kunststof ·  
 Aluminio fundido, plástico · Pressofusione di alluminio, plastica ·  
 Fonta aluminiu, plastic · Valualumiini, muov · Barwione aluminium, plastik

● 42 | Anthrazit · anthracite

 Bewegungssensor und Orientierungslicht ·  
 Motion sensor and orientation light

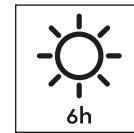
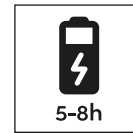
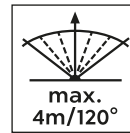

Wandleuchte · Wall lamp  
 incl. SMD-LED  
 2 W / 200 Lumen  
 3.000 Kelvin  
**R23056142**

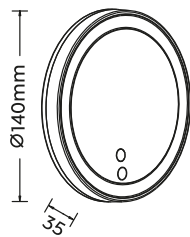

Wandleuchte · Wall lamp  
 incl. SMD-LED  
 2 W / 200 Lumen  
 3.000 Kelvin  
**R23056242**

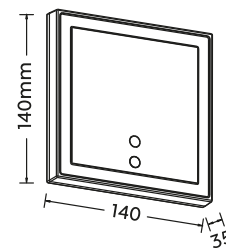

 **AKKUBETRIEB**  
 RECHARGEABLE



# AMBATO

Kunststoff · Plastic ·  
Plastique · Kunststoff · Plástico · Plastica · Plastic · Muovi · Plastik



Stoßfest gemäß IK10 ·  
Shock-resistant according to IK10

 **31** | Weiß matt · white mat

 **32** | Schwarz matt · black mat



Wandleuchte · Wall lamp  
excl. 1 x E27  
max. 10 W  
**R26931631**  
**R26931632**

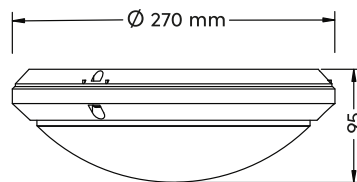

# BARCELOS

Aluminium Druckguss, Kunststoff · Diecast aluminium, plastic ·  
Fonte d'aluminium, plastique · Gegoten aluminium, kunststof ·  
Aluminio fundido, plástico · Pressofusione di alluminio, plastica ·  
Fonta aluminiu, plastic · Valualumiini, muovi · Barwione aluminium, plastik

 **32** | Schwarz matt · black mat



Wandleuchte · Wall lamp  
excl. 2 x GU10  
max. 10 W  
**R26446232**

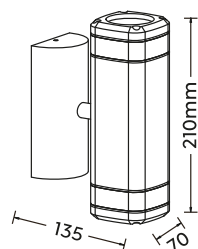

# FUNCHAL

Aluminium Druckguss, Glas · Diecast aluminium, glass ·  
 Fonte d'aluminium, verre · Gegoten aluminium, glas ·  
 Aluminio fundido, vidrio · Pressofusione di alluminio, vetro ·  
 Fonta aluminiu, sticla · Valualumiini, lasi · Barwione aluminium, szkło

● 32 | Schwarz matt · black mat

 Kippbar ·  
Tiltable

 Bewegungssensor ·  
Motion sensor

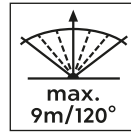

Wandleuchte · Wall lamp  
 incl. SMD-LED  
 20 W / 1.800 Lumen  
 4.000 Kelvin  
**R23346132**

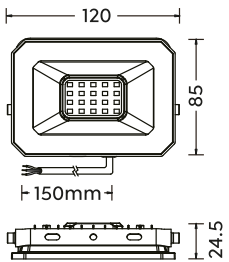

Wandleuchte · Wall lamp  
 incl. SMD-LED  
 30 W / 2.800 Lumen  
 4.000 Kelvin  
**R23346232**

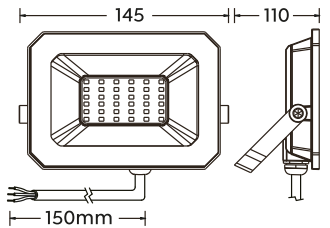

Wandleuchte · Wall lamp  
 incl. SMD-LED  
 20 W / 1.800 Lumen  
 4.000 Kelvin  
**R23349132**

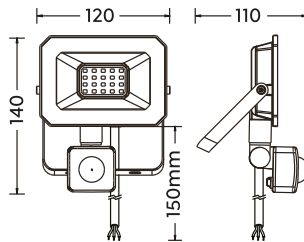

Wandleuchte · Wall lamp  
 incl. SMD-LED  
 30 W / 2800 Lumen  
 4.000 Kelvin  
**R23349232**

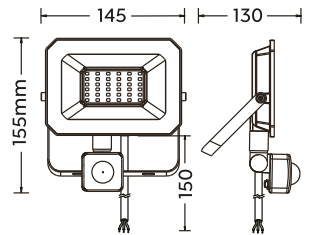



# PUELO

Aluminium Druckguss, Kunststoff · Diecast aluminium, plastic ·  
Fonte d'aluminium, plastique · Gegoten aluminium, kunststof ·  
Aluminio fundido, plástico · Pressofusione di alluminio, plastica ·  
Fonta aluminiu, plastic · Valualumiini, muovii · Barwione aluminium, plastik

○ 31 | Weiß matt · white mat

● 32 | Schwarz matt · black mat

Empfohlen:  
recommended:

LED E27, 4,9 W  
470 lm, 3.000 K



987-60



31



32

Wandleuchte · Wall lamp

excl. 1 x E27  
max. 10 W

R21186131

R21186132

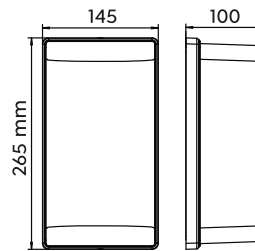

# SINTRA

Edelstahl, Glas · Steel, glass ·  
 Acier, verre · Staal, glas · Acero, vidrio ·  
 Acciaio, vetro · Inox, sticla · Teräs, lasi · Stal, szkło

● **32** | Schwarz matt · black mat

 Bewegungssensor ·  
 Motion sensor

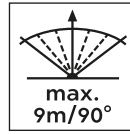

Empfohlen:  
 recommended:

LED E27, 4,9 W  
 470 lm, 3.000 K



**987-60**

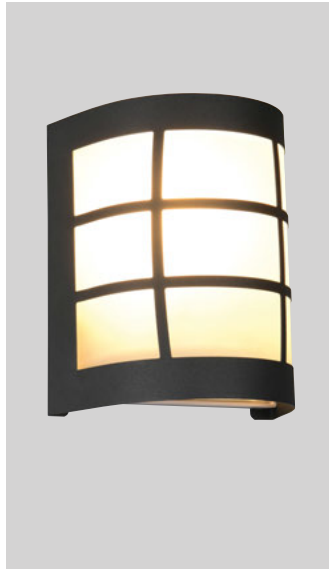

Wandleuchte · Wall lamp  
 excl. 1 x E27  
 max. 25 W  
**R26456132**

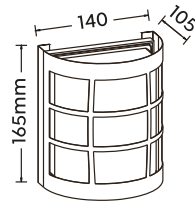

Wandleuchte · Wall lamp  
 excl. 1 x E27  
 max. 25 W  
**R26459132**

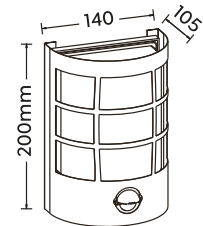

# KENDAL

Kunststoff · Plastic ·  
Plastique · Kunststof · Plástico ·  
Plastica · Plastic · Muovi · Plastik

● 42 | Anthrazit · anthracite



Wandleuchte · Wall lamp  
incl. SMD-LED  
12 W / 1.400 Lumen  
3.000 Kelvin  
**R22151142**

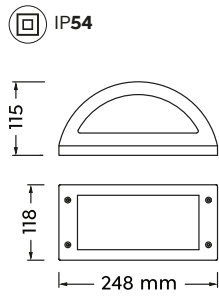

Deckenleuchte · Ceiling lamp  
incl. SMD-LED  
11 W / 1.180 Lumen  
3.000 Kelvin  
**R62151142**

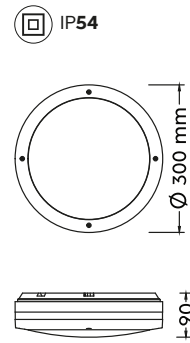

# CAMARO

Kunststoff · Plastic ·  
Plastique · Kunststof · Plástico ·  
Plastica · Plastic · Muovi · Plastik

○ 31 | Weiß matt · white mat

● 42 | Anthrazit · anthracite

Empfohlen:  
recommended:

LED E27, 4,9 W  
470 lm, 3.000 K



**986-60**

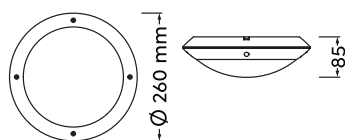

Deckenleuchte · Ceiling lamp  
excl. 1 x E27  
max. 12 W  
**R60501031**  
**R60501042**

● IP54





# BONITO

Aluminium Druckguss, Kunststoff · Diecast aluminium, plastic ·  
Fonte d'aluminium, plastique · Gegoten aluminium, kunststof ·  
Aluminio fundido, plástico · Pressofusione di alluminio, plastica ·  
Fonta aluminiu, plastic · Valualumiini, muovi · Barwione aluminium, plastik

 **24** | rostfarbig · rusty

 **32** | Schwarz matt · black mat

 **31** | Weiß matt · white mat

Empfohlen:  
recommended:

Filament LED  
E27, 4 W  
470 lm, 2.700 K



**987-400**



Wandleuchte · Wall lamp

excl. 1 x E27  
max. 28 W

**R21596124**

**R21596131**

**R21596132**



 IP44

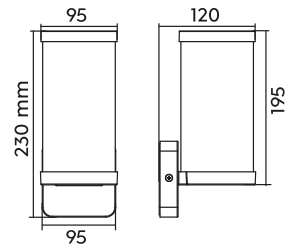

# ALMERIA

Aluminium Druckguss, Kunststoff · Diecast aluminium, plastic ·  
Fonte d'aluminium, plastique · Gegoten aluminium, kunststof ·  
Aluminio fundido, plástico · Pressofusione di alluminio, plastica ·  
Fonta aluminiu, plastic · Valualumiini, muovii · Barwione aluminium, plastik

 **24** | rostfarbig · rusty

 **42** | Anthrazit · anthracite

Empfohlen:  
recommended:

Filament LED  
E27, 4 W  
470 lm, 2.700 K



**987-400**



24



42

Wandleuchte · Wall lamp

excl. 1 x E27  
max. 28 W

R264761**24**

R264761**42**

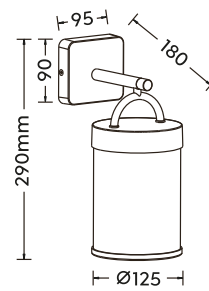

# SCOOP

Edelstahl · Steel ·  
Acier · Staal · Acero ·  
Acciaio · Inox · Teräs · Stal

32 | Schwarz matt · black mat

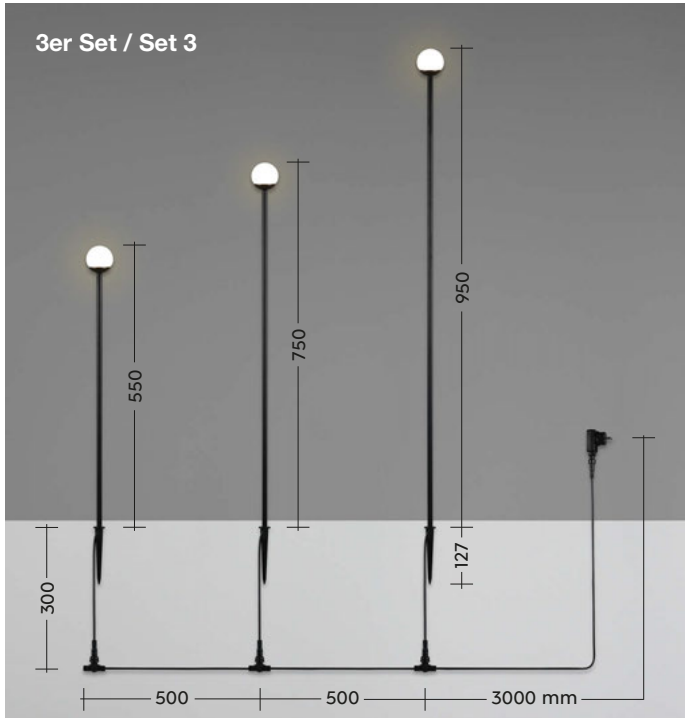

Gartenleuchte · Garden lamp  
incl. 3 x LED  
3 x 1,5 W / 3 x 160 Lumen  
3.000 Kelvin  
**R45863632**

IP44



In der Höhe anpassbar (55 / 75 / 95 cm)  
Height adjustable (55 / 75 / 95 cm)

# STICK

Edelstahl · Steel ·  
Acier · Staal · Acero ·  
Acciaio · Inox · Teräs · Stal

32 | Schwarz matt · black mat

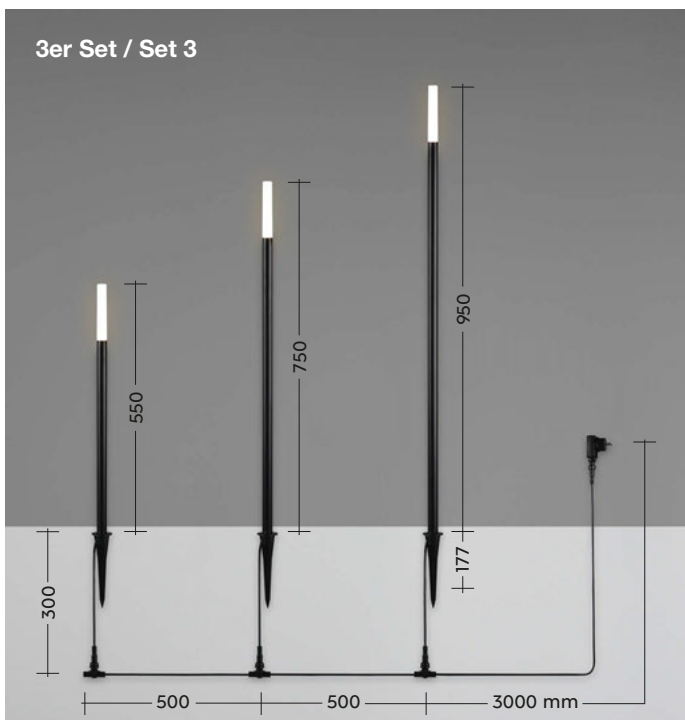

Gartenleuchte · Garden lamp  
incl. 3 x LED  
3 x 3,5 W / 3 x 330 Lumen  
3.000 Kelvin  
**R45853632**

IP44



In der Höhe anpassbar (55 / 75 / 95 cm)  
Height adjustable (55 / 75 / 95 cm)



# BOLO

Kunststoff · Plastic ·  
Plastique · Kunststoff · Plástico ·  
Plastica · Plastic · Muovi · Plastik

01 | Weiß · white

Empfohlen:  
recommended:

LED E27, 4,9 W  
470 lm, 3.000 K



987-60



Bodenleuchte · Floor lamp  
excl. 1 x E27  
max. 23 W  
R57042001

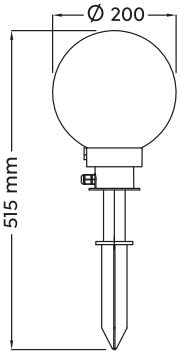

Bodenleuchte · Floor lamp  
excl. 1 x E27  
max. 23 W  
R57043001

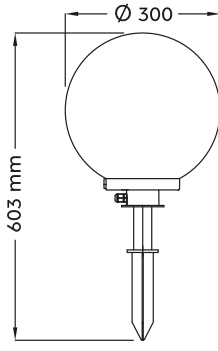

Bodenleuchte · Floor lamp  
excl. 1 x E27  
max. 23 W  
R57044001

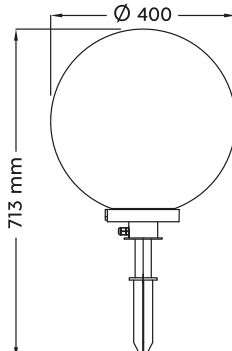

# CACERES

Kunststoff · Plastic ·  
Plastique · Kunststoff · Plástico ·  
Plastica · Plastic · Muovi · Plastik

02 | Schwarz · black



Kippbar ·  
Tilttable

Incl.:

LED E27, 15 W  
1.500 lm, 4.000 K



Strahler · Spot  
incl. LED E27  
15 W / 1.500 Lumen  
4.000 Kelvin  
R86466102

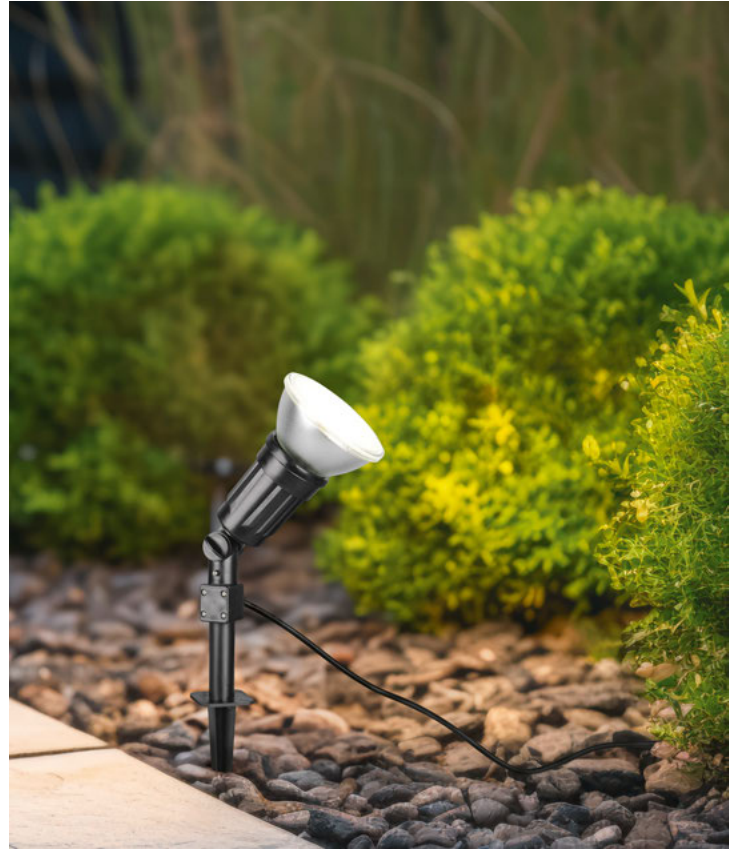
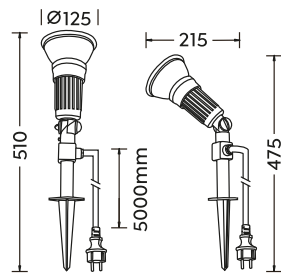

# PURUS



Aluminium Druckguss · Diecast aluminium ·  
Fonte d'aluminium · Gegoten aluminium · Aluminio fundido ·  
Pressofusione di alluminio · Fonta aluminu · Valualumiini · Barwione aluminium

42 | Anthrazit · anthracite

Empfohlen:  
recommended:

LED Mini-GU10  
4 W, 345 lm  
2.700 K



954-1432



Strahler · Spot  
excl. 1 x GU10  
max. 5 W  
R86871042

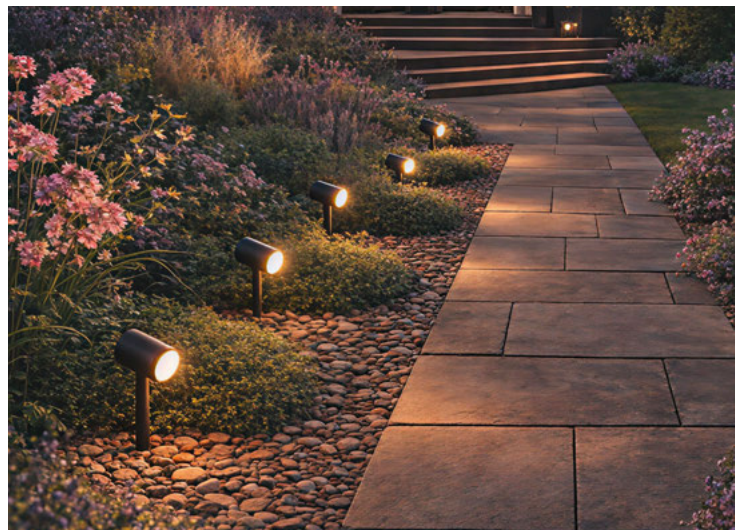
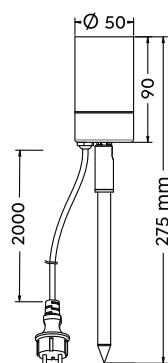

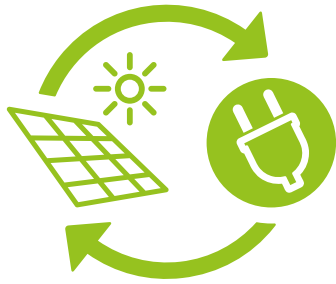

GB

Hybrid solar lights charge up with solar energy during the day and provide bright light at night. On cloudy days, when the sun is not shining and the solar charge is running low, the light automatically connects to the power grid to continue working at full capacity.

NL

Hybride solarlampen laden overdag op met zonne-energie en geven 's nachts helder licht. Op bewolkte dagen, als de zon niet schijnt en de zonnelading laag is, maakt de lamp automatisch verbinding met het elektriciteitsnet om op volle capaciteit te blijven werken.

IT

Le lampade solari ibride si ricaricano con l'energia solare durante il giorno e forniscono una luce brillante di notte. Nelle giornate nuvolose, quando il sole non splende e la carica solare è bassa, la lampada si collega automaticamente alla rete elettrica per continuare a funzionare a pieno regime.

FI

Hybridiaurinkolamput latautuvat aurinkoenergialla päivällä ja antavat loistavaa valoa yöllä. Pilvisenä päivänä, kun aurinko ei paista ja aurinkolataus on vähissä, lamppu kytkeytyy automaattisesti verkkoon jatkaakseen toimintaansa täydellä teholla.

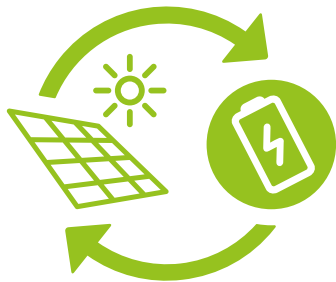

GB

If the solar charge is low, the light can be easily recharged in just a few hours using the built-in USB function. This guarantees constant light output and maximum efficiency.

NL

Als de zonne-energie bijna leeg is, kan de lamp eenvoudig in een paar uur worden opgeladen met de ingebouwde USB-functie. Dit garandeert een constante lichtopbrengst en maximale efficiëntie.

IT

Se la carica solare è bassa, la luce può essere facilmente ricaricata in poche ore utilizzando la funzione USB integrata. Questo garantisce un'emissione luminosa costante e la massima efficienza.

FI

Jos aurinkolataus on vähissä, valo voidaan ladata helposti muutamassa tunnissa sisäänrakennetun USB-toiminnon avulla. Tämä takaa tasaisen valotehon ja maksimaalisen tehokkuuden.

D

Hybride Solarleuchten tanken tagsüber Sonnenenergie und sorgen nachts für helles Licht. An trüben Tagen, wenn die Sonne mal nicht scheint und die Solarladung zur Neige geht, verbindet sich die Leuchte automatisch mit dem Stromnetz, um mit voller Kapazität weiterzuarbeiten.

FR

Les lampes solaires hybrides se rechargent à l'énergie solaire pendant la journée et fournissent une lumière brillante la nuit. Par temps nuageux, lorsque le soleil ne brille pas et que la charge solaire est faible, la lampe se connecte automatiquement au réseau électrique pour continuer à fonctionner à pleine capacité.

ES

Las lámparas solares híbridas se recargan con energía solar durante el día y proporcionan una luz brillante por la noche. En los días nublados, cuando el sol no brilla y la carga solar es baja, la lámpara se conecta automáticamente a la red para seguir funcionando a pleno rendimiento.

RO

Lămpile solare hibride se reîncarcă cu energie solară în timpul zilei și oferă lumină strălucitoare noaptea. În zilele înnorate, când soarele nu strălucește și încărcarea solară este scăzută, lampa se conectează automat la rețea pentru a continua să funcționeze la capacitate maximă.

PL

Hybrydowe lampy solarne ładują się energią słoneczną w ciągu dnia i zapewniają doskonałe światło w nocy. W pochmurne dni, gdy słońce nie świeci, a poziom naładowania jest niski, lampa automatycznie łączy się z siecią, aby kontynuować pracę z pełną wydajnością.

D

Bei schwacher Solarladung lässt sich die Leuchte in wenigen Stunden über die eingebaute USB-Funktion mühelos aufladen. Das garantiert konstante Lichtleistung und maximale Effizienz.

FR

Si la charge solaire est faible, la lampe peut être facilement rechargée en quelques heures grâce à la fonction USB intégrée. Cela garantit une luminosité constante et une efficacité maximale.

ES

Si la carga solar es baja, la luz puede recargarse fácilmente en unas pocas horas mediante la función USB incorporada. Esto garantiza una potencia luminosa constante y la máxima eficiencia.

RO

Dacă încărcarea solară este scăzută, lumina poate fi ușor reîncărată în doar câteva ore utilizând funcția USB încorporată. Acest lucru garantează o ieșire constantă a luminii și o eficiență maximă.

PL

Jeśli poziom naładowania baterii słonecznej jest niski, lampę można łatwo naładować w ciągu zaledwie kilku godzin za pomocą wbudowanej funkcji USB. Gwarantuje to stały strumień światła i maksymalną wydajność.

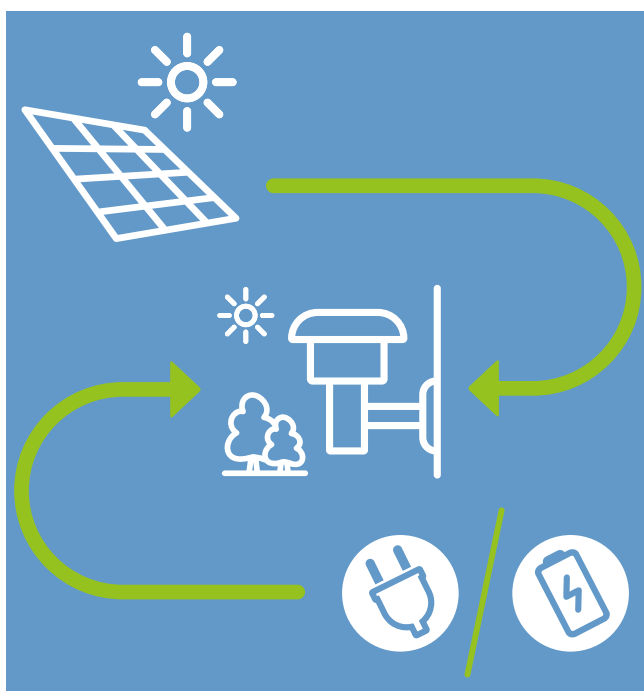

- ✓ 100% Stromkostensparnis während des Solar-Betriebs
- ✓ Sehr hohe Leuchtkraft bis zu 1.000 Lumen
- ✓ Hocheffiziente Solarmodule
- ✓ Bewegungsmelder und Dämmerungssensoren sorgen für eine effiziente Nutzung des Solarstroms und mehr Sicherheit
- ✓ 100% electricity cost savings during solar operation
- ✓ Very high luminosity up to 1,000 lumens
- ✓ Highly efficient solar modules
- ✓ Motion detectors and twilight sensors ensure efficient use of solar power and more safety

# BLYDE

Aluminium Druckguss · Diecast aluminium ·  
 Fonte d'aluminium · Gegoten aluminium · Aluminio fundido ·  
 Pressofusione di alluminio · Fonta aluminiu · Valualumiini ·  
 Barwione aluminium

● 42 | Anthrazit · anthracite

 Bewegungssensor ·  
 Motion sensor

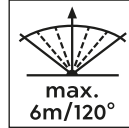
 max.  
 6m/120°

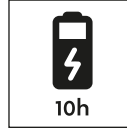
 10h

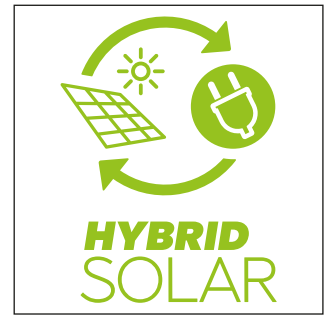

Sockelleuchte · Podestal lamp  
 incl. SMD-LED  
 5 W / 700 Lumen  
 2.300 - 4.000 Kelvin  
**553569142**



 IP65

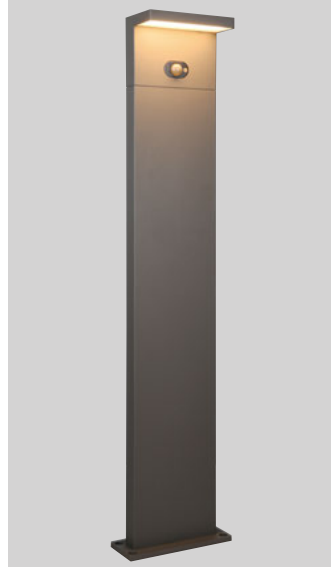
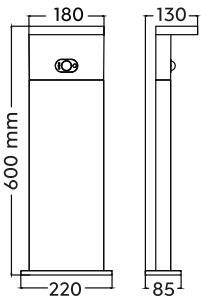

Bodenleuchte · Floor lamp  
 incl. SMD-LED  
 5 W / 700 Lumen  
 2.300 - 4.000 Kelvin  
**453569142**



 IP65

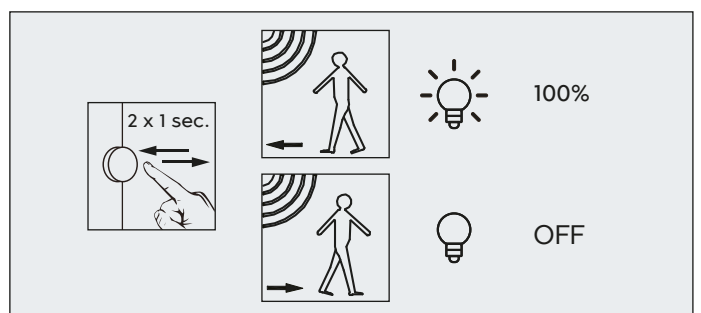
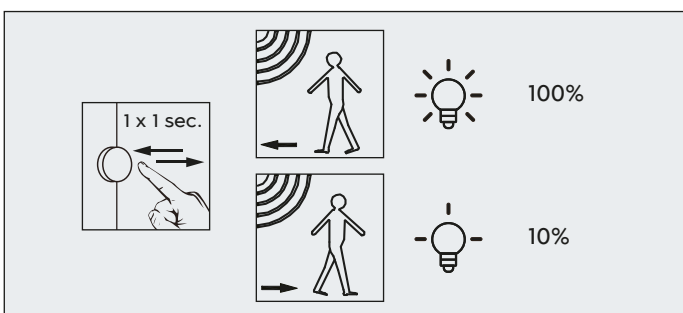
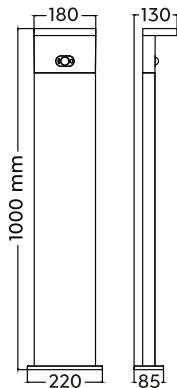





Wandleuchte · Wall lamp  
 incl. SMD-LED  
 5 W / 700 Lumen  
 2.300 - 4.000 Kelvin  
 253569142

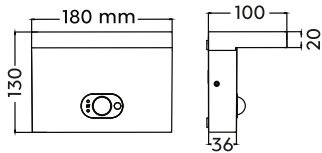

IP65



 Bewegungssensor · Motion sensor

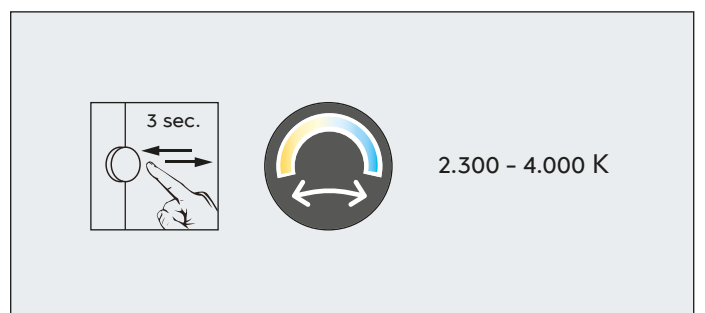
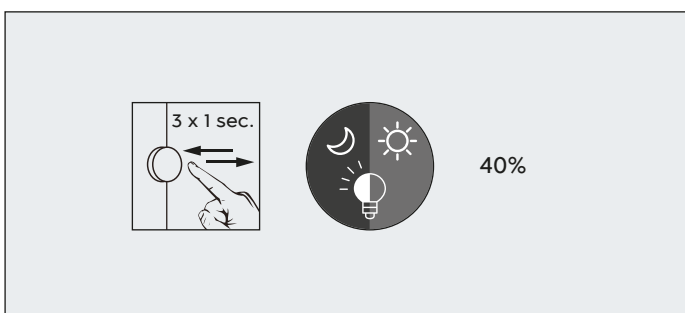
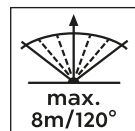

# MALAWI

Aluminium Druckguss · Diecast aluminium ·  
 Fonte d'aluminium · Gegoten aluminium · Aluminio fundido ·  
 Pressofusione di alluminio · Fonta aluminii · Valualumiini ·  
 Barwione aluminium



Bewegungssensor ·  
 Motion sensor

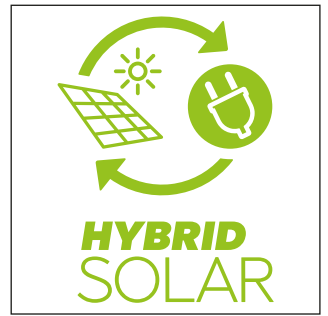
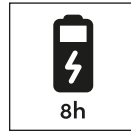
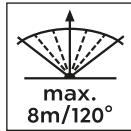

42 | Anthrazit · anthracite



Wandleuchte · Wall lamp  
 incl. SMD-LED  
 5 W / 700 Lumen  
 2.300 - 4.000 Kelvin  
**253769142**



IP65

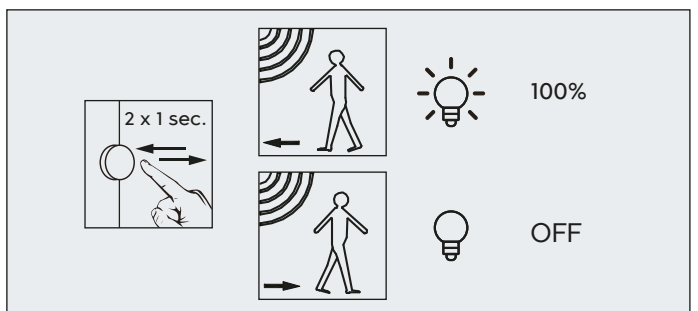
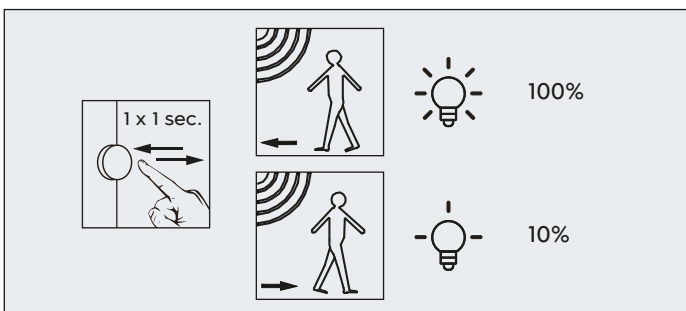
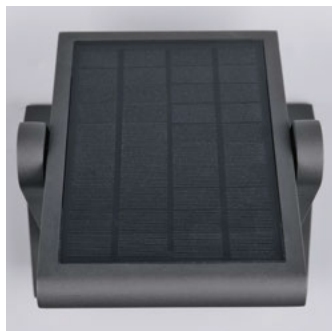
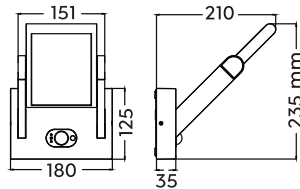





Sockelleuchte · Podestal lamp

incl. SMD-LED  
5 W / 700 Lumen  
2.300 - 4.000 Kelvin  
**553769142**

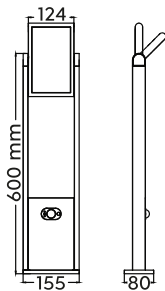

IP65



 Bewegungssensor · Motion sensor

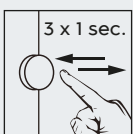
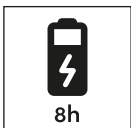

40%



Bodenleuchte · Floor lamp

incl. SMD-LED  
5 W / 700 Lumen  
2.300 - 4.000 Kelvin  
**453769142**



IP65

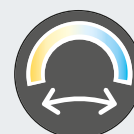
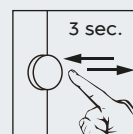
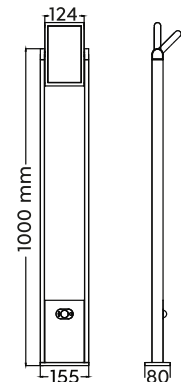

2.300 - 4.000 K

# COLOMBO

Metall, Kunststoff · Metal, plastic ·  
 Metale, plastique · Metaal, kunststof ·  
 Metal, plástico · Metallo, plastica ·  
 Metal, plastic · Metalli, muovi · Metal, plastik

● 32 | Schwarz matt · black mat



Bewegungssensor und Orientierungslicht ·  
 Motion sensor and orientation light

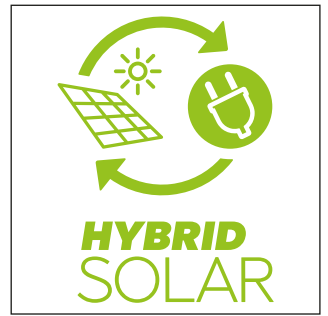
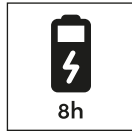
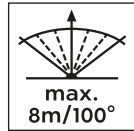

Wandleuchte · Wall lamp  
 incl. SMD-LED  
 5,5 W / 650 Lumen  
 4.000 Kelvin  
**R23286132**

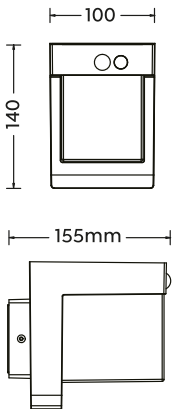

Sockelleuchte · Podestal lamp  
 incl. SMD-LED  
 5,5 W / 650 Lumen  
 4.000 Kelvin  
**R53286132**

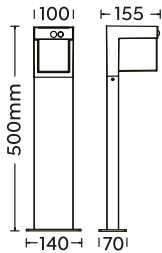

Bodenleuchte · Floor lamp  
 incl. SMD-LED  
 5,5 W / 650 Lumen  
 4.000 Kelvin  
**R43286132**

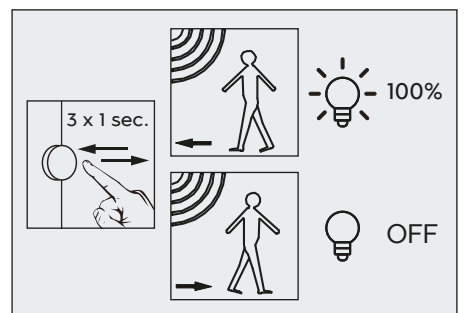
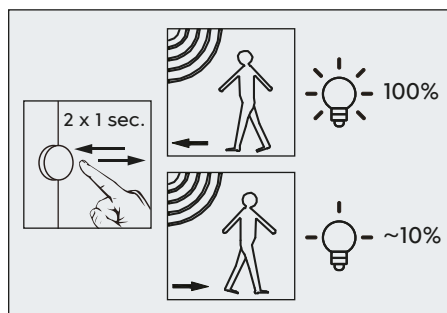
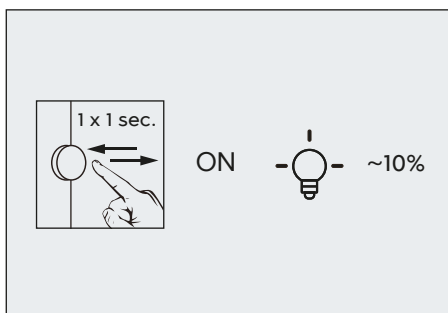
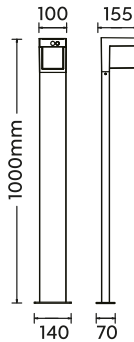



# GORDA

Kunststoff · Plastic ·  
Plastique · Kunststoff · Plástico ·  
Plastica · Plastic · Muovi · Plastik



Bewegungssensor ·  
Motion sensor

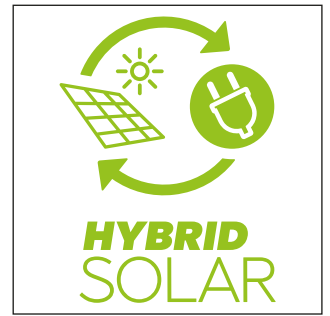

● 32 | Schwarz matt · black mat

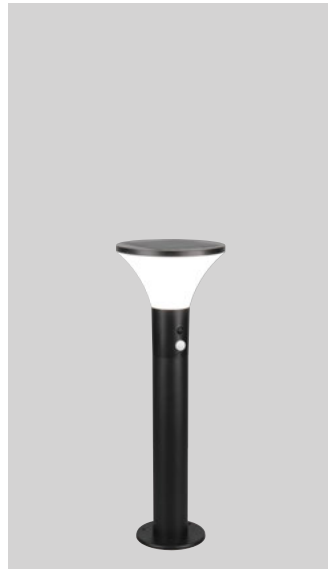
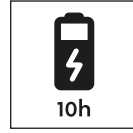
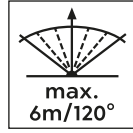
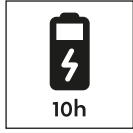
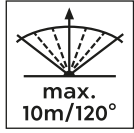

Wandleuchte · Wall lamp

incl. SMD-LED  
3,5 W / 500 Lumen  
4.000 Kelvin

R24676132

Sockelleuchte · Podestal lamp

incl. SMD-LED  
3,5 W / 500 Lumen  
4.000 Kelvin

R54676132

Bodenleuchte · Floor lamp

incl. SMD-LED  
3,5 W / 500 Lumen  
4.000 Kelvin

R44676132

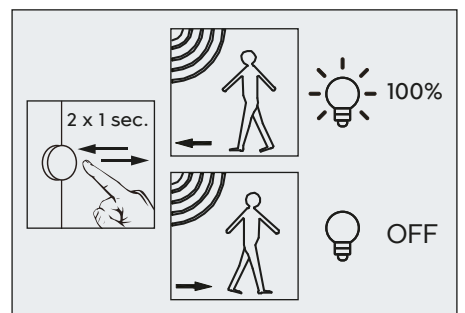
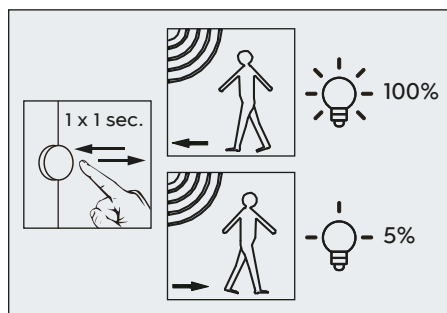
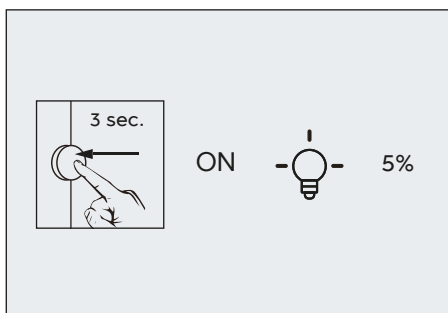
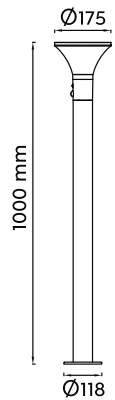
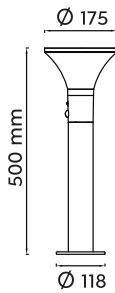
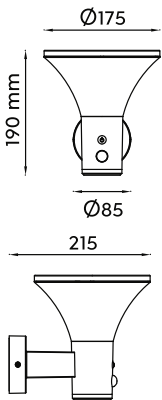



# SILVES

Kunststoff · Plastic ·  
Plastique · Kunststof · Plástico ·  
Plastica · Plastic · Muovi · Plastik

○ 01 | Weiß · white

● 02 | Schwarz · black



Bewegungssensor und Orientierungslicht ·  
Motion sensor and orientation light

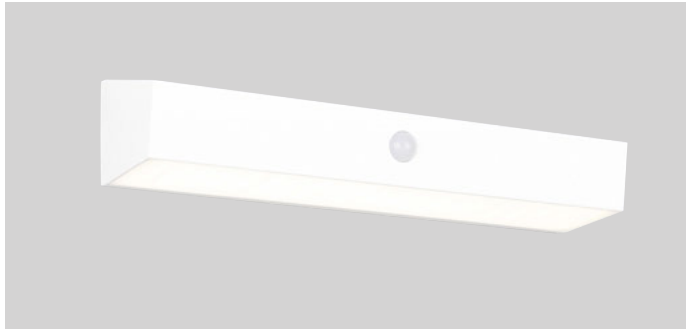
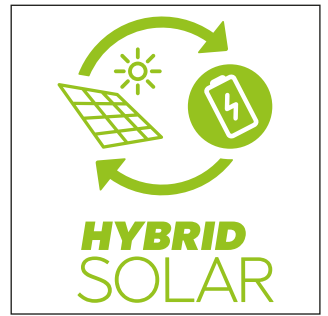
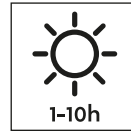
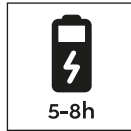
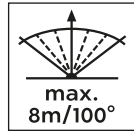

Wandleuchte · Wall lamp

incl. SMD-LED  
6 W / 700 Lumen  
4.000 Kelvin

R23306101  
R23306102

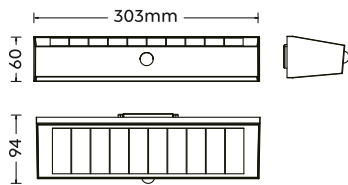

3 Helligkeitsstufen: 100%, 50%, 25%  
3 brightness level: 100%, 50%, 25%

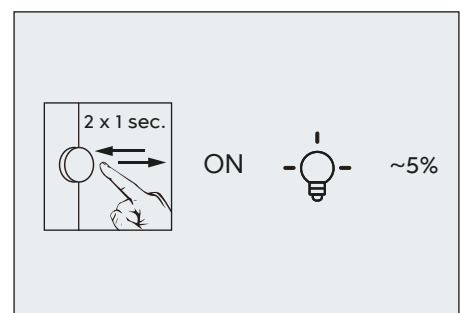
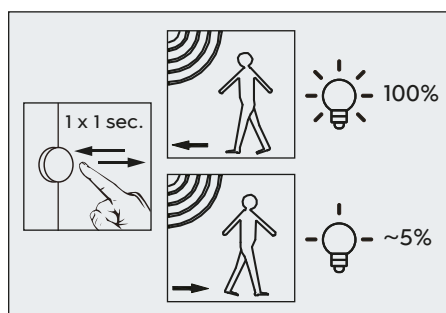
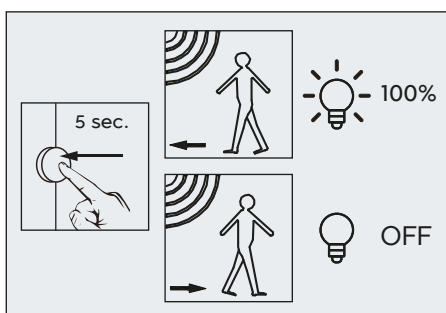

# BILBAO

Kunststoff · Plastic ·  
Plastique · Kunststoff · Plástico ·  
Plastica · Plastic · Muovi · Plastik

○ 01 | Weiß · white

● 02 | Schwarz · black



Bewegungssensor und Orientierungslicht ·  
Motion sensor and orientation light

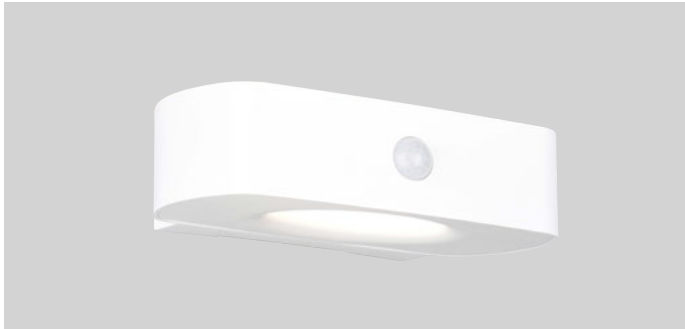
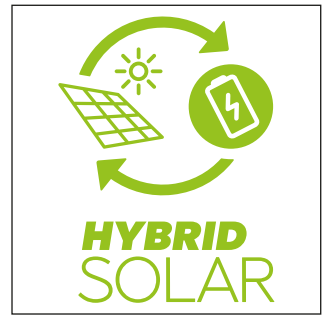
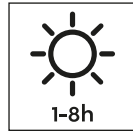
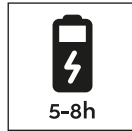
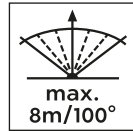

Wandleuchte · Wall lamp

incl. SMD-LED  
6 W / 700 Lumen  
4.000 Kelvin

R23336201  
R23336202

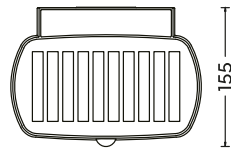
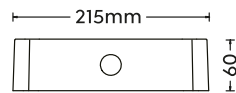

3 Helligkeitsstufen: 100%, 50%, 25%  
3 brightness level: 100%, 50%, 25%

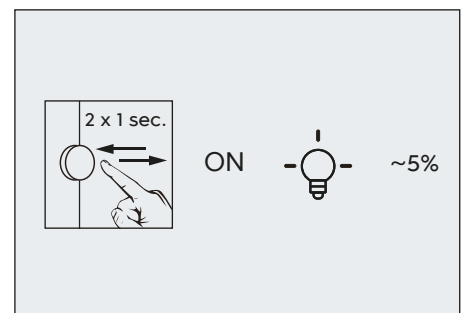
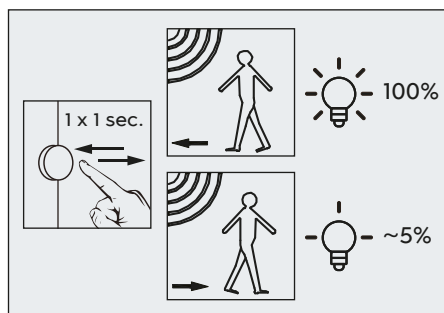
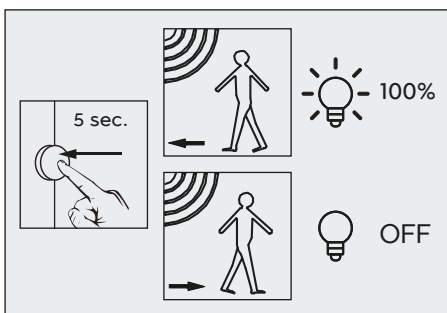

# MORO

Kunststoff · Plastic ·  
Plastique · Kunststoff · Plástico ·  
Plastica · Plastic · Muovi · Plastik

● 32 | Schwarz matt · black mat



Bewegungssensor und Orientierungslicht ·  
Motion sensor and orientation light

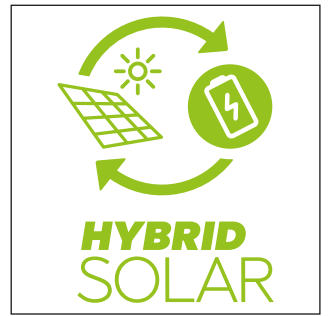
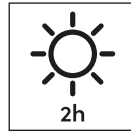
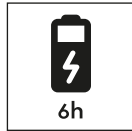
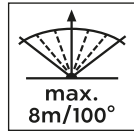

Wandleuchte · Wall lamp

incl. SMD-LED  
8 W / 850 Lumen  
4.000 Kelvin  
R24706132

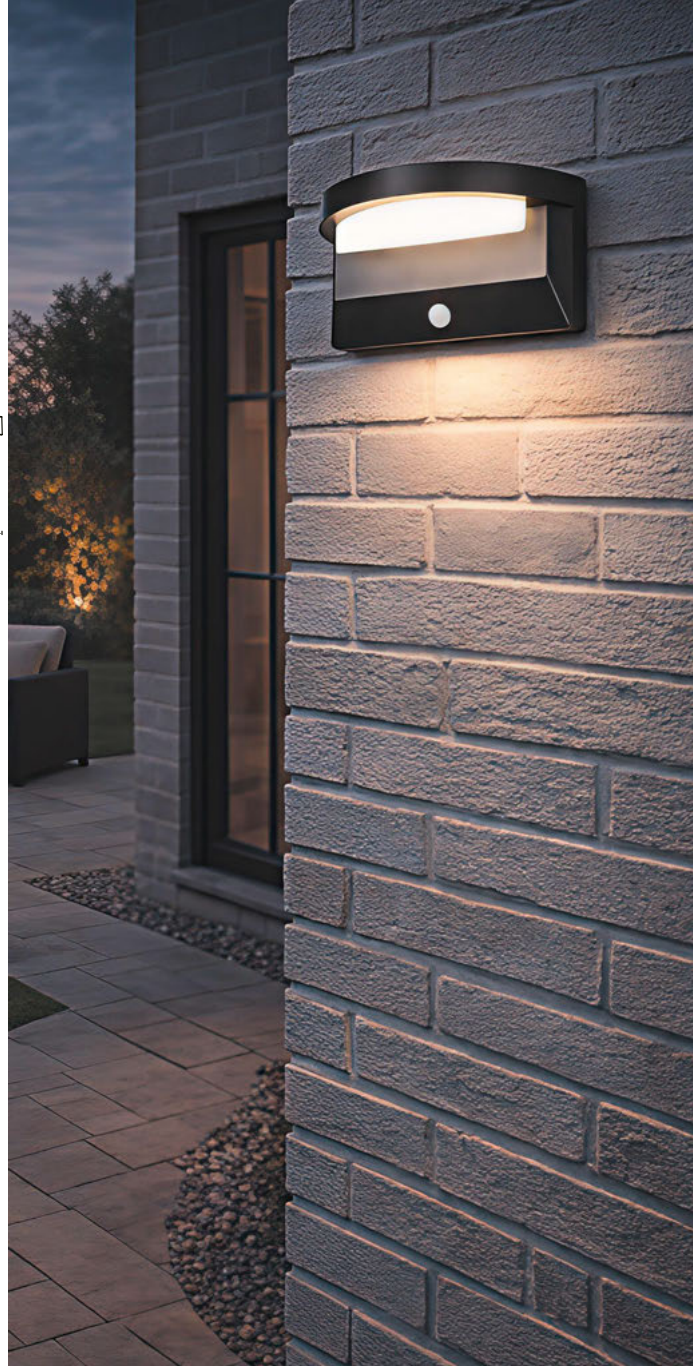
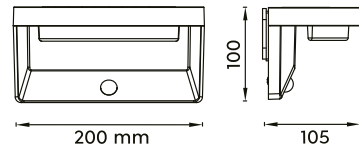

3 Helligkeitsstufen: 100%, 50%, 25%  
3 brightness level: 100%, 50%, 25%

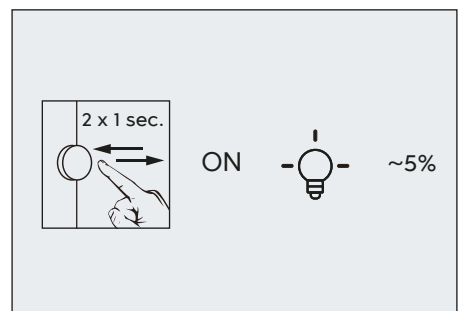
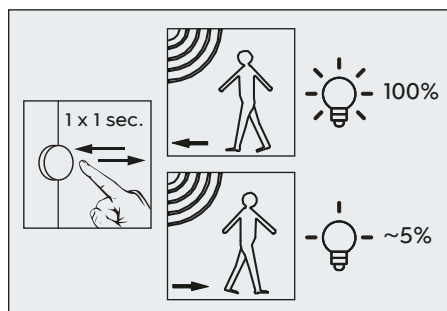
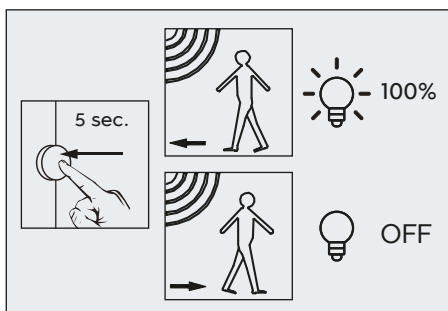

# COBRE

Kunststoff · Plastic ·  
Plastique · Kunststof · Plástico ·  
Plastica · Plastic · Muovi · Plastik

● 32 | Schwarz matt · black mat

 Bewegungssensor und Orientierungslicht ·  
Motion sensor and orientation light

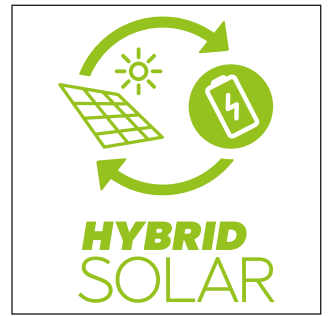
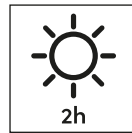
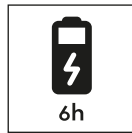
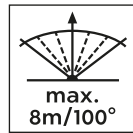

Wandleuchte · Wall lamp  
incl. SMD-LED  
8 W / 850 Lumen  
4.000 Kelvin  
**R24716132**



3 Helligkeitsstufen: 100%, 50%, 25%  
3 brightness level: 100%, 50%, 25%

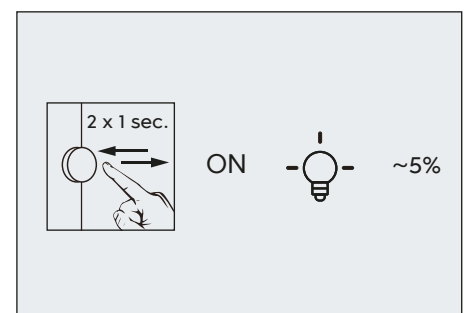
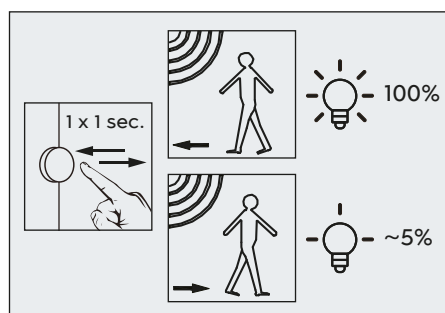
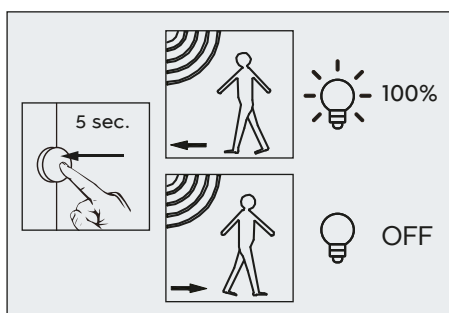
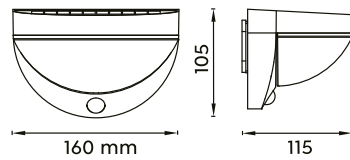

# ALVORADA

Kunststoff · Plastic ·  
Plastique · Kunststoff · Plástico ·  
Plastica · Plastic · Muovi · Plastik

● 02 | Schwarz · black

 Bewegungssensor und Orientierungslicht ·  
Motion sensor and orientation light

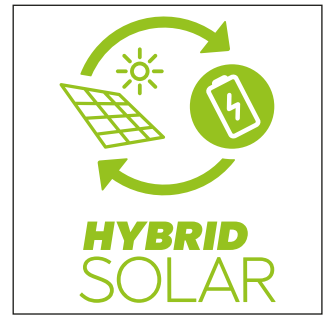
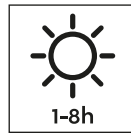
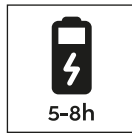
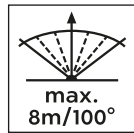

Wandleuchte · Wall lamp

incl. SMD-LED  
6 W / 600 Lumen  
4.000 Kelvin  
R23326102

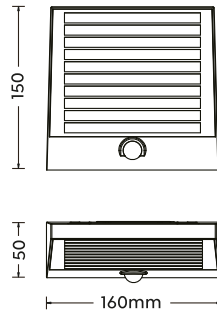

3 Helligkeitsstufen: 100%, 50%, 25%  
3 brightness level: 100%, 50%, 25%

# RAMOS

Kunststoff · Plastic ·  
Plastique · Kunststoff · Plástico ·  
Plastica · Plastic · Muovi · Plastik

● 32 | Schwarz matt · black mat

 Bewegungssensor und Orientierungslicht ·  
Motion sensor and orientation light

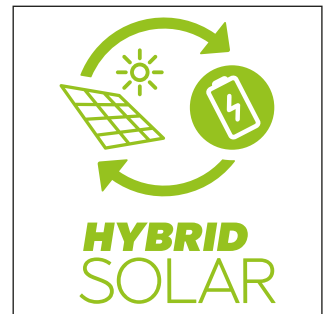
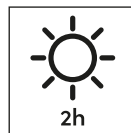
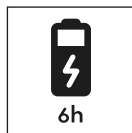
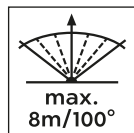

Wandleuchte · Wall lamp

incl. SMD-LED  
8 W / 850 Lumen  
4.000 Kelvin  
R24746232

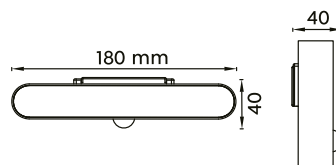

3 Helligkeitsstufen: 100%, 50%, 25%  
3 brightness level: 100%, 50%, 25%

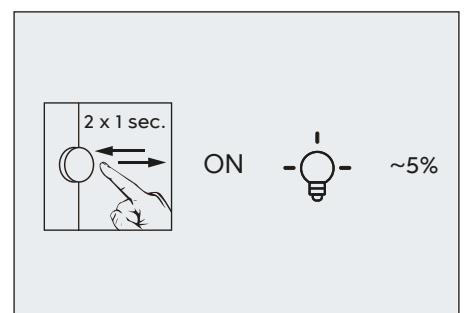
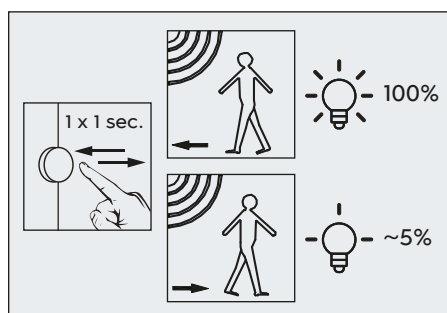
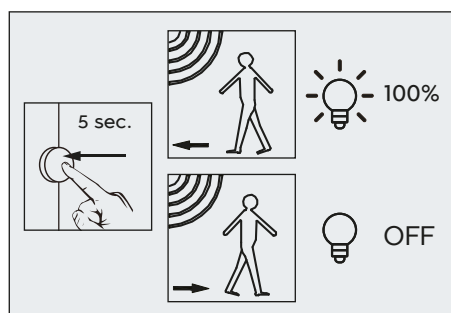

# ATICO

Kunststoff · Plastic ·  
Plastique · Kunststof · Plástico ·  
Plastica · Plastic · Muovi · Plastik

● 32 | Schwarz matt · black mat



Bewegungssensor und Orientierungslicht ·  
Motion sensor and orientation light

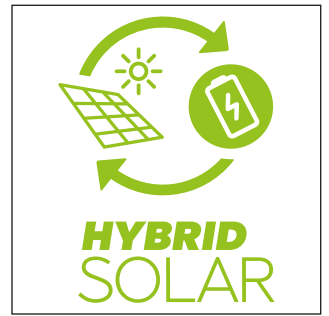
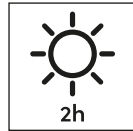
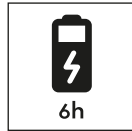
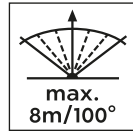

Wandleuchte · Wall lamp  
incl. SMD-LED  
8 W / 850 Lumen  
4.000 Kelvin  
**R24696132**

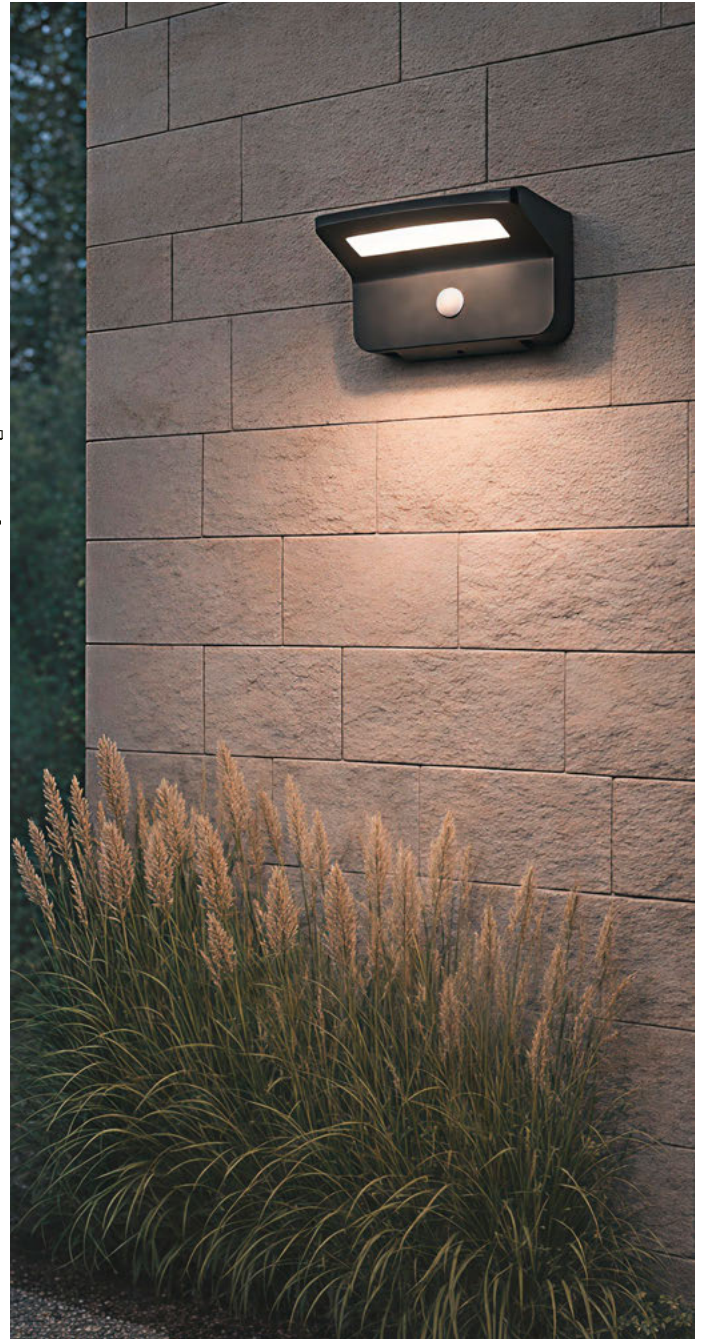
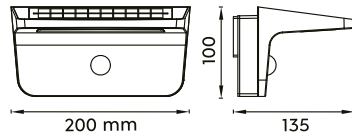

3 Helligkeitsstufen: 100%, 50%, 25%  
3 brightness level: 100%, 50%, 25%

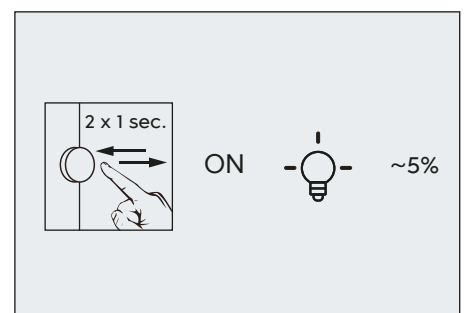
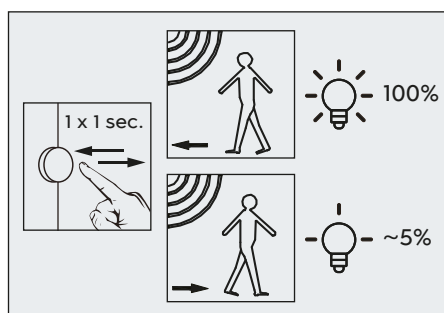
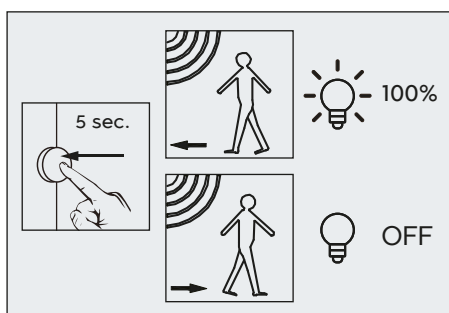

# Mit der Kraft der Sonne nachhaltig beleuchten

Sustainable lighting with the power of the sun

Solarleuchten nutzen ausschließlich die Kraft der Sonne um Licht zu erzeugen. Dabei sind sie extrem umwelt-schonend, sparsam und gleichermaßen praktisch, da sie weder Steckdosen noch einen Anschluss ans Stromnetz benötigen. In Kombination mit moderner LED-Technik bieten Solarleuchten ideales Licht für Haus und Garten.

Solar lamps exclusively use the power of the sun to generate light. At the same time they are extremely environmentally friendly and economical as well as practical, as they need neither sockets nor a connection to the mains supply. In combination with modern LED technology, solar lamps provide an ideal light for home and garden.

Les lampes solaires utilisent exclusivement l'énergie du soleil pour générer de la lumière. En même temps, elles sont extrêmement écologiques, économiques et tout aussi pratiques, car elles ne nécessitent ni prise de courant ni raccordement au réseau électrique. En combinaison avec la technologie LED moderne, les lampes solaires fournissent une lumière idéale pour la maison et le jardin.

Zonnelampen maken uitsluitend gebruik van de kracht van de zon om licht te produceren. Daarbij zijn ze extreem milieuvriendelijk, zuinig en in gelijke mate praktisch, omdat ze noch een stopcontact noch een aansluiting op het stroomnet nodig hebben. In combinatie met moderne ledtechniek bieden zonnelampen ideaal licht voor huis en tuin.





# LED-Solarleuchten

## LED solar lights

Las luces solares usan exclusivamente la energía del sol para generar luz. Al mismo tiempo, son extremadamente ecológicas, económicas e igualmente prácticas, y no necesitan ni enchufes ni conexión a la corriente. En combinación con las modernas técnicas LED, las luces solares ofrecen una luz ideal para la casa y el jardín.

Le lampade solari utilizzano esclusivamente la potenza del sole per generare luce. Allo stesso tempo sono estremamente rispettose dell'ambiente, economiche e pratiche in quanto non richiedono né presa di corrente, né un collegamento alla rete elettrica. In combinazione con la moderna tecnologia LED, le lampade solari forniscono una luce ideale per la casa e il giardino.

Lămpile solare se folosesc în exclusivitate de energia soarelui pentru a genera lumină. În acest context sunt extrem de ecologice, economice și practice în același timp, deoarece nu necesită nici prize și nici conectarea la o rețea electrică. În combinație cu tehnologia modernă LED, lămpile solare oferă lumina ideală pentru casă și grădină.

Aurinkovalaisimet käyttävät auringon energiaa valon tuottamiseen. Samalla ne ovat erittäin ympäristöystävällisiä, taloudellisia ja myös käytännöllisiä, koska ne eivät vaadi pistorasioita tai liitäntää sähköverkkoon. Yhdessä modernin LED-tekniikan kanssa aurinkovalaisimet tarjoavat ihanteellisen valaistuksen kotiin ja puutarhaan.

Lampy solarne wykorzystują moc słońca do generowania światła. Są one przy tym niezwykle przyjazne dla środowiska, ekonomiczne i jednocześnie praktyczne, ponieważ nie wymagają gniazd ani podłączenia do sieci elektrycznej. W połączeniu z nowoczesną technologią LED lampy solarne zapewniają idealne oświetlenie domu i ogrodu.

# VIAMAO

Kunststoff · Plastic ·  
Plastique · Kunststoff · Plástico ·  
Plastica · Plastic · Muovi · Plastik

01 | Weiß · white



Bewegungssensor und Orientierungslicht ·  
Motion sensor and orientation light

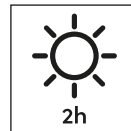
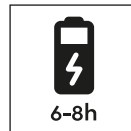
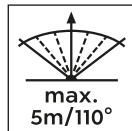

Wandleuchte · Wall lamp  
incl. SMD-LED  
4 W / 400 Lumen  
4.000 Kelvin  
**R23166101**

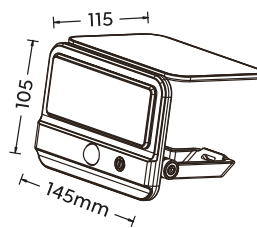

# OLINDA

Kunststoff · Plastic ·  
Plastique · Kunststoff · Plástico ·  
Plastica · Plastic · Muovi · Plastik

02 | Schwarz · black



Bewegungssensor und Orientierungslicht ·  
Motion sensor and orientation light

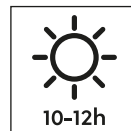
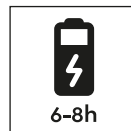
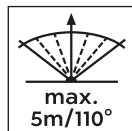

Wandleuchte · Wall lamp  
incl. SMD-LED  
2,5 W / 250 Lumen  
4.000 Kelvin  
**R23156102**

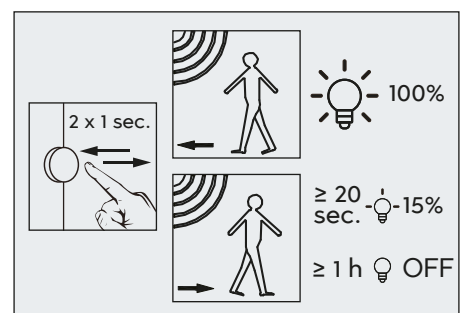
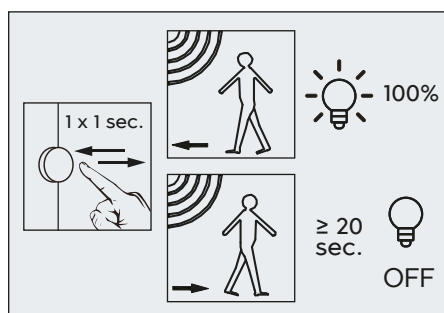
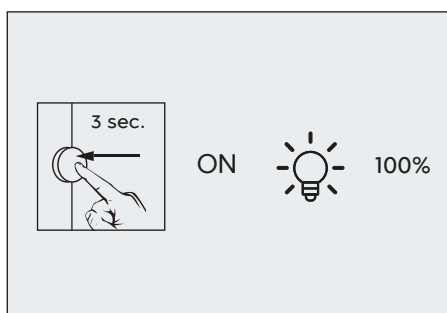
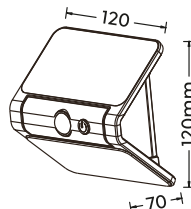

# LAGOAS

Kunststoff · Plastic ·  
Plastique · Kunststof · Plástico ·  
Plastica · Plastic · Muovi · Plastik



Bewegungssensor und Orientierungslicht ·  
Motion sensor and orientation light

02 | Schwarz · black

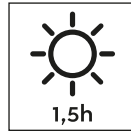
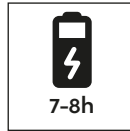
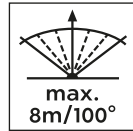

Wandleuchte · Wall lamp

incl. SMD-LED  
3 W / 350 Lumen  
4.000 Kelvin

**R23176102**

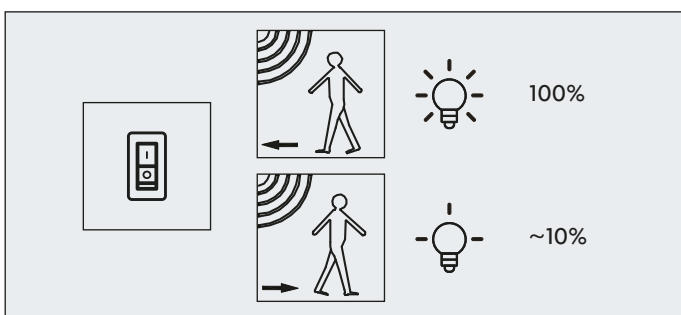
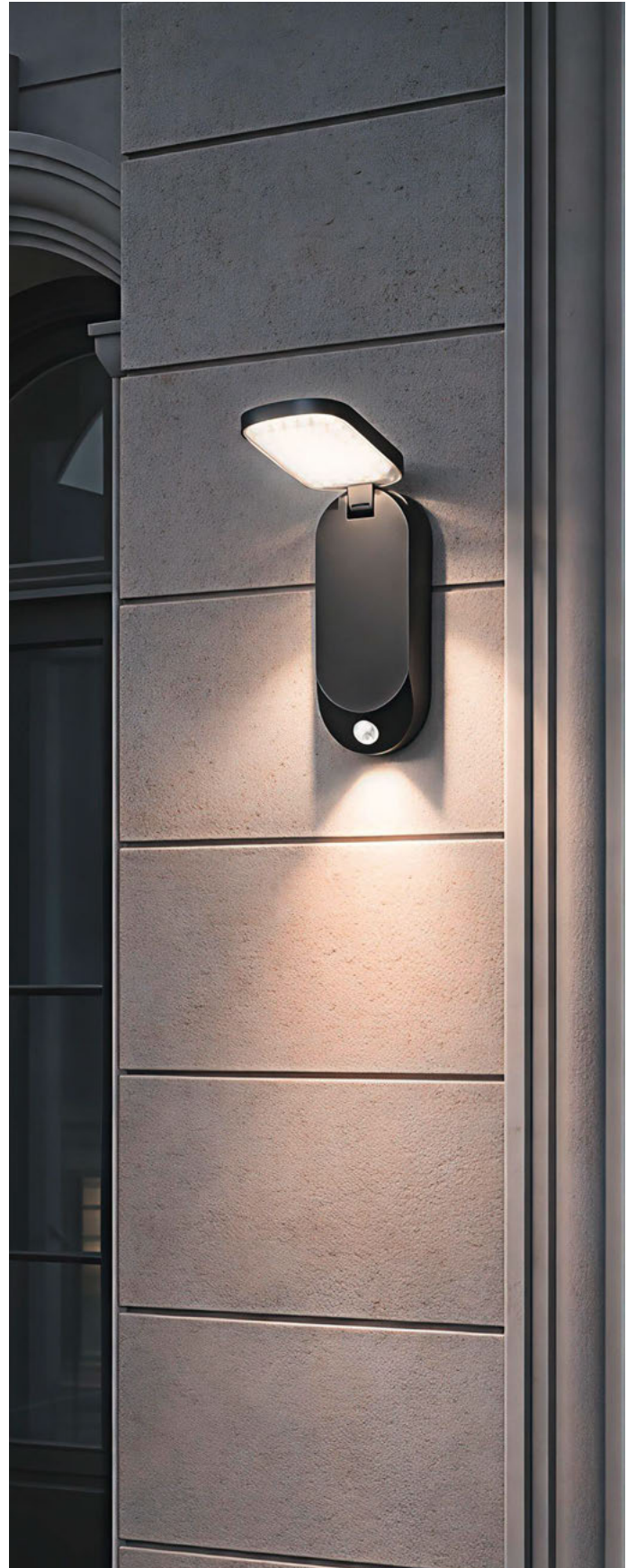
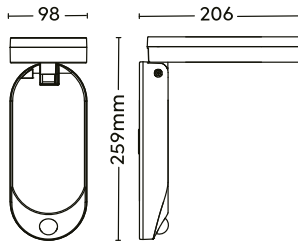

# POSADAS

Kunststoff · Plastic ·  
Plastique · Kunststof · Plástico ·  
Plastica · Plastic · Muovi · Plastik

42 | Anthrazit · anthracite



Wandleuchte · Wall lamp  
incl. SMD-LED  
4,5 W / 290 Lumen  
3.000 Kelvin  
**R22251142**

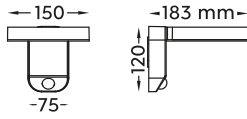

Bewegungssensor ·  
Motion sensor

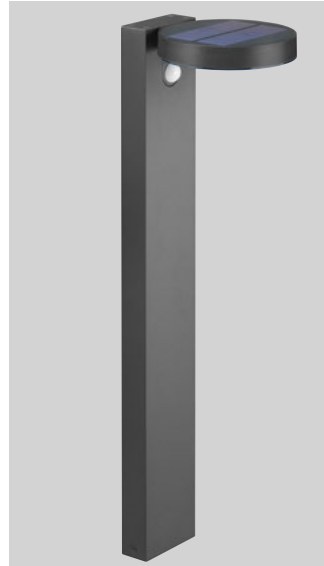
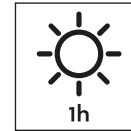
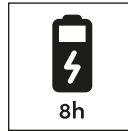
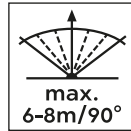

Bodenleuchte · Floor lamp  
incl. SMD-LED  
4,5 W / 290 Lumen  
3.000 Kelvin  
**R42251142**

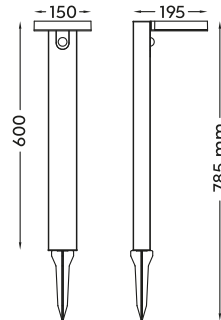

# ESQUEL

Kunststoff · Plastic ·  
Plastique · Kunststof · Plástico ·  
Plastica · Plastic · Muovi · Plastik

42 | Anthrazit · anthracite



Wandleuchte · Wall lamp  
incl. SMD-LED  
4,5 W / 290 Lumen  
3.000 Kelvin  
**R22261142**

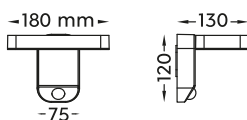

Bewegungssensor ·  
Motion sensor

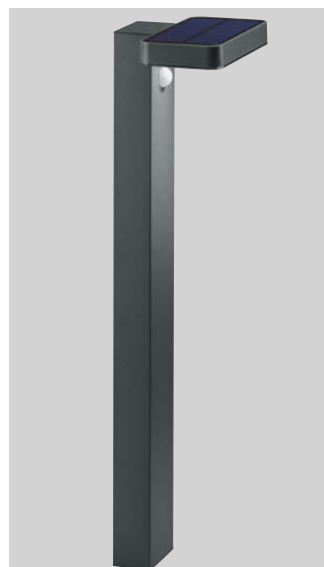
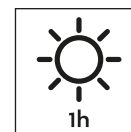
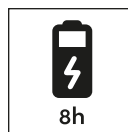
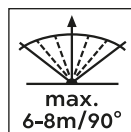

Bodenleuchte · Floor lamp  
incl. SMD-LED  
4,5 W / 290 Lumen  
3.000 Kelvin  
**R42261142**

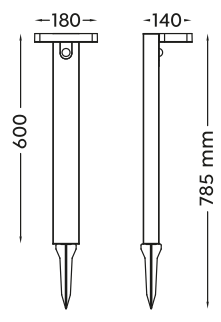





# MOURA

Aluminium Druckguss, Kunststoff · Diecast aluminium, plastic ·  
 Fonte d'aluminium, plastique · Gegoten aluminium, kunststof ·  
 Aluminio fundido, plástico · Pressofusione di alluminio, plastica ·  
 Fonta aluminiu, plastic · Valualumiini, muovu · Barwione aluminium, plastik

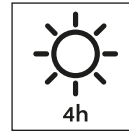
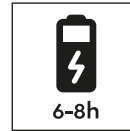
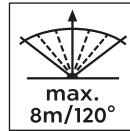

 Bewegungssensor ·  
 Motion sensor



 32 | Schwarz matt · black mat



Wandleuchte · Wall lamp  
 incl. SMD-LED  
 10 W / 1.100 Lumen  
 3.000 + 4.000 + 6.000 Kelvin  
**R22109132**



 IP54

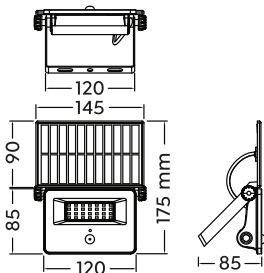

Wandleuchte · Wall lamp  
 incl. SMD-LED  
 18 W / 2.150 Lumen  
 3.000 + 4.000 + 6.000 Kelvin  
**R22106132**



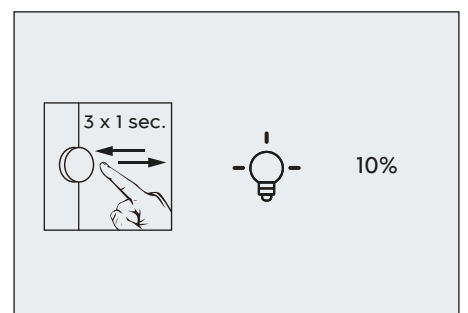
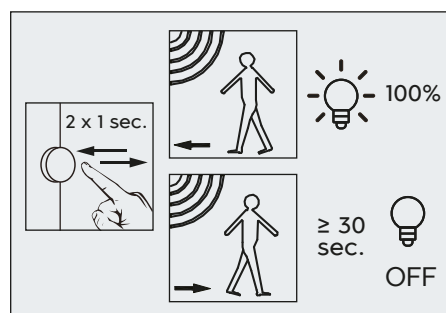
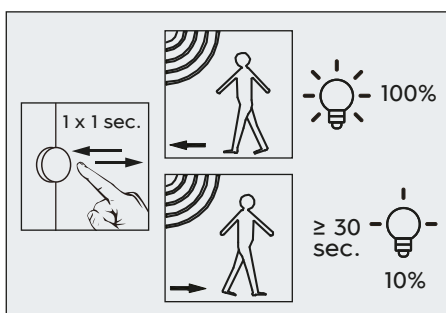
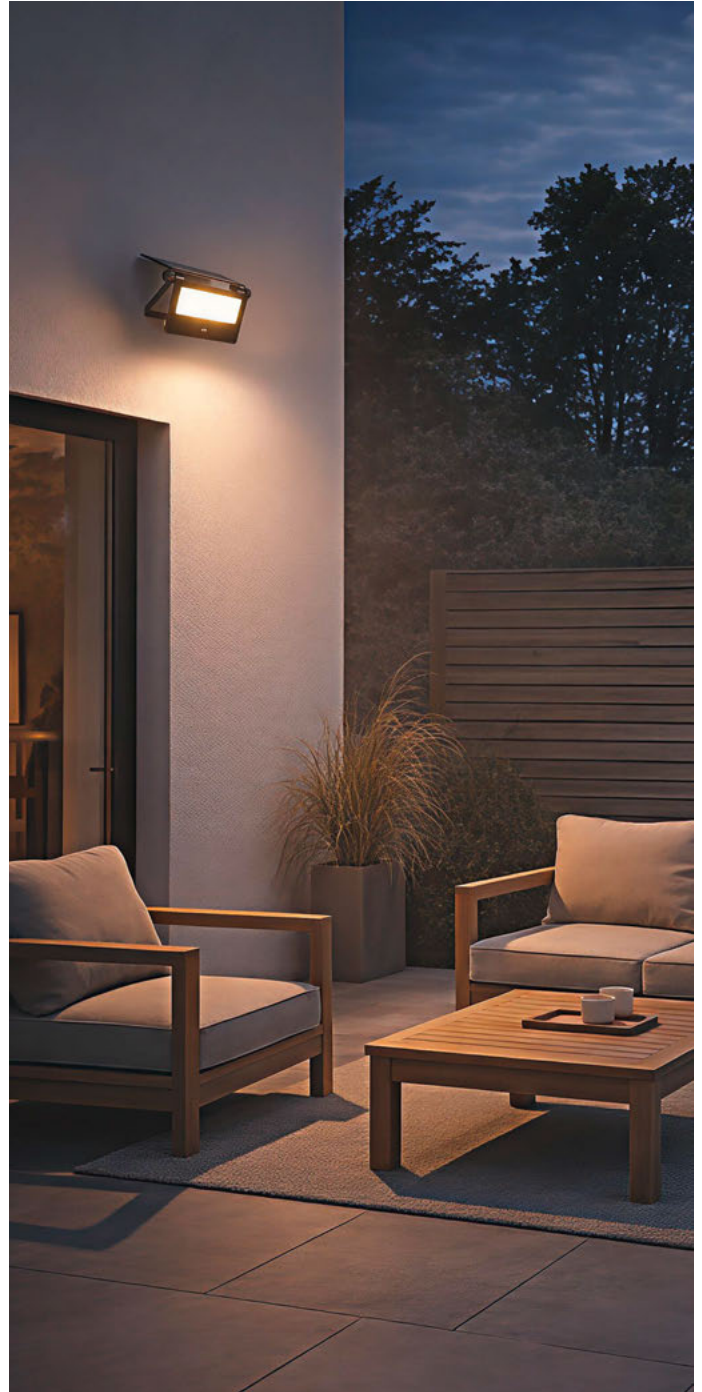
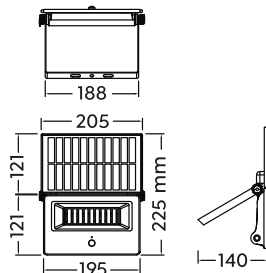

 IP54



# SALTA

Metall, Acryl · Metal, acryl ·  
 Metale, acryl · Metaal, acryl · Metal, acrílico ·  
 Metallo, acrílico · Metal, acrylic · Metalli, akryyli · Metal, akryl

-  **07** | Nickel matt · nickel mat
-  **42** | Anthrazit · anthracite



 Bewegungssensor ·  
 Motion sensor

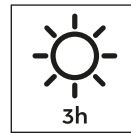
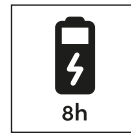
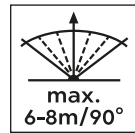

Wandleuchte · Wall lamp  
 incl. SMD-LED  
 3 W / 165 Lumen  
 3.000 Kelvin  
**R22231107**  
**R22231142**

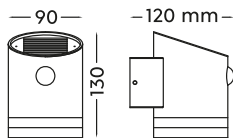

# FOMOSA

Kunststoff · Plastic ·  
 Plastique · Kunststof · Plástico ·  
 Plastica · Plastic · Muovi · Plastik

-  **42** | Anthrazit · anthracite



 Bewegungssensor ·  
 Motion sensor

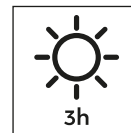
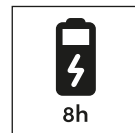
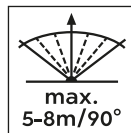

Wandleuchte · Wall lamp  
 incl. SMD-LED  
 4,8 W / 340 Lumen  
 3.000 Kelvin  
**R22281142**

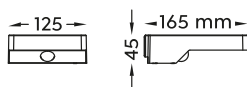

# MACAPA

Kunststoff · Plastic ·  
Plastique · Kunststoff · Plástico ·  
Plastica · Plastic · Muovi · Plastik

01 | Weiß · white



Bewegungssensor und Orientierungslicht ·  
Motion sensor and orientation light

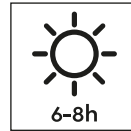
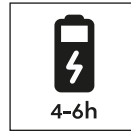
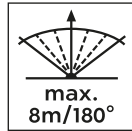

Wandleuchte · Wall lamp

incl. SMD-LED  
5 W / 390 Lumen  
4.000 Kelvin

R23066101

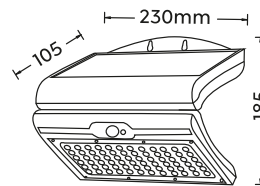

# DIADEMA

Kunststoff · Plastic ·  
Plastique · Kunststoff · Plástico ·  
Plastica · Plastic · Muovi · Plastik

01 | Weiß · white



Bewegungssensor und Orientierungslicht ·  
Motion sensor and orientation light

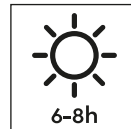
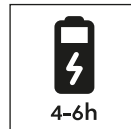
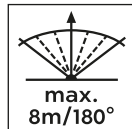

Wandleuchte · Wall lamp

incl. SMD-LED  
3,5 W / 300 Lumen  
4.000 Kelvin

R23146101

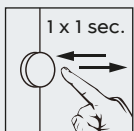
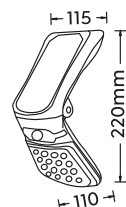

ON



100%



100%



≥ 20 sec.





~5%

# ACORA

Kunststoff · Plastic ·  
Plastique · Kunststoff · Plástico ·  
Plastica · Plastic · Muovi · Plastik



 Bewegungssensor ·  
Motion sensor

 32 | Schwarz matt · black mat

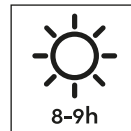
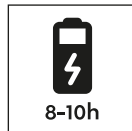
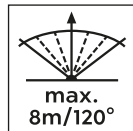

Wandleuchte · Wall lamp

incl. SMD-LED  
18 W / 2600 Lumen  
4.000 Kelvin

R221891**32**

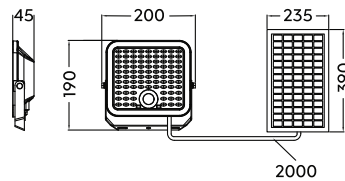

Helligkeit und Leuchtdauer über  
Timer einstellbar ·  
Brightness and light duration  
adjustable via timer

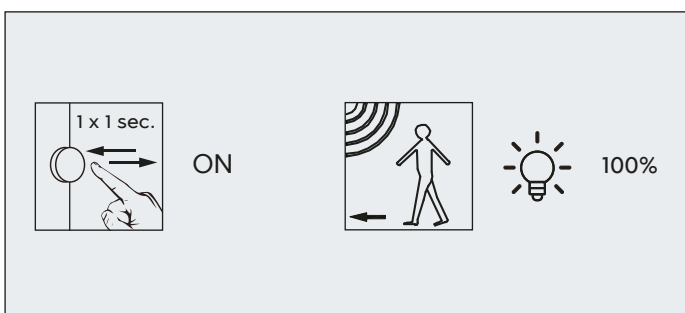

# ELVAS

Kunststoff · Plastic ·  
Plastique · Kunststoff · Plástico ·  
Plastica · Plastic · Muovi · Plastik

○ **31** | Weiß matt · white mat

● **32** | Schwarz matt · black mat



Bewegungssensor ·  
Motion sensor



Dämmerungssensor ·  
Dusk sensor

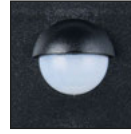
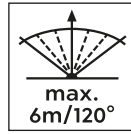

31



32

Wandleuchte · Wall lamp

incl. SMD-LED  
3 W / 380 Lumen  
4.000 Kelvin

R251296**31**  
R251296**32**

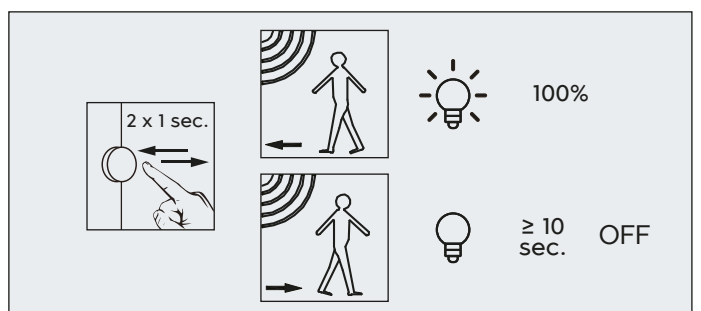
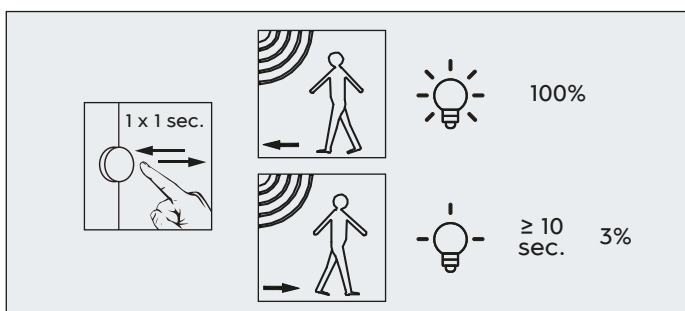
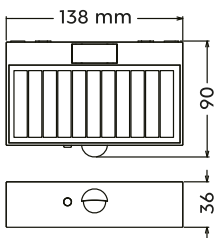

# TALCA

Kunststoff · Plastic ·  
Plastique · Kunststoff · Plástico ·  
Plastica · Plastic · Muovi · Plastik

○ 31 | Weiß matt · white mat

● 32 | Schwarz matt · black mat



 Bewegungssensor ·  
Motion sensor

 Dämmerungssensor ·  
Dusk sensor

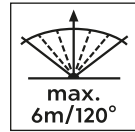

Wandleuchte · Wall lamp  
incl. SMD-LED  
2,5 W / 330 Lumen  
3.000 + 4.000 + 6.000 Kelvin  
**R25119631**  
**R25119632**

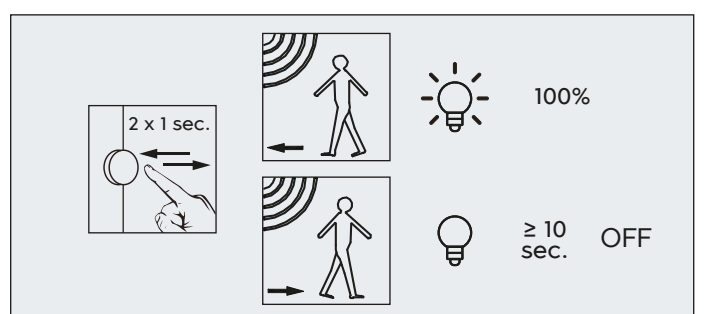
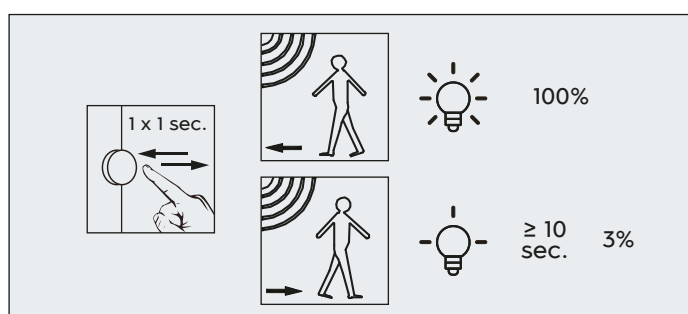
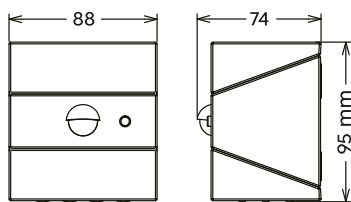

# MELO

Kunststoff · Plastic ·  
Plastique · Kunststof · Plástico ·  
Plastica · Plastic · Muovi · Plastik



RGBW Farbwechsler ·  
RGBW Colorchanging



01 | Weiß · white



Gartenleuchte · Garden lamp  
incl. RGBW-LED  
0,5 W / 30 Lumen  
3.000 Kelvin  
**R55326101**

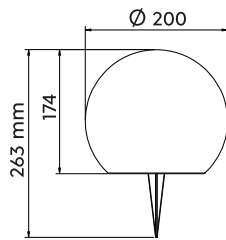

Gartenleuchte · Garden lamp  
incl. RGBW-LED  
0,5 W / 30 Lumen  
3.000 Kelvin  
**R55326901**

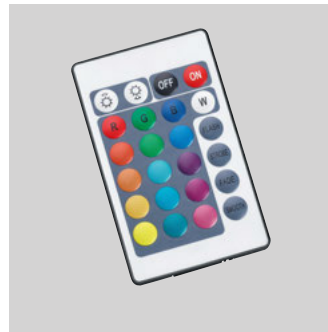
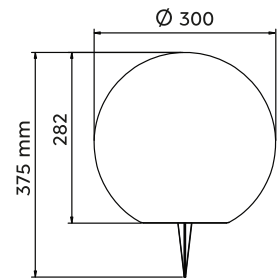



# OBIDOS

Kunststoff · Plastic ·  
Plastique · Kunststoff · Plástico ·  
Plastica · Plastic · Muovi · Plastik

● 32 | Schwarz matt · black mat



Dämmerungssensor ·  
Dusk sensor



7h



5,5h

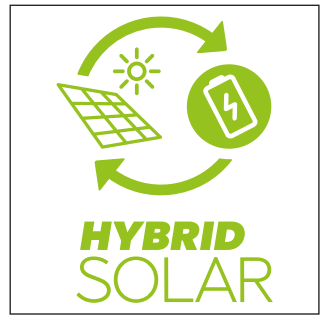

Strahler · Spot

incl. 3 x SMD-LED  
3 x 0,5 W / 3 x 35 Lumen  
4.000 Kelvin

R83256332

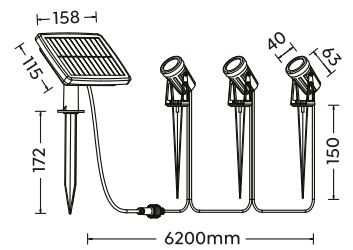



# FESTIVAL

Kunststoff · Plastic ·  
 Plastique · Kunststoff · Plástico ·  
 Plastica · Plastic · Muovi · Plastik

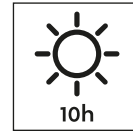
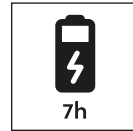
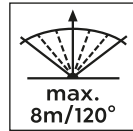

 Dämmerungssensor ·  
 Dusk sensor



 32 | Schwarz matt · black mat



Strahler · Spot  
 incl. SMD-LED  
 1 W / 35 Lumen  
 3.000 Kelvin  
**R84756232**

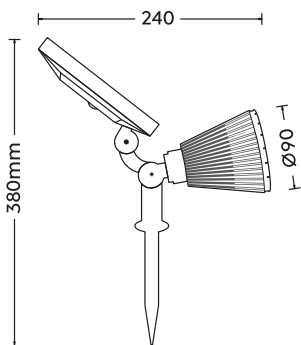

# MOOD

Kunststoff · Plastic ·  
Plastique · Kunststoff · Plástico ·  
Plastica · Plastic · Muovi · Plastik

● 32 | Schwarz matt · black mat

☾☀️ Dämmerungssensor ·  
Dusk sensor

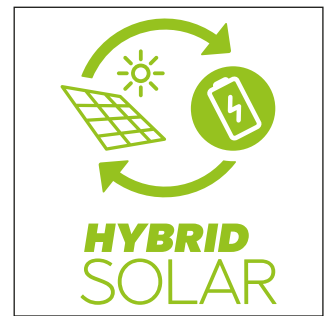
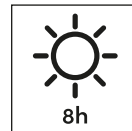
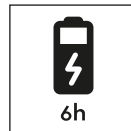

Lichterkette · Fairy lights  
incl. 10 x LED-E12  
10 x 0,5 W / 10 x 30 Lumen  
2.700 Kelvin  
R74761132

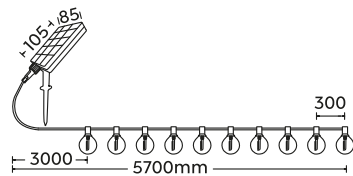

# CAMPUS

Metall, Kunststoff · Metal, plastic ·  
Metale, plastique · Metaal, kunststof · Metal, plástico ·  
Metallo, plastica · Metal, plastic · Metalli, muovi · Metal, plastik

● 32 | Schwarz matt · black mat

☾☀️ Dämmerungssensor ·  
Dusk sensor

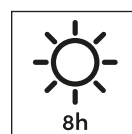
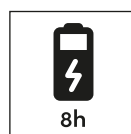

3er Set / Set 3



Gartenleuchte · Garden lamp  
incl. 3 x SMD-LED  
3 x 0,1 W  
R35146132

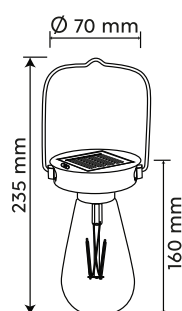

# MOOD

Kunststoff · Plastic ·  
Plastique · Kunststoff · Plástico ·  
Plastica · Plastic · Muovi · Plastik

● 32 | Schwarz matt · black mat

☾☀️ Dämmerungssensor ·  
Dusk sensor

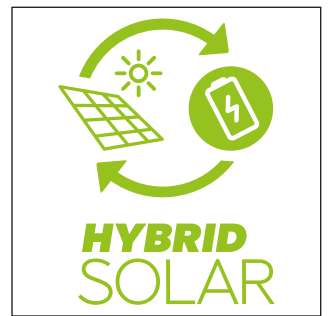
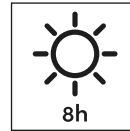
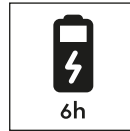

Lichterkette · Fairy lights  
incl. 10 x LED-E12  
10 x 0,5 W / 10 x 30 Lumen  
2.700 Kelvin  
**R74761932**

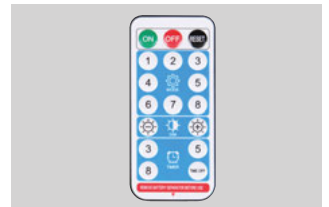
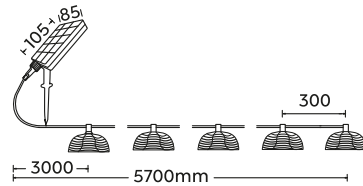

Gracias a la batería integrada, las luces transportables son flexibles y aportan puntos de atención excitantes al jardín, al balcón o a la terraza - ¡y sin ningún tipo de cables! Se consigue el ambiente adecuado con otras características especiales adicionales como el modificador de color RGB o la función Bluetooth para escuchar música sin cables. La iluminación perfecta para pasar la tarde con la familia y los amigos.

Dank integriertem Akku sind die transportablen Leuchten flexibel und setzen spannende Akzente im Garten, auf dem Balkon oder der Terrasse - ganz ohne Kabel! Für die richtige Stimmung sorgen zusätzliche Highlights wie RGB-Farbwechsler oder Bluetooth-Funktion für kabelloses Musik hören. Die perfekte Beleuchtung für gemeinsame Abendstunden mit Familie und Freunden.

Grazie alla batteria ricaricabile integrata, le lampade portatili sono flessibili e creano accenti emozionanti in giardino, sul balcone o sulla terrazza - senza cavi! Ulteriori punti di forza come il cambiacolori RGB o la funzione Bluetooth per l'ascolto di musica senza fili assicurano il giusto feeling. L'illuminazione perfetta per le ore serali da trascorrere insieme alla famiglia e agli amici.

Integrated rechargeable batteries lets you flexibly use these easily transportable lights to accent your garden, balcony or terrace in an exciting way, all without any cables! Additional highlights like an RGB colour wheels and Bluetooth for streaming music wirelessly provide just the right mood. The perfect lighting for spending evening hours with family and friends.

Datorită acumulatorului integrat, lămpile transportabile sunt flexibile și oferă un aspect atrăgător în grădină, pe balcon sau pe terasă - fără cablu! Atmosfera potrivită este asigurată de jocurile suplimentare de lumină cum ar fi schimbarea culorilor RGB sau funcția Bluetooth pentru a asculta muzică fără cablu. Iluminarea perfectă pentru orele de seară cu familia și prietenii.

Grâce à la batterie rechargeable intégrée, les lampes transportables sont flexibles et mettent des accents excitants dans le jardin, sur le balcon ou la terrasse - sans aucun câble ! D'autres fonctions marquantes garantissent une bonne ambiance, telles que le changeur de couleurs RVB ou la fonction Bluetooth pour l'écoute de musique sans fil. L'éclairage parfait pour les soirées partagées avec la famille et les amis.

Integroidun ladattavan akun ansiosta siirrettävät valaisimet ovat joustavia ja muodostavat jännittäviä korostuksia puutarhaan, parvekkeelle tai terassille - ilman kaapeleita! Lisäkorostukset, kuten RGB-väri vaihtajat tai Bluetooth-toiminto langattomaan musiikin kuuntelun, takaavat oikean ilmapiirin. Täydellinen valaistus illanviettoon yhdessä perheen ja ystävien kanssa.





Dankzij de geïntegreerde accu zijn de verplaatsbare lampen flexibel en zorgen voor mooie accenten in de tuin, op het balkon of op het terras, en dat helemaal zonder kabel! Voor de juiste stemming zorgen extra hoogtepunten zoals de RGB-kleurenwisselaar of Bluetooth-functie om draadloos muziek te beluisteren. De perfecte verlichting om 's avonds aangenaam te vertoeven met vrienden en familie.



Dzięki akumulatorowi przenośne lampy są elastyczne w ustawieniu i tworzą ekscytujące akcenty w ogrodzie, na balkonie lub tarasie - bez żadnych kabli! Odpowiedni nastrój zapewnią dodatkowe urządzenia, takie jak zmieniające kolorów RGB lub funkcja Bluetooth do bezprzewodowego słuchania muzyki. Doskonałe oświetlenie wspólnych wieczorów z rodziną i przyjaciółmi.



# SUAREZ

Metall · Metal ·  
Metale · Metaal · Metal ·  
Metallo · Metal · Metalli · Metal

-  **31** | Weiß matt · white mat
-  **32** | Schwarz matt · black mat
-  **49** | Pistaziengrün · pistachio green
-  **66** | Sand · sable

-  On/Off Touch Funktion ·  
On/Off Touch function
-  Sensordimmer ·  
Sensor dimmer
-  USB-C Anschluss ·  
USB-C connection

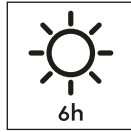
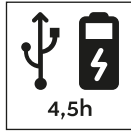

OUTDOOR  
living



Tischleuchte · Table lamp  
incl. SMD-LED  
1,5 W / 200 Lumen  
3.000 Kelvin  
R57706131  
R57706132  
R57706149  
R57706166



 Inklusive Ladestation ·  
Charging station included



Stehleuchte · Floor lamp  
incl. SMD-LED  
1,5 W / 200 Lumen  
3.000 Kelvin  
R57706131  
R57706132  
R57706149  
R57706166

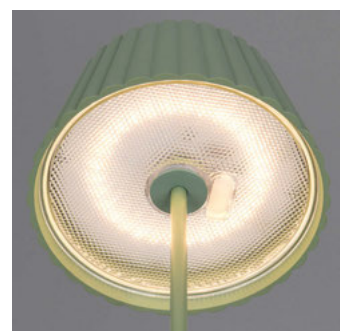
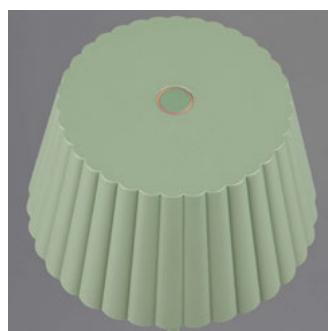
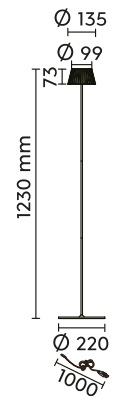



# FERNANDEZ

Metall, Kunststoff · Metal, plastic ·  
 Metale, plastique · Metaal, kunststof · Metal, plástico ·  
 Metallo, plastica · Metal, plastic · Metalli, muovi · Metal, plastik

○ 31 | Weiß matt · white mat

● 32 | Schwarz matt · black mat

☾ Lichtfarbe einstellbar ·  
 Adjustable light color

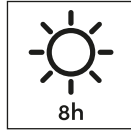
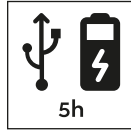

OUTDOOR  
 living



Tischleuchte · Table lamp  
 incl. SMD-LED  
 1,5 W / 130 Lumen  
 2.700 + 4.000 + 6.000 Kelvin  
**R54096131**  
**R54096132**

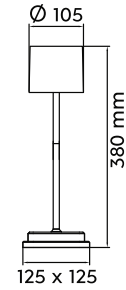
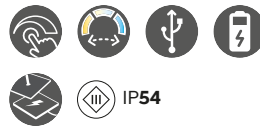

6er Set / Set 6  
 Inklusive Ladestation  
 Charging station included  
**R54096631**  
**R54096632**

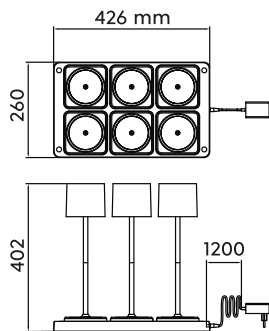

Ladestation · Charging station  
**R54099602**

☼ IP20

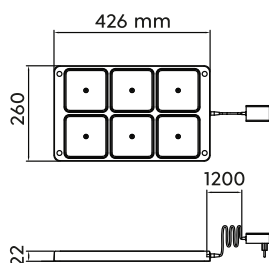

# LENNON

Kunststoff · Plastic ·  
Plastique · Kunststoff · Plástico ·  
Plastica · Plastic · Muovi · Plastik

- 01 | Weiß · white
- 02 | Schwarz · black
- 49 | Pistaziengrün · pistachio green
- 83 | Illuminate Gelb · illuminate yellow

- 4 fach TOUCH ·  
4 level Touch function
- USB-C Anschluss ·  
USB-C connection

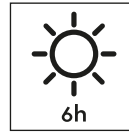
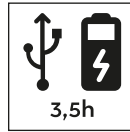

OUTDOOR  
living



Tischleuchte · Table lamp

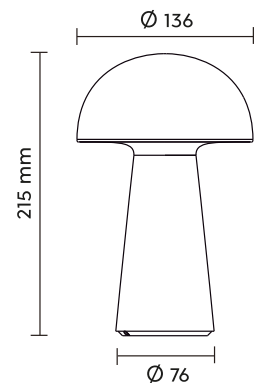

incl. SMD-LED  
2 W / 180 Lumen  
3.000 Kelvin  
R52176101  
R52176102  
R52176149  
R52176183



# DIAZ

Metall · Metal ·  
 Metale · Metaal · Metal ·  
 Metallo · Metal · Metalli · Metal

- 31** | Weiß matt · white mat
- 32** | Schwarz matt · black mat
- 49** | Pistaziengrün · pistachio green
- 66** | Sand · sable
- 77** | Ultimate Grau · ultimate grey

-  Lichtfarbe stufenlos einstellbar ·  
Light color infinitely variable
-  4 fach TOUCH ·  
4 level Touch function
-  Akkubetrieb ·  
Rechargeable battery operated

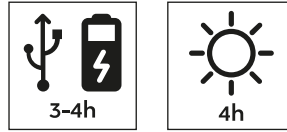

OUTDOOR  
*living*



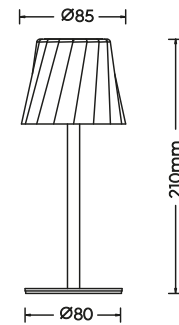

Wandleuchte · Wall lamp  
 incl. SMD-LED  
 1,6 W / 160 Lumen  
 2.700 - 6.500 Kelvin  
**R55961131**  
**R55961132**  
**R55961149**  
**R55961166**  
**R55961177**



# RICARDO

Kunststoff · Plastic ·  
Plastique · Kunststof · Plástico  
Plastica · Plastic · Muovi · Plastik

- 10** | Rot · red
- 31** | Weiß matt · white mat
- 32** | Schwarz matt · black mat
- 49** | Pistaziengrün · pistachio green
- 65** | Coffee · coffee

-  4 fach TOUCH ·  
4 level Touch function
-  USB-C Anschluss ·  
USB-C connection
-  Akkubetrieb ·  
Rechargeable battery operated

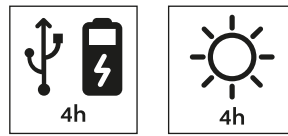

OUTDOOR  
living



Wandleuchte · Wall lamp

incl. SMD-LED  
1,7 W / 240 Lumen  
3.000 Kelvin

R54106110  
R54106131  
R54106132  
R54106149  
R54106165

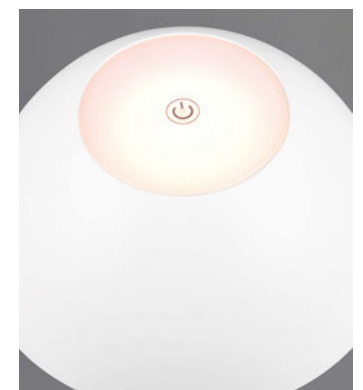
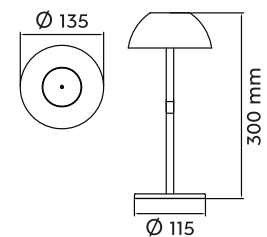

# PALMAS

Kunststoff · Plastic ·  
Plastique · Kunststoff · Plástico ·  
Plastica · Plastic · Muovi · Plastik

01 | Weiß · white

RGBW Farbwechsler ·  
RGBW Colorchanging

Memory Funktion ·  
Memory function

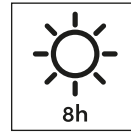
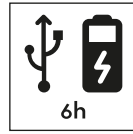

OUTDOOR  
living



Gartenleuchte · Garden lamp  
incl. SMD-LED  
3 W / 90 Lumen  
3.000 Kelvin  
**R45101101**

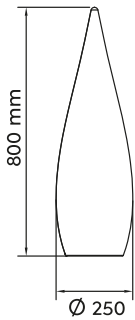

Gartenleuchte · Garden lamp  
incl. SMD-LED  
4,5 W / 120 Lumen  
3.000 Kelvin  
**R45101901**

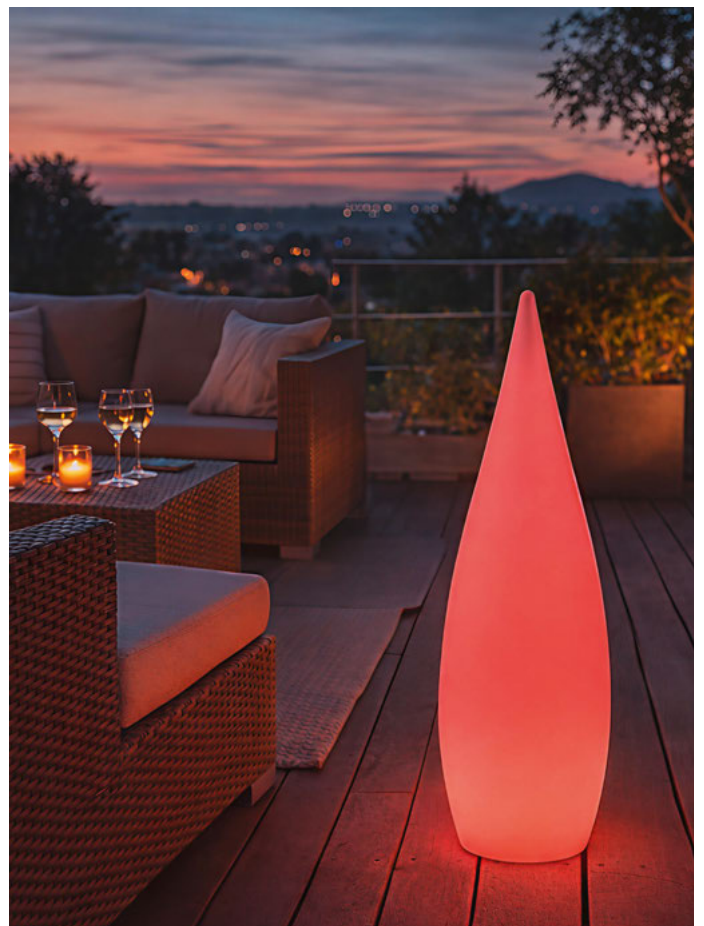
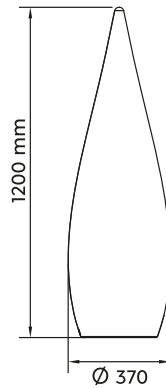



# ARUBA

Kunststoff · Plastic ·  
Plastique · Kunststof · Plástico ·  
Plastica · Plastic · Muovi · Plastik

○ 01 | Weiß · white



RGBW Farbwechsler ·  
RGBW Colorchanging



USB Anschluss ·  
USB connection

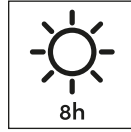
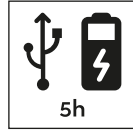

OUTDOOR  
living



Tischleuchte · Table lamp  
incl. SMD-LED  
1 W / 70 Lumen  
3.000 Kelvin  
**R57080101**

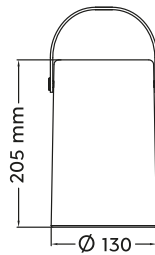

# JAMAICA

Kunststoff · Plastic ·  
Plastique · Kunststoff · Plástico ·  
Plastica · Plastic · Muovi · Plastik

01 | Weiß · white

OUTDOOR  
living

- RGBW Farbwechsler · RGBW Colorchanging
- Bluetooth Lautsprecher · Bluetooth loudspeaker

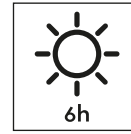
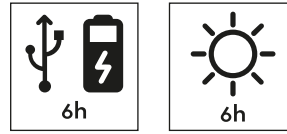

Tischleuchte · Table lamp  
incl. SMD-LED  
2,5 W / 25 Lumen  
3.000 Kelvin  
**R55086101**



IP44

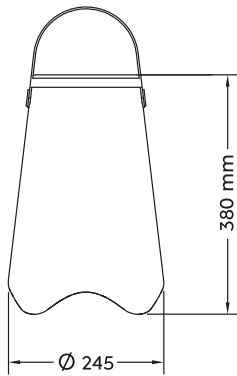

# EMBER

Kunststoff, Hanf naturbelassen · Plastic, hemp natural finish ·  
Plastique, chanvre finition naturelle · Kunststof, Hennep natuurlijke afwerking ·  
Plástico, cáñamo con acabado natural · Plastica, canapa finitura naturale ·  
Plastic, cânepă cu finisaj natural · Muovi, Luonnollinen hamppu · PlastikPlastik, Konopie naturalne

OUTDOOR  
living

02 | Schwarz · black



Lichterkette · Fairy lights  
incl. 8 x SMD-LED  
8 x 0,4 W / 8 x 45 Lumen  
2.700 Kelvin  
R74938602

IP44

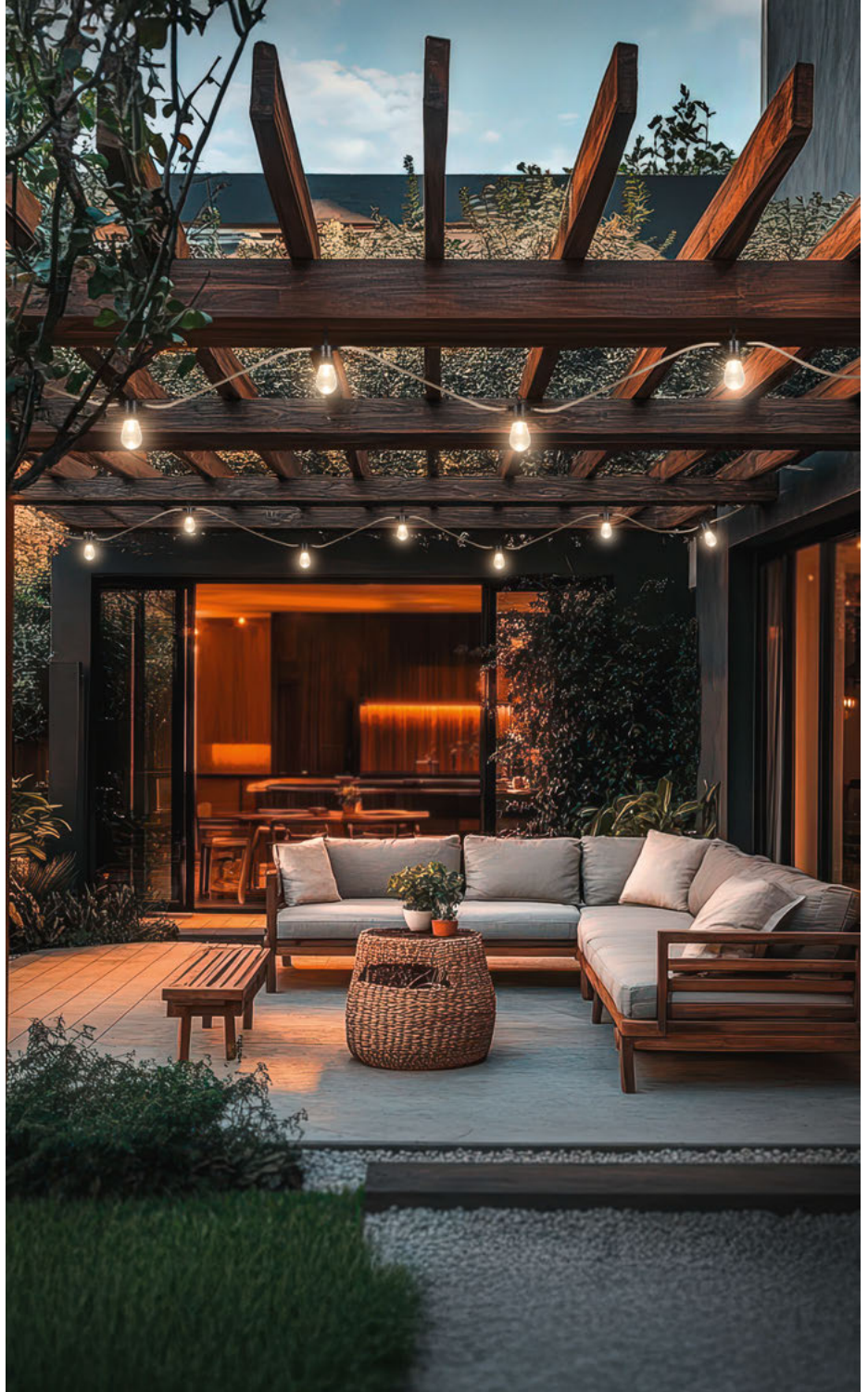
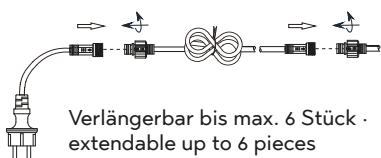

# CHAIN

Kunststoff, Papiergarn naturbelassen · Plastic, paper yarn natural finish ·

Plastique, fil de papier finition naturelle · Kunststof, Papier garen natuurlijke afwerking ·

Plástico, hilo de papel con acabado natural · Plastica, filato di carta finitura naturale ·

Plastic, fir de hârtie cu finisaj natural · Muovi, paperilanka luonnollinen viimeistely · Plastik, przedza papierowa naturalne wykończenie



32 | Schwarz matt · black mat



Lichterkette · Fairy lights

incl. 10 x LED E27

10 x 1 W / 10 x 80 Lumen

3.000 Kelvin

R74771532

IP44

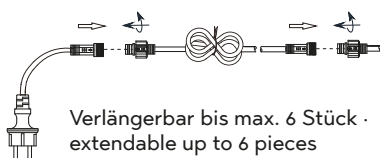
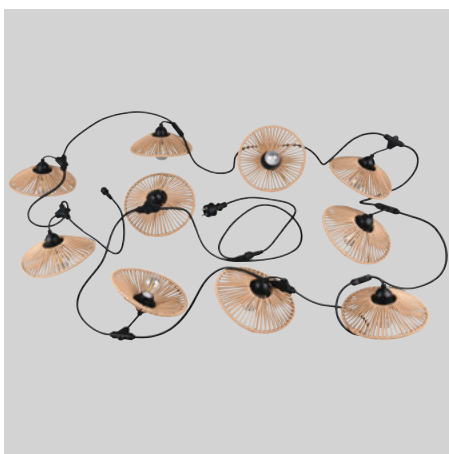
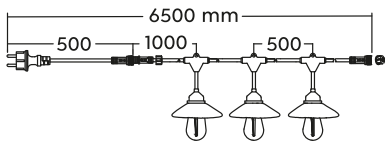

Verlängerbar bis max. 6 Stück ·  
extendable up to 6 pieces



# CHAIN

Kunststoff · Plastic ·  
Plastique · Kunststoff · Plástico ·  
Plastica · Plastic · Muovi · Plastik

OUTDOOR  
living

● 32 | Schwarz matt · black mat



Lichterkette · Fairy lights  
incl. 10 x SMD-LED  
10 x 1 W / 10 x 80 Lumen  
3.000 Kelvin  
**R74771132**

Ⓜ IP44

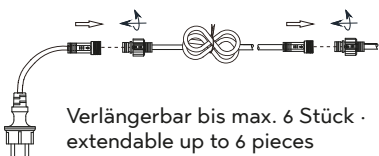
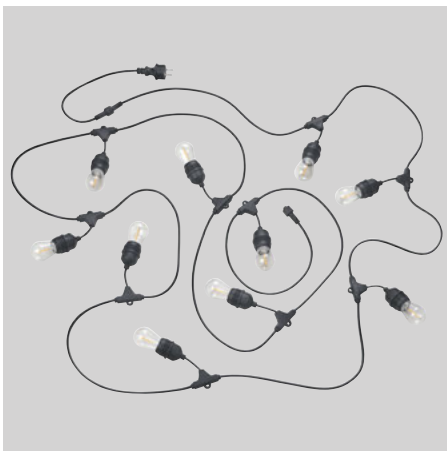
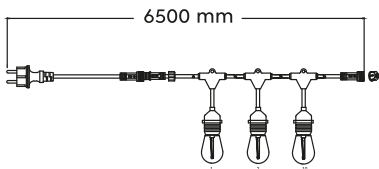

# CHAIN

Metall, Kunststoff · Metal, plastic ·  
Metale, plastique · Metaal, kunststof · Metal, plástico ·  
Metallo, plastica · Metal, plastic · Metalli, muovi · Metal, plastik

OUTDOOR  
living

● 32 | Schwarz matt · black mat



Lichterkette · Fairy lights  
incl. 10 x SMD-LED  
10 x 1 W / 10 x 80 Lumen  
3.000 Kelvin  
R74771932

IP44

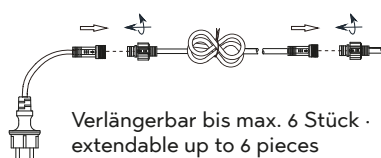
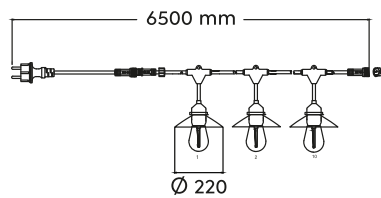

# Produkteigenschaften · Features

Caractéristiques · Kenmerken · Acabados · Caratteristiche · Caracteristici · Ominaisuudet · Cechy



Schalter · Switch  
Interrupteur · Schakelaar · Interruptor ·  
Interruttore · Intrerupator · Kytkin ·  
Przełącznik



Fernbedienung · Remote control  
Commande à distance · Afstandsbediening ·  
Mando a distancia · Comando a distanza ·  
Telecomanda · Kauko-ohjain · Pilot



Integrierter Dimmer · Integrated dimmer  
Variateur intégré · Geïntegreerde dimmer ·  
Regulador integrado · Dimmer integrato ·  
Variator de lumina integrat · Integroitu himmennin ·  
Wbudowany ściemniacz



Sensordimmer · Sensor dimmer  
Variateur tactile · Touchdimmer ·  
Regulador con sensor · Touchdimmer ·  
Variator cu senzor · Kosketushimmennin ·  
Czujnik ściemniania



RGB Farbwechsler · RGB Colorchanging  
Changement de couleur RGB · RGB Kleurverandering ·  
Cambio de color RGB · Cambia colore RGB ·  
Schimbator de culoare RGB · Värinvaihto RGB ·  
Zmieniający kolor RGB



RGBW Farbwechsler · RGBW Colorchanging  
Changement de couleur RGBW · RGBW Kleurverandering ·  
Cambio de color RGBW · Cambia colore RGBW ·  
Schimbator de culoare RGBW · Värinvaihto RGB ·  
Zmieniający kolor RGBW



Lichtfarbe einstellbar · Adjustable light color  
Couleur de lumière réglable · Lichtkleur instelbaar ·  
Color de luz regulable · Colore della luce regolabile ·  
Lumina colorata reglabila · Värilämpötila säädettävissä ·  
Regulowana barwa światła



Lichtfarbe stufenlos einstellbar ·  
Light color infinitely variable  
Couleur de lumière infiniment variable · Lichtkleur  
traploos instelbaar · Color de luz infinitamente variable ·  
Colore della luce infinitamente variabile · Culoare lumină  
infiniit variabilă · Valon väri portaattomasti · Jasny kolor  
bezstopniowo



DIP SWITCH  
Lichtfarben direkt an der Leuchte einstellbar ·  
Colours directly adjustable at the lamp  
Les couleurs de la lumière peuvent être réglées  
directement sur le luminaire · Lichtkleuren direct  
instelbaar op de lamp · Tonalidades de luz ajustables  
directamente en la lámpara · Colori della luce regolabili  
direttamente sulla lampada · Culori ale luminii reglabile  
direct de la bec · Valon väri asetettävissa suoraan  
valaisimesta · Barwy światła można ustawić bezpośrednio  
na oprawie



Schwenkbar · Slewable  
Pivotant · Draaibaar · Pivotante ·  
Girevole · Pivotant · Suunnattava ·  
Skretny



Up and down Beleuchtung · Up and Down lighting  
Point lumineux en haut et en bas · Lichtpunt boven en  
onder · Luz de arriba y abajo · Luce su e giù · Sus și în  
jos lumina · Ylös ja alas valoa · W górę iw dół światło



Steckdose · Plug  
Prise · Stekker · Enchufe · Spina ·  
Priza · Katkaisin · Gniazdko



4 fach TOUCH · 4 level Touch function  
Interrupteur tactile 4 niveaux · Touch schakelaar 4 niveaus ·  
Función Táctil 4 nivel · Interruttore touch 4 livelli ·  
Intrerupator tactil 4 nivele · Kosketuskäyttöinen 4 taso ·  
Funkcja dotykowa 4 poziomy



Kippbar · Tilttable  
Inclinable · Kantelbaar · Basculante ·  
Inclinabile · Basculant · Kallistettava ·  
Uchylny



On/Off Touch Funktion · On/Off Touch function  
Interrupteur tactile On/Off · Touch schakelaar On/Off ·  
Función táctil On/Off · Interruttore touch On/Off ·  
Intrerupator tactil On/Off · Kosketuskäyttöinen On/Off ·  
Funkcja dotykowa On/Off



Ohne Leuchtmittel · Lamp(s) excluded  
Sans ampoule(s) · Zonder lichtbron(nen) ·  
Sin bombilla(s) · Lampadina Esclusa · Fara bec (s) ·  
Ilman polttimo (s) · Bez żarówki (s)



Memory Funktion · Memory function  
fonction mémoire · Geheugen functie ·  
Función de memoria · Funzione memorizzazione ·  
functia memorie · Muistitoiminto · Funkcja pamięci



indirekte Beleuchtung · indirect lighting  
lumière indirecte · indirecte belichting ·  
Iluminación indirecta · Illuminazione a scomparsa ·  
iluminat indirect · epäsuora valaistus ·  
oświetlenie pośrednie



Bewegungssensor · Motion sensor  
Décteur de mouvement · Bewegungssensor ·  
Sensor de movimiento · Sensore di movimento ·  
Senzor de mișcare · Liiketunnistin · Czujnik ruchu



Dämmerungssensor · Dusk sensor  
Décteur de crépuscule · Schemeringsensor ·  
Sensor de oscuridad · Sensore crepuscolare ·  
Senzor de lumina/amurg · Hämärätunnistin ·  
Czujnik zmierzchowy



Helligkeit einstellbar · Adjustable light level  
Niveau d'éclairage ajustable · Instelbaar  
lichtniveau · Nivel de luz ajustable · Livello di luce rego-  
labile · Nivelul de lumina reglabil · Säädettävä valo taso ·  
Regulowana jasność światła



Bluetooth Lautsprecher · Bluetooth loudspeaker  
Haut-parleur bluetooth · Bluetooth luidspreker ·  
Altavoz de bluetooth · Altoparlante bluetooth ·  
Difuzor Bluetooth · Bluetooth-kaiutin ·  
Głośnik Bluetooth



USB Anschluss · USB connection  
Entrée USB · USB aansluiting · Conexión USB ·  
Connessione USB · Conexiune USB · USB-liitäntä ·  
Połączenie USB



USB-C Anschluss · USB-C connection  
Entrée USB-C · USB-C-aansluiting · Conexión USB-C ·  
Connessione USB-C · Conexiune USB-C ·  
USB-C-liitäntä · Połączenie USB-C



Akkubetrieb · Rechargeable battery operated  
Fonctionnement sur batteries rechargeables ·  
Werkt op herlaadbare batterijen · Batería recargable ·  
Batteria Ricaricabile · Operabil prin baterie reîncarcabilă ·  
Ladattava akku · Akumulator zasilany baterijnie



Solar · Solar  
Solaire · Solair · Solar · Solare ·  
Solar · Aurinkokenno · Solar



Timer · Timer  
Minuterie · Timer · Temporizador · Timer ·  
Temporizator · ajastin · Timer



Inklusive Ladestation · Charging station included  
Station de recharge incluse · Laadstation inbegrepen ·  
Estación de carga incluida · Stazione di ricarica inclusa ·  
Stație de încărcare inclusă · Latausasema sisältyy ·  
W zestawie stacja ładowująca



Ladezeit · Charging time  
Temps de charge · Oplaaadtijd · Tiempo de carga ·  
Tempo di carica · Timp de încarcare · Latausaika ·  
Czas ładowania



Leuchtdauer · Luminous period  
Durée d'éclairage · Brandtijd · Tiempo de  
iluminación · Tempo di durata · Perioada de  
iluminare · Valaistus aika · Czas świecenia



Bewegungssensor und Orientierungslicht.

Die Leuchte verfügt über ein Orientierungslicht, das sich bei Dämmerung oder Dunkelheit automatisch einschaltet.  
Wird eine Bewegung erfasst, schaltet die Leuchte von Orientierungslicht auf volle Lichtleistung

Motion sensor and orientation light .

The luminaire has an orientation light that switches on automatically at dusk or in the dark.  
If movement is detected, the luminaire switches from orientation light to full light output.

Capteur de mouvement et lumière d'orientation.

Le luminaire est muni d'une lumière d'orientation qui s'allume automatiquement dès qu'il fait sombre ou dans le noir.  
Si un mouvement est détecté, le luminaire passe de la lumière d'orientation à la lumière maximale.

Bewegingssensor en oriëntatielicht.

Het verlichtingstoestel heeft een oriëntatielicht dat automatisch inschakelt bij schemerdonker of in het donker.  
Wanneer beweging waargenomen wordt, schakelt het verlichtingstoestel over van oriëntatielicht naar volledig  
lichtvermogen.

Lámpara con sensor de movimiento y de orientación.

La lámpara dispone de una luz de orientación que se enciende automáticamente al anoecer o en la oscuridad.  
Si se detecta movimiento, la lámpara pasa de luz de orientación a plena potencia luminosa.

Sensore di movimento e luce di orientamento.

La lampada è dotata di una luce di orientamento che si accende automaticamente al crepuscolo o al buio.  
Se viene rilevato un movimento, la lampada passa dalla luce di orientamento alla piena emissione di luce.

Senzor de mișcare și lumină de orientare.

Corpul de iluminat are o lumină de orientare care se pornește automat în amurg sau în întuneric.  
Dacă este detectată mișcare, corpul de iluminat trece de la lumina de orientare la iluminat deplin.

Liiketunnistin ja suuntavallo.

Valaisimessa on suuntavallo, joka syttyy automaattisesti illansarastuksessa tai pimeään laskiessa.  
Jos liikettä havaitaan, valaisin siirtyy suuntavalosta täyteen valaistustehoon.

Czujnik ruchu i światło orientacyjne.

Oprawa posiada światło orientacyjne, które włącza się automatycznie o zmierzchu lub w ciemności.  
W przypadku wykrycia ruchu oprawa przełącza się ze światła orientacyjnego na pełną moc świetlną.



Abstrahlwinkel · Emission angle  
Angle de rayonnement · Uitstraalhoek ·  
Ángulo de emisión · Angolo di emissione ·  
Unghiul de emisii · Säteilykulma · Kąt emisji



Belastbarkeit · Resilience  
Limite de charge · Belastbaarheid · Resistencia ·  
Resistenza · Rezistența la solicitare ·  
Kuormittavuus · Nośność



Magnetisch · Magnetic  
Magnétique · Magnetisch · Magnético · Magnetic ·  
Magnetic · Magneettinen · Magnetyczny



Mini GU10



Inkl. Hausnummern-Set ·  
incl. set of house numbers  
avec jeu de numéros de maison · incl. set huisnummers ·  
incl. juego de números de casa · incl. set di numeri civici ·  
incl. set de numere de casă · sis. talon numerosarjan ·  
w tym zestaw numerów domów



Stoßfest gemäß IK10 · Shock-resistant according to IK10  
Résistance aux chocs selon IK10 · Slagvast volgens IK10 ·  
Resistente a impactos según IK10 · Resistente agli urti  
secondo IK10 · Rezistent la impact în conformitate cu IK10 ·  
Iskunkestävä IK10:n mukaan · Odporność na uderzenia  
zgodnie z IK10



### Bewegungssensor Multi-Control

Der integrierte Bewegungssensor der Hauptleuchte kann eine bestimmte Anzahl weiterer Leuchten mitsteuern. Die zusätzlichen Leuchten empfangen das Signal der Hauptleuchte und benötigen daher keinen eigenen Sensor.

### Multi-Control motion sensor

The integrated motion sensor of the main light can also control a certain number of additional lights. The additional lights receive the signal from the main light and therefore do not require their own sensor.

### Capteur de mouvement Multi-Control

Le capteur de mouvement intégré du luminaire principal peut également commander un certain nombre de luminaires supplémentaires. Les luminaires supplémentaires reçoivent le signal du luminaire principal et n'ont donc pas besoin de leur propre capteur.

### Multi-Control bewegingssensor

De geïntegreerde bewegingssensor van de hoofdlamp kan ook een bepaald aantal extra lampen aansturen. De extra lampen ontvangen het signaal van de hoofdlamp en hebben dus geen eigen sensor nodig.

### Sensor de movimiento Multi-Control

El sensor de movimiento integrado de la luz principal también puede controlar un cierto número de luces adicionales. Las luces adicionales reciben la señal de la luz principal y, por tanto, no necesitan su propio sensor.

### Sensore di movimento Multi-Control

Il sensore di movimento integrato nella luce principale può controllare anche un certo numero di luci aggiuntive. Le luci supplementari ricevono il segnale dalla luce principale e non necessitano quindi di un proprio sensore.

### Senzor de mișcare Multi-Control

Senzorul de mișcare integrat al luminii principale poate controla, de asemenea, un anumit număr de lumini suplimentare. Luminile suplimentare primesc semnalul de la lumina principală și, prin urmare, nu au nevoie de un senzor propriu.

### Multi-Control liiketunnistin

Päävalon integroitu liiketunnistin voi ohjata myös tiettyä määrää lisävaloja. Lisävalot saavat signaalin päävalosta, joten ne eivät tarvitse omaa tunnistinta.

### Czujnik ruchu Multi-Control

Zintegrowany czujnik ruchu głównego światła może również sterować pewną liczbą dodatkowych światel. Dodatkowe światła odbierają sygnał z głównego światła i dlatego nie wymagają własnego czujnika.



### Inkl. Verbinder für Reihenschaltung

Der Anschlusskasten dieser Leuchten ist so ausgelegt, dass er zwei Anschlussleitungen aufnehmen kann. Dadurch lassen sich mehrere Leuchten problemlos in Reihe schalten.

### Connector for series connection included

The connection box of these lights is designed to accommodate two connection cables. This means that several lights can be easily connected in series.

### Connecteur pour connexion en série inclus

Le boîtier de raccordement de ces luminaires est conçu de manière à pouvoir accueillir deux câbles de raccordement. Il est ainsi possible de brancher plusieurs luminaires en série sans problème.

### Connector voor serieaansluiting inbegrepen

De aansluitdoos van deze lampen is zo ontworpen dat er twee aansluitkabels in passen. Dit betekent dat meerdere lampen eenvoudig in serie kunnen worden aangesloten.

### Conector para conexión en serie incluido

La caja de conexiones de estas luces está diseñada para alojar dos cables de conexión. Esto permite conectar fácilmente varias luces en serie.

### Connettore per il collegamento in serie incluso

La scatola di connessione di queste luci è progettata per ospitare due cavi di collegamento. In questo modo è possibile collegare facilmente più luci in serie.

### Conector pentru conectare în serie inclus

Cuția de conexiuni a acestor lumini este proiectată pentru a găzdui două cabluri de conexiune. Acest lucru înseamnă că mai multe lumini pot fi conectate cu ușurință în serie.

### Mukana liitin sarjakytkentää varten

Näiden valaisimien liitäntäkotelot on suunniteltu siten, että siihen mahtuu kaksi liitäntäkäpeliä. Tämä tarkoittaa, että useita valoja voidaan helposti kytkeä sarjaan.

### W zestawie złącze do połączenia szeregowego

Skrzynka połączeniowa tych światel została zaprojektowana tak, aby pomieścić dwa kable połączeniowe. Oznacza to, że kilka lamp można łatwo połączyć szeregowo.



### Geeignet für Küstengebiete 10 Jahre

10 Jahre Garantie auf Korrosionsschutz bei Leuchten aus pulverbeschichtetem Aluminium. Ausgenommen sind Ausbleichen der Oberfläche sowie technische Komponenten.

### Seaside ready (10 years)

10-year guarantee on corrosion protection for luminaires made of powder-coated aluminum. This excludes fading of the surface and technical components.

### Seaside ready (10 ans)

10 ans de garantie contre la corrosion pour les luminaires en aluminium thermolaqué. Sont exclus la décoloration de la surface ainsi que les composants techniques.

### Klaar voor de kust (10 jaar)

10 jaar garantie op corrosiebescherming voor armaturen gemaakt van gepoedercoat aluminium. Dit sluit verbleking van het oppervlak en technische onderdelen uit.

### Seaside ready (10 años)

10 años de garantía de protección contra la corrosión para luminarias de aluminio con recubrimiento de polvo. Esto excluye la decoloración de la superficie y los componentes técnicos.

### Seaside ready (10 anni)

Garanzia di 10 anni sulla protezione dalla corrosione per gli apparecchi di illuminazione in alluminio verniciato a polvere. Questo esclude lo sbiadimento della superficie e dei componenti tecnici.

### Seaside ready (10 ani)

Garanție de 10 ani privind protecția împotriva coroziunii pentru corpurile de iluminat din aluminiu acoperit cu pulbere. Aceasta exclude decolorarea suprafeței și a componentelor tehnice.

### Seaside ready (10 vuotta)

10 vuoden korroosiosuojatarkkuu jauhemaalasta alumiinista valmistetuille valaisimille. Tämä ei koske pinnan ja teknisten osien haalistumista.

### Seaside ready (10 lat)

10-letnia gwarancja na ochronę antykorozyjną opraw oświetleniowych wykonanych z aluminium malowanego proszkowo. Nie obejmuje to blaknięcia powierzchni i elementów technicznych.



### Geeignet für Küstengebiete 15 Jahre

15 Jahre Garantie auf Korrosionsschutz bei Leuchten aus feuerverzinktem Edelstahl. Ausgenommen sind Ausbleichen der Oberfläche sowie technische Komponenten.

### Seaside ready (15 years)

15-year guarantee on corrosion protection for luminaires made of hot-dip galvanized stainless steel. This excludes fading of the surface and technical components.

### Seaside ready (15 ans)

15 ans de garantie contre la corrosion pour les luminaires en acier inoxydable galvanisé à chaud. Sont exclus la décoloration de la surface ainsi que les composants techniques.

### Klaar voor de kust (15 jaar)

15 jaar garantie op corrosiebescherming voor armaturen gemaakt van thermisch verzinkt roestvrij staal. Dit sluit verbleking van het oppervlak en technische onderdelen uit.

### Seaside ready (15 años)

15 años de garantía de protección contra la corrosión para luminarias de acero inoxidable galvanizado en caliente. Esto excluye la decoloración de la superficie y los componentes técnicos.

### Seaside ready (15 anni)

Garanzia di 15 anni sulla protezione dalla corrosione per gli apparecchi di illuminazione in acciaio inox zincato a caldo. Questo esclude lo sbiadimento della superficie e dei componenti tecnici.

### Seaside ready (15 ani)

Garanție de 15 ani privind protecția împotriva coroziunii pentru corpurile de iluminat din oțel inoxidabil galvanizat la cald. Aceasta exclude decolorarea suprafeței și a componentelor tehnice.

### Seaside ready (15 vuotta)

15 vuoden korroosiosuojatarkkuu kuumasinkitystä ruostumattomasta teräksestä valmistetuille valaisimille. Tämä ei koske pinnan ja teknisten osien haalistumista.

### Seaside ready (15 lat)

15-letnia gwarancja na ochronę antykorozyjną opraw oświetleniowych wykonanych ze stali nierdzewnej ocynkowanej ognioowo. Nie obejmuje to blaknięcia powierzchni i elementów technicznych.



### D Schutzklasse 1

Leuchten für den Anschluss an den netzseitigen Schutzleiter.  
Das Symbol ist an der Anschlussstelle angebracht.

#### GB Protection grade I:

Lamps for connection to network safety conductors.  
The symbol is placed at the connection port.

#### FR Degré de protection I:

Les lampes qui ont une connexion avec la prise de terre.  
Les lampes qui ont une connexion avec la prise de terre.

#### NL Beschermlasse I:

Lampen voor aansluiting op de netzijdige  
veiligheidsaarddraad.  
Het symbool is op het aansluitpunt aangebracht.

#### ES Protección tipo I:

Lámparas para conectar en redes de conductores seguros.  
El símbolo está indicado en el conector.

#### IT Classe di protezione I:

Apparecchi con parti metalliche costantemente  
collegate al circuito di terra. Il simbolo è riportato sul  
punto di collegamento.

#### RO Protectie grad I:

Lampile care au conectare cu priza de pamant.  
Simbolul este plasat la punctul de conectare.

#### FI Suojausluokka I:

Valaisimet, jotka liitetään verkon turvamaadoitukseen.  
Symboli on merkitty liitântäkohtaan.

#### PL Klasa ochrony I:

Oprawy przystosowane do podłączenia przewodu  
ochronnego. Oznakowanie znajduje się w miejscu  
podłączenia.



### D Schutzklasse 2

Leuchten für den Betrieb mit Schutzkleinspannung.

#### GB Protection grade II:

Protected low voltage lamps.

#### FR Degré de protection II:

Les lampes protégées à faible voltage.

#### NL Beschermlasse II:

Lampen voor het gebruik met veiligheidslaagspanning.

#### ES Protección tipo II:

Lámparas de bajo voltaje con protección.

#### IT Classe di protezione II:

Apparecchi alimentati con tensione di sicurezza  
inferiore ai 50 V.

#### RO Protectie grad II:

Lampi protejate la tensiune joasa.

#### FI Suojausluokka II:

Valaisimet, joita käytetään suojapienjännitteellä.

#### PL Klasa ochrony II:

Oprawy przeznaczone do zasilania z sieci o  
niskim napięciu bezpiecznym.



### D Schutzklasse 3

Leuchten mit einer zusätzlichen oder verstärkten  
Isolierung. Sie haben keinen Schutzleiteranschluss.

#### GB Protection grade III:

Lamps with additional or reinforced insulation.  
There is no connection for the safety conductor.

#### FR Degré de protection III:

Les lampes ayant une isolation supplémentaire ou  
renforcée. Il n'y a pas de connexion pour le  
conducteur de protection.

#### NL Beschermlasse III:

Lampen met een extra of versterkte isolatie.  
Ze hebben geen veiligheidsaarddraadaansluiting.

#### ES Protección tipo III:

Lámparas con aislamiento adicional o reforzado.  
No tiene conexión con el conductor de seguridad.

#### IT Classe di protezione III:

Apparecchi con parti in tensione isolate fra loro e  
verso l'esterno con un doppio isolamento e senza  
dispositivi di messa a terra.

#### RO Protectie grad III:

Lampi care au o izolatie suplimentara sau ranforsata.  
Nu exista o conexiune pentru conductorul de siguranta.

#### FI Suojausluokka III:

Valaisimet, joissa on lisäeristys tai vahvistettu eristys.  
Niissä ei ole turvamaadoitusliitântää.

#### PL Klasa ochrony III:

Oprawy przystosowane do podłączenia przewodu  
ochronnego. Oznakowanie znajduje się w miejscu  
podłączenia.

## Farben & Materialien · Colours and materials

Couleurs et matériaux · Kleuren en materialen · Colores y materiales · Colori e materiali ·  
Culori si materiale · Värit ja materiaalit · Kolory i materiały

### 01 Weiß · white

blanc · wit · blanco · bianco · alb · valkoinen · biały

### 02 Schwarz · black

noir · zwart · negro · nero · negru · musta · czarny

### 07 Nickel matt · nickel mat

nickel mat · nikkel mat · níquel mate · nichel opaco ·  
nichel mat · harjattu teräs · nikiel mat

### 10 Rot · red

rouge · rood · rojo · rosso · rosu ·  
punainen · czerwony

### 11 Grau · grey

gris · grijs · gris · grigio · gri · harmaa · popielaty

### 15 Grün · green

vert · groen · verde · verde · verde · vihreä · zielony

### 24 rostfarbig · rusty

rouille · roestkleur · óxido · ruggine · ruginiu ·  
rustiikki · miedź

### 28 rostfarbig antik · antique rust

rouille antique · roestkleur antiek · oxido · ruggine anticato ·  
ruginiu antic · rustiikki · antyczny rdzawy

### 31 Weiß matt · white mat

blanc mat · wit mat · estera blanca · bianco opaco ·  
alb mat · valkoinen matto · biały mat

### 32 Schwarz matt · black mat

noir mat · mat zwart · estera negra · nero opaco ·  
negru mat · musta matto · czarny mat

### 35 Holznachbildung · wood imitation

imitation bois · houtimitatie · imitación de madera ·  
effetto legno · imitație de lemn · puujäljitelmä ·  
imitacja drewna

### 40 Apricot · apricot

abricot · abrikoos · albaricoque · apricot ·  
caise · aprikoosi · morela

### 42 Anthrazit · anthracite

antracite · antraciet · antracita · antracite · antracit ·  
antrasiitti · antracyt

### 49 Pistaziengrün · pistachio green

vert pistache · pistachegroen · verde pistacho ·  
verde pistacchio · verde fistic · pistaasin vihreä ·  
zielony pistacjowy

### 65 Coffee · coffee

café · koffie · café · caffè · cafea · antiikkiteräs · kawa

### 66 Sand · sable

zand · arena · sabbia · nisip · hiekka · piaskowy · kum

### 77 Ultimate Grau · ultimate grey

gris ultimate · ulziem grijs · gris absoluto ·  
grigio assoluto · gri suprem · ultimaattinen harmaa ·  
ciemnoszary

### 83 Illuminate Gelb · illuminate yellow

jaune illuminate · helder geel · amarillo iluminado ·  
giallo brillante · galben strălucitor · hehkuvan keltainen ·  
swietlisty żółty

### 86 zinkfarbig · zinc-colored

couleur zinc · zink kleur · color zinc · color Zinco ·  
culoarea zincului · antiikkiihopea · kolor cynkowy

Seite Page	Artikel-Nr. Product No.	EAN-Nummer EAN-Number	Seite Page	Artikel-Nr. Product No.	EAN-Nummer EAN-Number
102	201760124	4017807442021	82	222260124	4017807410594
102	201760131	4017807687354	85	222260132	4017807603620
102	201760142	4017807445411	78	222260142	4017807382570
96	201860124	4017807687378	82	222260224	4017807410587
96	201860131	4017807647525	85	222260232	4017807603637
96	201860142	4017807433210	78	222260242	4017807382587
96	201860224	4017807687392	84	224060132	4017807603583
96	201860231	4017807647549	80	224060142	4017807434330
96	201860242	4017807442410	84	224060232	4017807603590
95	201869142	4017807603378	80	224060242	4017807434347
112	201960124	4017807442045	24	226260142	4017807492545
112	201960142	4017807442052	34	226360142	4017807492347
113	202360124	4017807449891	34	226369142	4017807492354
113	202360142	4017807442069	41	226460242	4017807415612
114	202760124	4017807445589	52	226560242	4017807408539
114	202760142	4017807449884	42	226660242	4017807388893
92	204160124	4017807413939	42	226669242	4017807388817
94	204160131	4017807492408	40	226860242	4017807382839
94	204160135	4017807647587	43	226960231	4017807382259
90	204160142	4017807413946	43	226960242	4017807382266
93	204169124	4017807492446	49	227260142	4017807369236
94	204169131	4017807492422	48	227360142	4017807369229
94	204169135	4017807647600	41	227560231	4017807337570
91	204169142	4017807492460	41	227560242	4017807337594
58	204260224	4017807519006	41	227660231	4017807337600
58	204260231	4017807518986	41	227660242	4017807337617
58	204260242	4017807453171	48	228060142	4017807281569
58	204269224	4017807519044	45	228260142	4017807279535
58	204269231	4017807519020	52	228460242	4017807284164
58	204269242	4017807453195	45	228560242	4017807356984
108	205760131	4017807693690	44	228669142	4017807356656
108	205760132	4017807543407	53	229160142	4017807242126
108	205767131	4017807693683	40	229360242	4017807242164
108	205767132	4017807543414	22	230561142	4017807648522
104	205960128	4017807543575	23	230569142	4017807648539
104	205967128	4017807543582	20	238560142	4017807686807
54	206060142	4017807490480	20	238569142	4017807686821
106	206960132	4017807543810	14	238660142	4017807686876
106	206967132	4017807543803	14	238669142	4017807686890
102	207269124	4017807492613	12	240960142	4017807563993
70	207360142	4017807492675	12	240969142	4017807564006
64	209760107	4017807556551	38	245560142	4017807603392
64	209760132	4017807648201	38	245569142	4017807603408
64	209769107	4017807693744	29	246360142	4017807603484
64	209769132	4017807648218	29	246360242	4017807603491
88	211060142	4017807506174	29	246360342	4017807603507
88	211069142	4017807506198	35	246860142	4017807603569
66	211660132	4017807564075	35	246869142	4017807603576
68	211660135	4017807603439	18	246960135	4017807603705
114	212060142	4017807529272	18	246969135	4017807603712
114	212069142	4017807529289	16	247060142	4017807603767
44	212160242	4017807529340	17	247069142	4017807603774
53	212560232	4017807564044	28	247360242	4017807603798
56	214260142	4017807529210	146	253569142	4017807622478
56	214260242	4017807529234	148	253769142	4017807622508
56	214269142	4017807529227	50	260260224	4017807691320
56	214269242	4017807529241	50	260260231	4017807691344
103	218260124	4017807691276	50	260260242	4017807691306
103	218260142	4017807691177	55	260360131	4017807691566
43	218560231	4017807647563	55	260360142	4017807691412
43	218560235	4017807603477	100	260560186	4017807691719
43	218560242	4017807603460	100	260660286	4017807691887
32	220760142	4017807259063	101	261060186	4017807691672
42	220969142	4017807259315	98	262060186	4017807687675
30	221160142	4017807302004	98	262067186	4017807687699
31	221169142	4017807279290	115	262260124	4017807648287
39	221460142	4017807490473	115	262260131	4017807648294
39	221460242	4017807564037	115	262260142	4017807648270

Seite Page	Artikel-Nr. Product No.	EAN-Nummer EAN-Number	Seite Page	Artikel-Nr. Product No.	EAN-Nummer EAN-Number
61	262360115	4017807648454	81	424067142	4017807445404
61	262360124	4017807648430	24	426260142	4017807492576
61	262360140	4017807648461	22	430561142	4017807648553
61	262360142	4017807648423	20	438560142	4017807686852
61	262360166	4017807648447	20	438569142	4017807686869
60	262460115	4017807648508	14	438660142	4017807686920
60	262460124	4017807648485	14	438669142	4017807686937
60	262460140	4017807648515	12	440969142	4017807564020
60	262460142	4017807648478	18	446960135	4017807603736
60	262460166	4017807648492	16	447060142	4017807603750
74	262560135	4017807648560	146	453569142	4017807622492
72	262560178	4017807650235	149	453769142	4017807622522
74	262569135	4017807648577	55	460360131	4017807691634
72	262569178	4017807650242	55	460360142	4017807691450
110	263260131	4017807648119	98	462060186	4017807687736
110	263260132	4017807648102	74	462560135	4017807648591
110	263260231	4017807648133	72	462560178	4017807650266
110	263260232	4017807648126	62	469460142	4017807687064
111	263260331	4017807648195	76	469860142	4017807687309
111	263260332	4017807648188	76	469869142	4017807687323
62	269460142	4017807686944	26	477860142	4017807564112
62	269460242	4017807686982	97	501860142	4017807433234
62	269469142	4017807690965	92	504160124	4017807413977
51	269560131	4017807687125	90	504160142	4017807413991
51	269560142	4017807687101	58	504260142	4017807453218
51	269560231	4017807687163	108	505760131	4017807693720
51	269560242	4017807687149	108	505760132	4017807543421
50	269760224	4017807687477	104	505960128	4017807543599
50	269760231	4017807687453	54	506060142	4017807490497
50	269760242	4017807687439	106	506960132	4017807543827
76	269860142	4017807687187	70	507360142	4017807492705
76	269869142	4017807687200	64	509760107	4017807556575
36	270660142	4017807529111	64	509760132	4017807648225
36	270660242	4017807529159	66	511660132	4017807564082
37	270669142	4017807529135	68	511660135	4017807603446
37	270669242	4017807529166	56	514260142	4017807529258
26	277860142	4017807529333	86	520060142	4017807241563
111	363260131	4017807648171	32	520760142	4017807259100
111	363260132	4017807648164	30	521160142	4017807351590
97	401860142	4017807433258	31	521169142	4017807279313
95	401869142	4017807603385	82	522260124	4017807410563
92	404160124	4017807413953	78	522260142	4017807382594
90	404160142	4017807413960	84	524060132	4017807603606
92	404160324	4017807648317	80	524060142	4017807434354
90	404160342	4017807648300	24	526260142	4017807492569
58	404260142	4017807453232	22	530561142	4017807648546
108	405760132	4017807543445	20	538560142	4017807686838
108	405760332	4017807543452	20	538569142	4017807686845
104	405960128	4017807543605	14	538660142	4017807686906
104	405960328	4017807543612	14	538669142	4017807686913
106	406960132	4017807543834	12	540969142	4017807564013
106	406960332	4017807543841	18	546960135	4017807603729
70	407360142	4017807492729	16	547060142	4017807603743
64	409760107	4017807556599	146	553569142	4017807622485
64	409760132	4017807687415	149	553769142	4017807622515
88	411060142	4017807506211	55	560360131	4017807691597
88	411060342	4017807506228	55	560360142	4017807691436
66	411660132	4017807564099	98	562060186	4017807687712
68	411660135	4017807603453	74	562560135	4017807648584
56	414260142	4017807529265	72	562560178	4017807650259
86	420060142	4017807241792	110	563260131	4017807648157
32	420760142	4017807259087	110	563260132	4017807648140
30	421160142	4017807351583	62	569460142	4017807687026
31	421169142	4017807279306	76	569860142	4017807687262
82	422260124	4017807410570	76	569869142	4017807687286
78	422260142	4017807382600	26	577860142	4017807564105
84	424060132	4017807603613	96	601860242	4017807442397
80	424060142	4017807434361	46	630369142	4017807648348

Seite Page	Artikel-Nr. Product No.	EAN-Nummer EAN-Number	Seite Page	Artikel-Nr. Product No.	EAN-Nummer EAN-Number
46	630369242	4017807648355	126	R28222631	4017807408324
47	676960142	4017807453416	126	R28222632	4017807411775
26	677860142	4017807529326	127	R28232631	4017807408317
117	800260142	4017807453133	127	R28232632	4017807411768
117	800260342	4017807453157	176	R35146132	4017807529432
116	821660107	4017807453287	164	R42251142	4017807452709
116	821660207	4017807453348	164	R42261142	4017807452730
119	9960-07	4017807259360	150	R43286132	4017807648003
118	9962-11	4017807305784	122	R43356142	4017807648409
118	9964-42	4017807445299	152	R44676132	4017807622430
119	9965-32	4017807472349	186	R45101101	4017807500295
134	R21186131	4017807564136	186	R45101901	4017807500301
134	R21186132	4017807564129	140	R45853632	4017807697575
138	R21596124	4017807603828	140	R45863632	4017807697599
138	R21596131	4017807603804	180	R47706131	4017807601749
138	R21596132	4017807603811	180	R47706132	4017807601756
128	R22052142	4017807490428	180	R47706149	4017807601763
128	R22062142	4017807490435	180	R47706166	4017807643220
166	R22106132	4017807650488	183	R52176101	4017807496314
166	R22109132	4017807650495	183	R52176102	4017807496338
136	R22151142	4017807453546	183	R52176149	4017807541236
169	R22189132	4017807650563	183	R52176183	4017807541229
167	R22231107	4017807458220	150	R53286132	4017807647990
167	R22231142	4017807452648	122	R53356142	4017807648416
164	R22251142	4017807452686	182	R54096131	4017807564327
164	R22261142	4017807452723	182	R54096132	4017807564334
167	R22281142	4017807452754	182	R54096631	4017807601671
130	R23056142	4017807647907	182	R54096632	4017807601688
130	R23056242	4017807647914	182	R54099602	4017807610376
168	R23066101	4017807647921	185	R54106110	4017807601817
168	R23146101	4017807647938	185	R54106131	4017807601787
162	R23156102	4017807647945	185	R54106132	4017807601794
162	R23166101	4017807647952	185	R54106149	4017807601800
163	R23176102	4017807647969	185	R54106165	4017807633900
150	R23286132	4017807647983	152	R54676132	4017807622423
154	R23306101	4017807648027	189	R55086101	4017807444421
154	R23306102	4017807648010	172	R55326101	4017807492101
158	R23326102	4017807648034	172	R55326901	4017807492125
155	R23336201	4017807648041	184	R55961131	4017807644777
155	R23336202	4017807648058	184	R55961132	4017807644784
132	R23346132	4017807648065	184	R55961149	4017807644807
132	R23346232	4017807648072	184	R55961166	4017807644791
132	R23349132	4017807648089	184	R55961177	4017807644814
132	R23349232	4017807648096	142	R57042001	4017807282801
122	R23356142	4017807648386	142	R57043001	4017807282818
122	R23359142	4017807648393	142	R57044001	4017807282825
152	R24676132	4017807622416	188	R57080101	4017807407556
159	R24696132	4017807622539	180	R57706131	4017807601701
156	R24706132	4017807622546	180	R57706132	4017807601718
157	R24716132	4017807622553	180	R57706149	4017807601725
158	R24746232	4017807622577	180	R57706166	4017807643244
171	R25119631	4017807691610	136	R60501031	4017807405873
171	R25119632	4017807691658	136	R60501042	4017807405910
170	R25129631	4017807691528	136	R62151142	4017807405989
170	R25129632	4017807691542	176	R74761132	4017807622607
131	R26446232	4017807648232	177	R74761932	4017807650693
135	R26456132	4017807648249	192	R74771132	4017807622720
135	R26459132	4017807648256	191	R74771532	4017807697612
139	R26476124	4017807648331	193	R74771932	4017807650648
139	R26476142	4017807648324	190	R74938602	4017807687767
131	R26931631	4017807691474	174	R83256332	4017807647976
131	R26931632	4017807691498	175	R84756232	4017807622584
125	R26961632	4017807687507	143	R86466102	4017807648263
125	R26962632	4017807687521	143	R86871042	4017807687910
124	R26971631	4017807687552			
124	R26971632	4017807687576			
129	R27026132	4017807529357			
129	R27036132	4017807529364			

## TRIO Leuchten GmbH

Gut Nierhof 17  
D-59757 Arnsberg  
T +49 (0) 2931 9666-0  
F +49 (0) 2931 9666-57  
info@trio-leuchten.de  
www.trio-leuchten.de

## Reality Leuchten GmbH

Gut Nierhof 17  
D-59757 Arnsberg  
T +49 (0) 2931 9666-99  
F +49 (0) 2931 9666-98  
info@reality-leuchten.de  
www.reality-leuchten.de

## TRIO International GmbH

Gut Nierhof 17  
D-59757 Arnsberg  
T +49 (0) 2931 9666-587  
F +49 (0) 2931 9666-56  
info@trio-lighting.com  
www.trio-lighting.com

## Baden Württemberg, Rheinland-Pfalz, Saarland

**Antonio De Simone**  
T +49 (0) 151 5855222  
antonio.desimone@trio-leuchten.de

## Bayern, Hessen

**Martin Kluge**  
T +49 (0) 171 7300330  
martin.kluge@trio-leuchten.de

## Berlin, Brandenburg, Mecklenburg-Vorpommern, Sachsen, Sachsen-Anhalt, Thüringen

**Jörg Bumke**  
T +49 (0) 160 7406860  
joerg.bumke@trio-leuchten.de

## Bremen, Hamburg, Niedersachsen, Schleswig-Holstein

**Jens Gebers**  
T +49 (0) 170 1615227  
jens.gebers@trio-leuchten.de

## Hessen, Nordrhein-Westfalen, Rheinland-Pfalz

**Christian Teller**  
T +49 (0) 171 4521820  
christian.teller@trio-leuchten.de

## Österreich

**Wolfgang Melich**  
T +43 (0) 660 5161228  
wolfgang.melich@trio-leuchten.de

## Schweiz

**TRIO Leuchten GmbH**  
T +49 (0) 2931 9666-0  
info@trio-leuchten.de



## France

**Stéphane Papierny**  
Directeur commercial France  
T +33 9 74 77 07 90  
info.france@trio-lighting.com

**Maïté Jourdan Casu**  
Chef des Ventes et Responsable  
Comptes clés - France

**Sullivan Nicolas**  
Commercial pour les départements  
01, 03, 07, 21, 23, 26, 38, 39, 42, 43, 48, 63,  
69, 71, 73 et 74

**Vincent Zaeppfel**  
Commercial pour les départements  
08, 10, 25, 51, 52, 54, 55, 57, 67, 68, 70,  
88 et 90

**Christophe Meulien**  
Agent commercial pour les départements  
04, 05, 06, 11, 13, 30, 34, 66, 83, 84 et 98

**Jean Barel**  
Agent commercial pour les départements  
09, 12, 15, 16, 19, 24, 31, 32, 33, 40, 46, 47,  
64, 65, 81, 82 et 87

**Stéphane Kerjean**  
Agent commercial pour les départements  
14, 17, 22, 29, 35, 36, 37, 41, 44, 49, 50, 53, 56,  
61, 72, 79, 85 et 86

**Stéphane Riebel**  
Agent commercial pour les départements  
18, 27, 28, 45, 58, 75, 76, 77, 78, 89, 91, 92, 93,  
94 et 95

**Sylvain Martin**  
Agent commercial pour les territoires  
des DROM-COM

**Agence Rouquié**  
**Bruno Rouquié**  
Agent commercial GSB pour les départements  
09, 12, 15, 16, 17, 18, 19, 24, 31, 32, 33, 36, 40, 46,  
47, 64, 65, 81, 82 et 87

**Jean Marc Beneforti**  
Agent commercial pour les départements  
2a et 2b

**Daho Bekhti**  
Agent commercial pour les départements  
02, 59, 60, 62 et 80

**Agence Nao West**  
**Aymeric Monnet / Marie Lafleuriel**  
Agent commercial GSB pour les départements  
14, 22, 29, 35, 37, 41, 44, 49, 50, 53, 56, 61, 72,  
79, 85 et 86

## Belgium / Luxemburg

**Yves Van den Berghe / Frank Boesmans /  
Pauline Delorme / Wim Deplae**  
info.belgium@trio-lighting.com

## Denmark

**Jan Rantzau-Bartens**  
info.denmark@trio-lighting.com

## Netherlands

**Karl Stok / Bas Martin**  
info.nederland@trio-lighting.com

## Romania

**Loredana Barbu**  
T (+40) 741 788 674  
loredana.barbu@trio-lighting.com

## Great Britain

**TRIO Lighting UK Ltd.**  
KC 28/29 Knowledge Centre  
Wyboston Lakes Resort  
Great North Road  
Wyboston  
Bedfordshire  
MK44 3AL  
T +44 (0) 1268 889 595  
F +44 (0) 1268 889 596  
sales-uk@trio-lighting.com

## Italy

**TRIO Lighting Italia s.r.l**  
Via Isonzo, 81  
22066 Mariano Comense (CO)  
T +39 (0) 317 477 55  
F +39 (0) 313 551 560  
commerciale@trio-lighting.com

## Nordic and Baltic

**TRIO Lighting Scandinavia Oy**  
Malmin raitti 17, rappu B  
00700 Helsinki  
T +358 (0) 10 23 13 390  
TLS@trio-lighting.com

*Our Scandinavian organisation represents TRIO  
in Finland, Sweden, Norway, Iceland, Estonia,  
Latvia and Lithuania.*

## Spain

**TRIO Lighting Ibèrica S.L.**  
C/VALLESPIR 19, Plta 2, módulo 1.1  
08173 Sant Cugat del Vallès  
T +34 (0) 935 458 630  
info.iberica@trio-lighting.com

## Africa

**F&M Global**  
T (+32) 4719 22111  
hans.deserranno@fmglobal.be

**Ina Concept**  
T (+32) 4719 94693  
jerome.freri@ina-concept.com

## Albania

**Kika Light**  
T (+355) 672 084 781  
kikallight@gmail.com

## Bosnia and Herzegovina

**GRIČ d.o.o.**  
T (+38) 7039 706 658  
daniel.martinovic@tel.net.ba

## Bulgaria

**ATG Bulgaria**  
T (+359) 899 927 707  
deyana\_petrova@atg-apa.net

## Czech Republic

**Luminex spol. s.r.o.**  
T (+42) 777 570 560  
objednavky@luminex.cz

## Greece / Cyprus

**Solomon Lighting S.A.**  
T (+30) 21060 46003  
alberto@solomongroup.gr

## Hungary

**Luxera Kft.**  
T (+36) 83 3163 88  
info@trio-lampa.hu

## Kosovo

**ACN**  
T (+383) 44 344 434  
info@acn-ks.com

## North Macedonia

**Elektro Megavat**  
T (+389) 71665006  
contact@megalight.com.mk

## Poland

**Delighting Polska sp. z.o.o.**  
T (+48) 61 4367 481  
kontakt@delighting.pl

## Republic of Moldova

**Volta LTD**  
T (+37) 322 26 7775  
import5@volta.md

## Serbia

**Aura Light d.o.o. Novi Sad**  
T (+38) 121 2100724  
aura.lightdoo@gmail.com

## Slovakia

**Feim SK s.r.o.**  
T (+42) 134 7743 228  
svietidla@feim.sk

## Slovenia

**BT Trade d.o.o.**  
T (+386) 41 676 006  
info@butiksvetil.si

## Türkiye

**Soho Aydınlatma Ticaret Ltd.**  
T (+90) 2165 7669 41  
kartal.kendirci@soholight.com

## Ukraine

**MAX Light**  
T (+38) 4446 37942  
tanya@maxlight.ua

# OUTDOOR

## **TRIO Leuchten GmbH**

Gut Nierhof 17  
D-59757 Arnsberg  
T +49 2931 9666-0  
F +49 2931 9666-28  
info@trio-leuchten.de  
www.trio-leuchten.de

## **Reality Leuchten GmbH**

Gut Nierhof 17  
D-59757 Arnsberg  
T +49 2931 9666-99  
F +49 2931 9666-98  
info@reality-leuchten.de  
www.reality-leuchten.de

## **TRIO International GmbH**

Gut Nierhof 17  
D-59757 Arnsberg  
T +49 2931 9666-587  
F +49 2931 9666-56  
info@trio-lighting.com  
www.trio-lighting.com

 /trioleuchten

 @trio.lighting

 @trioleuchten

 @TRIO Lighting Group

 @triolighting

