



MADE IN ITALY



TOP SELECTION GARDEN 2024

CLASSIC RANGE



MODERN RANGE



SOLAR RANGE

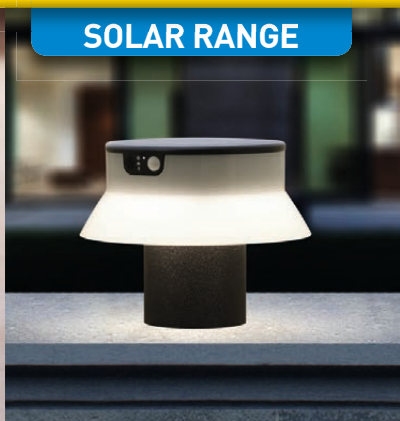

CLASSIC RANGE

REVIVAL



HEXAGONAL



GLOBES



GARDEN SMALL

GARDEN MEDIUM

GARDEN LARGE

HALF LANTERN

BOLLARD



BISSO/ANNA
for details see pag. 37



E22.131

Q18.110

MIKROLOT/MARY
for details see pag. 45



DISMA/ROBY
for details see pag. 17



T20.114

NEW ENTRY!

H21.240

NARDO/GIAMPI
for details see pag. 11



NEW

M21.000

FABIO
for details see pag. 15



IESSE
for details see pag. 89

M23.000



MODERN RANGE

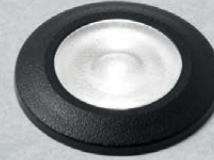
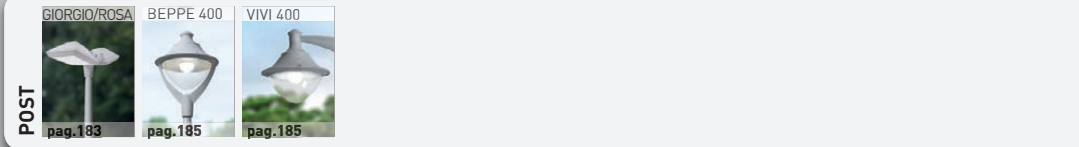
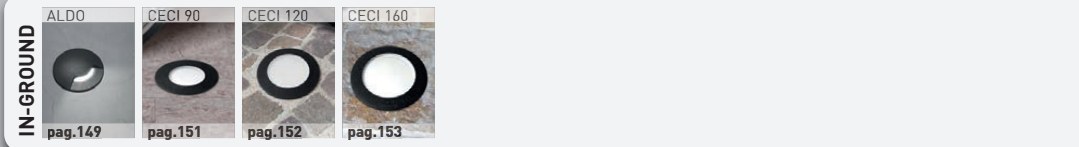
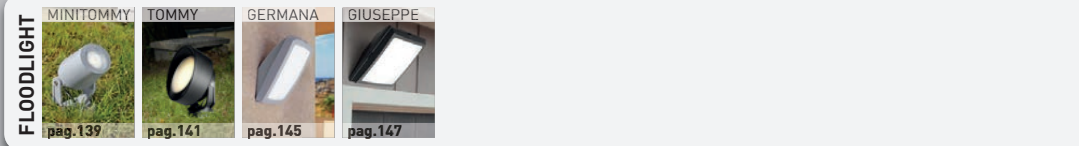

1L0.000

ALDO

for details see pag.149



CARLOO 800

for details see pag.105

DR1.575

2A3.000



MAMETE

for details see pag.127

LIVIA 60

for details see pag.123



1A9.000

TERESA 90

for details see pag.120



3L1.000

AB1.000



ABRAM150

for details see pag.129

MINITOMMY-EL

for details see pag.139



1M2.001

LUCIA

for details see pag.179



1R4.000

DS1.563



ESTER 500

for details see pag.99

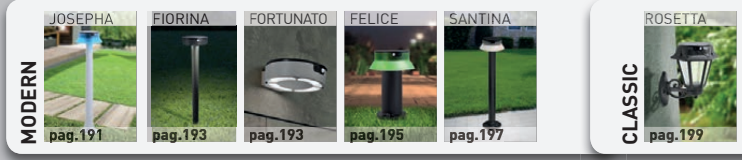

NEW VERSION
SOLAR MODULE

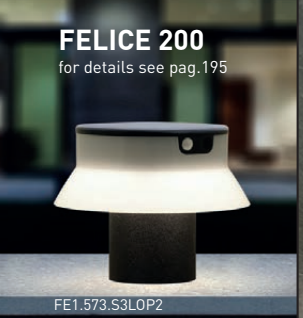

SAVE UP TO
40% VOLUME

MADE IN ITALY

SINGLE BOX



SMART PACK



- ✓ SAVE UP TO 40% VOLUME
- ✓ ECO-FRIENDLY PACKAGING
- ✓ FILM WRAPPED ITEMS

AVAILABLE FOR:

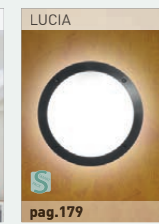
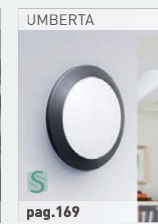
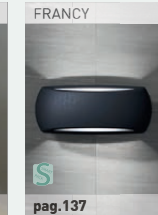
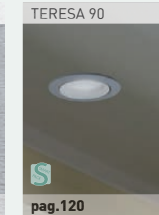



BISSO/ANNA
for details see pag. 37



IESSE
for details see pag. 89



NARDO/GIAMPY
for details see pag. 11



**NEW
ENTRY!**



NEW
HALF LANTERN
FABIO

FABIO
for details see pag.15



PROMO GARDEN 2024 - CLASSIC RANGE



DISMA/ROBY
for details see pag. 17

NEW
POST
EMILIO

EMILIO/SERGIO
for details see pag. 26



MIKROLOT/MARY
for details see pag. 45



SICAR/G250
for details see pag. 29

NEW
SICAR IN
GREY COLOUR



NARDO/G250
for details see pag. 29



GIAMPY RANGE

SMALL SIZE



MADE IN ITALY

NEW

GREY COLOUR AVAILABLE

CCT SET	
6,5W 800 lm 2700 K	8,5W 920 lm 2700 K
11W 1200 lm 4000 K	11W 1200 lm 6500 K

More details at page 201



H21.114.V1K

NEW ENTRY!



SMALL SIZE

GIAMPY RANGE

AVAILABLE COLORS		
RESIN BODY	DIFFUSER	
BLACK (A) NEW COLOUR GREY (L) WHITE (W)	CLEAR (X) OPAL (Y)	

E27 CCT LED VERSION	
	8,5W 920 lm 100-240V 50/60 Hz 2700K/4000K/6500K CCT SET = 75W INCANDESCENT

E27 FILAMENT LED VERSION	
	6,5W 800 lm 100-240V 50/60 Hz 2700K = 60W INCANDESCENT

E27 VERSION	

NARDO/GIAMPY

IP55	6,5W FILAMENT 2700K	H21.240.F1R
	8,5W CCT SET	H21.240.V1K
	E27	H21.240.E27

Master box: 18pcs

DISMA/GIAMPY		
6,5W FILAMENT 2700K	H21.114.F1R	
8,5W CCT SET	H21.114.V1K	
E27	H21.114.E27	

SICAR/GIAMPY		
6,5W FILAMENT 2700K	H21.125.F1R	
8,5W CCT SET	H21.125.V1K	
E27	H21.125.E27	

Master box: 18pcs

Master box: 18pcs

10	REVIVAL
36	GARDEN SMALL
52	GARDEN MEDIUM
72	GARDEN LARGE
88	HALF LANTERN
90	BOLLARD
96	BOLLARD
118	DOWNLIGHT
126	UP&DOWN
138	FLOODLIGHT
148	IN-GROUND
154	BRICKLIGHT
164	BULKHEAD
183	POST
190	SOLAR MODERN
198	SOLAR CLASSIC
200	LAMPS

GIAMPY RANGE

SMALL SIZE



AVAILABLE COLORS

RESIN BODY		DIFFUSER	
BLACK (A)	GREY (L)	CLEAR (X)	OPAL (Y)

E27 CCT LED VERSION

	8,5W
	920 lm
	100-240V
	50/60 Hz
	2700K/4000K/6500K
CCT SET	75W
	INCANDESCENT

E27 FILAMENT LED VERSION

	6,5W
	800 lm
	100-240V
	50/60 Hz
	2700K
CCT SET	60W
	INCANDESCENT



GIAFFA/GIAMPY (resin)

	6,5W 2700K FILAMENT	H21.242.F1R
	8,5W CCT SET	H21.242.V1K

LED LAMP INCLUDED

COMING SOON
available from December 2024

DANILO/GIAMPY

	6,5W 2700K FILAMENT	H21.305.F1R
	8,5W CCT SET	H21.305.V1K

LED LAMP INCLUDED

COMING SOON
available from December 2024



SMALL SIZE

GIAMPY RANGE

"METAL POST COVERED BY RESIN"

fumaTech
FUMAGALLI POLES TECHNOLOGY

ANTI RUST LIFETIME GUARANTEE
NO PAINTING REQUIRED
MADE IN ITALY

ANTI CORROSION **UV-RAYS STABILIZED** **NO MAINTENANCE** **DOUBLE INSULATION** **NOT AFFECTED BY CHEMICAL FERTILIZERS**

DINO NARDO/GIAMPY 2L

	6,5W 2700K FILAMENT	H21.306.D20.F1R
	8,5W CCT SET	H21.306.D20.V1K

LED LAMP INCLUDED

COMING SOON
available from December 2024

DINO NARDO/GIAMPY 3L

	6,5W 2700K FILAMENT	H21.306.D30.F1R
	8,5W CCT SET	H21.306.D30.V1K

LED LAMP INCLUDED

COMING SOON
available from December 2024

10	REIVAL
36	GARDEN SMALL
52	GARDEN MEDIUM
72	GARDEN LARGE
88	HALF LANTERN
90	BOLLARD
96	BOLLARD
118	DOWNLIGHT
126	UP&DOWN
138	FLOODLIGHT
148	IN-GROUND
154	BRICKLIGHT
164	BULKHEAD
183	POST
190	SOLAR MODERN
198	SOLAR CLASSIC
200	LAMPS

REVIVAL

FABIO

HALF LANTERN



MADE IN ITALY



M20.000.E27

SMART PACK AVAILABLE

AVAILABLE COLORS

RESIN BODY
 NEW COLOUR: GREY (L), WHITE (W)
 BLACK (A)

DIFFUSER
 CLEAR (X), OPAL (Y)

E27 CCT LED VERSION

6,5W	8,5W	11W
800 lm	920 lm	1200 lm
2700 K	2700 K	4000 K
		6500 K

More details at page 201



HALF LANTERN

AVAILABLE COLORS

RESIN BODY
 NEW COLOUR: GREY (L), WHITE (W)
 BLACK (A)

DIFFUSER
 CLEAR (X), OPAL (Y)

E27 CCT LED VERSION

8,5W
920 lm
100-240V
50/60 Hz
2700K/4000K/6500K

E27 FILAMENT LED VERSION

6,5W
800 lm
100-240V
50/60 Hz
2700K

E27 VERSION

75W INCANDESCENT
60W INCANDESCENT

FABIO

IP55

E27	M21.000.E27	SMART PACK
E27	M20.000.E27	SINGLE BOX
6,5W FILAMENT	M20.000.F1R	SINGLE BOX
8,5W CCT SET	M20.000.V1K	SINGLE BOX

Standard Master box: **18pcs**
 Smart Pack Master box: **24pcs**

NEW

NEW
GREY COLOUR AVAILABLE

FABIO - AVAILABLE VERSIONS

FABIO E27 SINGLE BOX	FABIO E27 SMART PACK
cbm: 0,16 Master box: 18 pcs	<p>SAVE 35% VOLUME</p> <ul style="list-style-type: none"> Save 35% volume ECO-friendly packaging Film wrapped items
	cbm: 0,14 Master box: 24 pcs

MADE IN ITALY

- 10 REVIVAL
- 36 GARDEN SMALL
- 52 GARDEN MEDIUM
- 72 GARDEN LARGE
- 88 HALF LANTERN
- 90 BOLLARD
- 96 BOLLARD
- 118 DOWNLIGHT
- 126 UP&DOWN
- 138 FLOODLIGHT
- 148 IN-GROUND
- 154 BRICKLIGHT
- 164 BULKHEAD
- 183 POST
- 190 SOLAR MODERN
- 198 SOLAR CLASSIC
- 200 LAMPS

ROBY RANGE

SMALL SIZE



MADE IN ITALY

6,5W	8,5W	11W
800 lm	920 lm	1200 lm
2700 K	2700 K	4000 K 6500 K

More details at page 201



T20.240.E27

NEW
GREY COLOUR
AVAILABLE



SMALL SIZE

ROBY RANGE

AVAILABLE COLORS		E27 CCT LED VERSION	E27 FILAMENT LED VERSION	E27 VERSION
RESIN BODY	DIFFUSER	8,5W 920 lm 100-240V 50/60 Hz 2700K/4000K/6500K	6,5W 800 lm 100-240V 50/60 Hz 2700K	
BLACK (A)	CLEAR (X)	CCT SET = 75W INCANDESCENT	= 60W INCANDESCENT	
NEW COLOUR GREY (L)	WHITE (W)			OPAL (Y)

NARDO/ROBY

IP55	6,5W 2700K FILAMENT	T20.240.F1R
	8,5W CCT SET	T20.240.V1K
	E27	T20.240.E27

Master box: 18pcs

DISMA/ROBY	
6,5W 2700K FILAMENT	T20.114.F1R
8,5W CCT SET	T20.114.V1K
E27	T20.114.E27

SICAR/ROBY	
6,5W 2700K FILAMENT	T20.125.F1R
8,5W CCT SET	T20.125.V1K
E27	T20.125.E27

Master box: 18pcs

Master box: 18pcs

MADE IN ITALY

10	REVIVAL
36	GARDEN SMALL
52	GARDEN MEDIUM
72	GARDEN LARGE
88	HALF LANTERN
90	BOLLARD
96	BOLLARD
118	DOWNLIGHT
126	UP&DOWN
138	FLOODLIGHT
148	IN-GROUND
154	BRICKLIGHT
164	BULKHEAD
183	POST
190	SOLAR MODERN
198	SOLAR CLASSIC
200	LAMPS

ROBY RANGE

SMALL SIZE



AVAILABLE COLORS

RESIN BODY			DIFFUSER	
BLACK (A)	GREY (L)	WHITE (W)	CLEAR (X)	OPAL (Y)

E27 CCT LED VERSION

	8,5W
	920 lm
	100-240V
	50/60 Hz
	2700K/4000K/6500K
	75W
	INCANDESCENT

E27 CCT LED VERSION

	6,5W
	800 lm
	100-240V
	50/60 Hz
	2700K
	60W
	INCANDESCENT

GIAFFA/ROBY (resin)

6,5W	T20.242.F1R
8,5W	T20.242.V1K

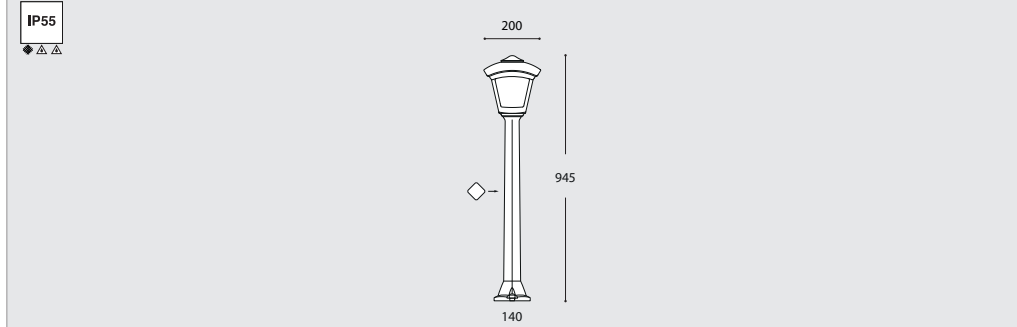

NEW



SMALL SIZE

ROBY RANGE

"METAL POST COVERED BY RESIN"

fumaTech FUMAGALLI POLES TECHNOLOGY

LIFETIME GUARANTEE (ANTI RUST, NO PAINTING REQUIRED)

MADE IN ITALY

ANTI CORROSION **UV-RAYS STABILIZED** **NO MAINTENANCE** **DOUBLE INSULATION** **NOT AFFECTED BY CHEMICAL FERTILIZERS**

DANILO NARDO/ROBY 2L

6,5W	T20.305.D20.F1R
8,5W	T20.305.D20.V1K



NEW

DANILO NARDO/ROBY 3L

6,5W	T20.305.D30.F1R
8,5W	T20.305.D30.V1K



NEW

10	REVIVAL
36	GARDEN SMALL
52	GARDEN MEDIUM
72	GARDEN LARGE
88	HALF LANTERN
90	BOLLARD
96	BOLLARD
118	DOWNLIGHT
126	UP&DOWN
138	FLOODLIGHT
148	IN-GROUND
154	BRICKLIGHT
164	BULKHEAD
183	POST
190	SOLAR MODERN
198	SOLAR CLASSIC
200	LAMPS

DARIO RANGE

MEDIUM SIZE



MADE IN ITALY

AVAILABLE COLORS		CCT SET	
RESIN BODY	DIFFUSER	6500K	2700K
BLACK (A) NEW COLOUR GREY (L) WHITE (W)	CLEAR (X) OPAL (Y)	6,5W 800 lm	8,5W 920 lm
		2700 K	4000 K 6500 K

More details at page 201



T24.116.V1K

NEW
GREY COLOUR
AVAILABLE



MEDIUM SIZE

DARIO RANGE

AVAILABLE COLORS		E27 CCT LED VERSION	E27 FILAMENT LED VERSION	E27 VERSION
BLACK (A) NEW COLOUR GREY (L) WHITE (W)	CLEAR (X) OPAL (Y)	8,5W 920 lm 100-240V 50/60 Hz 2700K/4000K/6500K CCT SET E27 75W INCANDESCENT	6,5W 800 lm 100-240V 50/60 Hz 2700K E27 60W INCANDESCENT	

NARDO/DARIO



NEW

IP55	6,5W 2700K FILAMENT	T24.240.F1R
	8,5W CCT SET	T24.240.V1K
E27		T24.240.E27

Master box: 12pcs

MIDIDISMA/DARIO

	6,5W 2700K FILAMENT	T24.116.F1R
	8,5W CCT SET	T24.116.V1K
E27		T24.116.E27

NEW BASE MIDIDISMA

Master box: 12pcs

NEW

SICAR/DARIO

	6,5W 2700K FILAMENT	T24.125.F1R
	8,5W CCT SET	T24.125.V1K
E27		T24.125.E27

Master box: 12pcs

NEW

10	REVIVAL
36	GARDEN SMALL
52	GARDEN MEDIUM
72	GARDEN LARGE
88	HALF LANTERN
90	BOLLARD
96	BOLLARD
118	DOWNLIGHT
126	UP&DOWN
138	FLOODLIGHT
148	IN-GROUND
154	BRICKLIGHT
164	BULKHEAD
183	POST
190	SOLAR MODERN
198	SOLAR CLASSIC
200	LAMPS

"METAL POST COVERED BY RESIN"

STEEL
RESIN
EXPANSE

fumaTech
FUMAGALLI POLES TECHNOLOGY

ANTI RUST
LIFETIME GUARANTEE
NO PAINTING REQUIRED

MADE IN ITALY

ANTI CORROSION
UV-RAYS STABILIZED
NO MAINTENANCE
DOUBLE INSULATION
NOT AFFECTED BY CHEMICAL FERTILIZES

GIAFFA/DARIO (resin)

IP55

6,5W 2700K FILAMENT	T24.242.F1R
8,5W CCT SET	T24.242.V1K

LED LAMP INCLUDED

240
975
140

NEW

DANILO/DARIO

IP55

6,5W 2700K FILAMENT	T24.305.F1R
8,5W CCT SET	T24.305.V1K

LED LAMP INCLUDED

240
1750
Ø245

NEW

DINO/DARIO

IP55

6,5W 2700K FILAMENT	T24.306.F1R
8,5W CCT SET	T24.306.V1K

LED LAMP INCLUDED

240
1950
Ø245

NEW

DINO NARDO/DARIO 2L

IP55

6,5W 2700K FILAMENT	T24.306.D20.F1R
8,5W CCT SET	T24.306.D20.V1K

LED LAMP INCLUDED

630
1960
Ø245

NEW

DINO NARDO/DARIO 3L

IP55

6,5W 2700K FILAMENT	T24.306.D30.F1R
8,5W CCT SET	T24.306.D30.V1K

LED LAMP INCLUDED

620
1960
Ø245

NEW

EMILIO NARDO/DARIO 2L

IP55

6,5W 2700K FILAMENT	T24.307.D20.F1R
8,5W CCT SET	T24.307.D20.V1K

LED LAMP INCLUDED

630
2200
Ø245

NEW

EMILIO NARDO/DARIO 3L

IP55

6,5W 2700K FILAMENT	T24.307.D30.F1R
8,5W CCT SET	T24.307.D30.V1K

LED LAMP INCLUDED

620
2200
Ø245

NEW

- 10 REVIVAL
- 36 GARDEN SMALL
- 52 GARDEN MEDIUM
- 72 GARDEN LARGE
- 88 HALF LANTERN
- 90 BOLLARD
- 96 BOLLARD
- 118 DOWNLIGHT
- 126 UP&DOWN
- 138 GARDEN MODERN FLOODLIGHT
- 148 IN-GROUND
- 154 BRICKLIGHT
- 164 BULKHEAD
- 183 POST
- 190 SOLAR MODERN
- 198 SOLAR CLASSIC
- 200 LAMPS

SERGIO RANGE

LARGE SIZE



MADE IN ITALY



HIGH POWER LED VERSION

T33.117.Q1K

E27 HIGH POWER LED

INDOOR & OUTDOOR USE

+80°C
-30°C

90% HUMIDITY

VOLTAGE SURGE RESISTANT

15W (1690 lm)
30W (3620 lm)
50W (6550 lm)

More details at page 202



NEW
GREY COLOUR AVAILABLE



LARGE SIZE

SERGIO RANGE

AVAILABLE COLORS

RESIN BODY	DIFFUSER
BLACK (A) GREY (L) WHITE (W)	CLEAR (X) OPAL (Y)

E27 HIGH POWER LED VERSION

15W	30W
1690 lm	3620 lm
100-240V 50/60 Hz	100-240V 50/60 Hz
4000K/3000K	4000K/3000K
= SERGIO 100W INCANDESCENT	= SERGIO 70W HQI-SOON

IOLE/SERGIO

15W LED	CCT SET	T33.243.R1K
30W LED	CCT SET	T33.243.Q1K

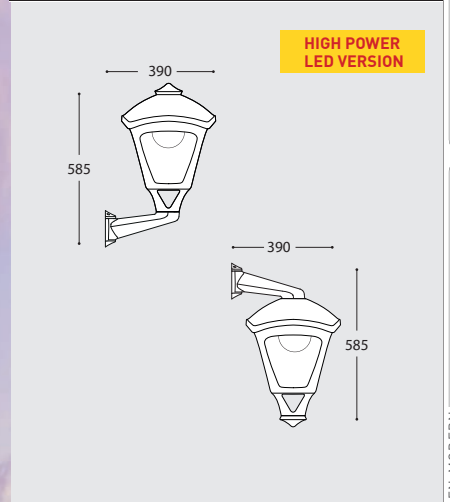

MAXIDISMA/SERGIO

15W LED	CCT SET	T33.117.R1K
30W LED	CCT SET	T33.117.Q1K

SICAR/SERGIO

15W LED	CCT SET	T33.126.R1K
30W LED	CCT SET	T33.126.Q1K



- 10 REVIVAL
- 36 GARDEN SMALL
- 52 GARDEN MEDIUM
- 72 GARDEN LARGE
- 88 HALF LANTERN
- 90 BOLLARD
- 96 BOLLARD
- 118 DOWNLIGHT
- 126 UP&DOWN
- 138 FLOODLIGHT
- 148 IN-GROUND
- 154 BRICKLIGHT
- 164 BULKHEAD
- 183 POST
- 190 SOLAR MODERN
- 198 SOLAR CLASSIC
- 200 LAMPS

SERGIO RANGE

LARGE SIZE

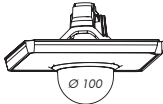

E27 HIGH POWER LED VERSION					
LAMP	POWER	LUMINOUS FLUX UP TO	VOLTAGE RANGE	CCT SETTABLE	COMPARISON
	15W	1690 lm	100-240V 50/60 Hz	4000K/3000K	= SERGIO = 100W INCANDESCENT
	30W	3620 lm	100-240V 50/60 Hz	4000K/3000K	= SERGIO = 70W HID-SOD

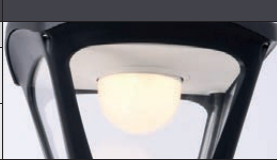

LARGE SIZE

SERGIO RANGE

"METAL POST COVERED BY RESIN"

STEEL
RESIN
EXPANSE

ANTI RUST
LIFETIME GUARANTEE
NO PAINTING REQUIRED

MADE IN ITALY

ANTI CORROSION | UV-RAYS STABILIZED | NO MAINTENANCE | DOUBLE INSULATION | NOT AFFECTED BY CHEMICAL FERTILIZERS

fumaTech
FUMAGALLI POLES TECHNOLOGY

DANILO/SERGIO

15W LED	CCT SET	T33.305.R1K
30W LED	CCT SET	T33.305.Q1K

IP55	HIGH POWER LED VERSION
------	------------------------



DINO/SERGIO

15W LED	CCT SET	T33.306.R1K
30W LED	CCT SET	T33.306.Q1K

IP55	HIGH POWER LED VERSION
------	------------------------

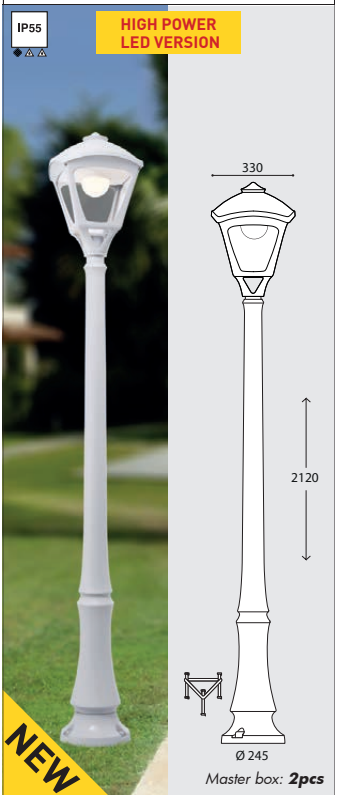

EMILIO/SERGIO

15W LED	CCT SET	T33.307.R1K
30W LED	CCT SET	T33.307.Q1K

IP55	HIGH POWER LED VERSION
------	------------------------

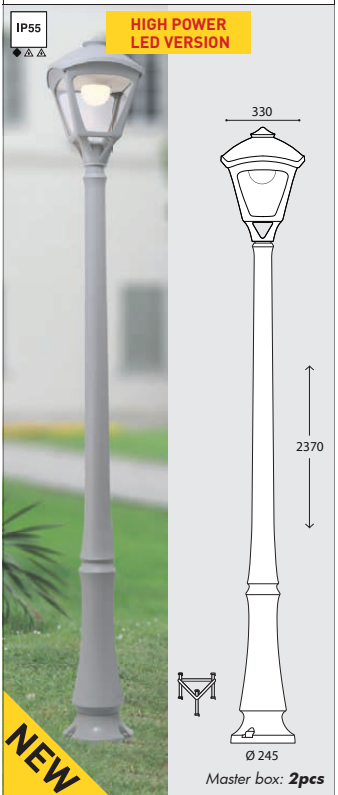

VANNI 2500/SERGIO

30W LED	CCT SET	T33.310.Q1K
---------	---------	-------------

IP55	HIGH POWER LED VERSION
------	------------------------



VANNI 2500 IOLE/SERGIO 2L

30W LED	CCT SET	T33.310.E20.Q1K
---------	---------	-----------------

IP55	HIGH POWER LED VERSION
------	------------------------



- 10 REIVAL
- 36 GARDEN SMALL
- 52 GARDEN MEDIUM
- 72 GARDEN LARGE
- 88 HALF LANTERN
- 90 BOLLARD
- 96 BOLLARD
- 118 DOWNLIGHT
- 126 UP&DOWN
- 138 FLOODLIGHT
- 148 IN-GROUND
- 154 BRICKLIGHT
- 164 BULKHEAD
- 183 POST
- 190 SOLAR MODERN
- 198 SOLAR CLASSIC
- 200 LAMPS

GLOBE 250 RANGE

MODERN



MADE IN ITALY

6,5W 800 lm 2700 K	8,5W 920 lm 2700 K	11W 1200 lm 4000 K	11W 1200 lm 6500 K
--------------------------	--------------------------	--------------------------	--------------------------

More details at page 201



G26.240.E27

NEW
GREY COLOUR
AVAILABLE



GLOBE 250 MODERN

AVAILABLE COLORS			E27 CCT LED VERSION	E27 FILAMENT LED VERSION	E27 VERSION
RESIN BODY BLACK (A) NEW COLOUR GREY (L) WHITE (W)			8,5W 920 lm 100-240V 50/60 Hz 2700K/4000K/6500K CCT SET = 75W INCANDESCENT	6,5W 800 lm 100-240V 50/60 Hz 2700K = 60W INCANDESCENT	E27 VERSION
DIFFUSER CLEAR (X) OPAL (V) SMOKED (Z)					

NARDO/G250

IP55	6,5W 2700K FILAMENT	G26.240.F1R
	8,5W CCT SET	G26.240.V1K
E27		G26.240.E27

Master box: 36pcs

DISMA/G250

IP55	6,5W 2700K FILAMENT	G26.114.F1R
	8,5W CCT SET	G26.114.V1K
E27		G26.114.E27

NEW BASE MIDIDISMA

Master box: 36pcs

SICAR/G250

IP55	6,5W 2700K FILAMENT	G26.125.F1R
	8,5W CCT SET	G26.125.V1K
E27		G26.125.E27

Master box: 36pcs

- 10 REVIVAL
- 36 GARDEN SMALL
- 52 GARDEN MEDIUM
- 72 GARDEN LARGE
- 88 HALF LANTERN
- 90 BOLLARD
- 96 BOLLARD
- 118 DOWNLIGHT
- 126 UP&DOWN
- 138 FLOODLIGHT
- 148 IN-GROUND
- 154 BRICKLIGHT
- 164 BULKHEAD
- 183 POST
- 190 SOLAR MODERN
- 198 SOLAR CLASSIC
- 200 LAMPS

GLOBE 250 MODERN

SMALL SIZE



AVAILABLE COLORS

RESIN BODY

NEW COLOUR

BLACK (A) GREY (L) WHITE (W)

DIFFUSER

CLEAR (X) OPAL (Y) SMOCKED (Z)

E27 CCT LED VERSION

8,5W
920 lm
100-240V
50/60 Hz
2700K/4000K/6500K

CCT SET
75W INCANDESCENT

E27 FILAMENT LED VERSION

6,5W
800 lm
100-240V
50/60 Hz
2700K

60W INCANDESCENT



GIAFFA/G250 (resin)

6,5W 2700K FILAMENT	G26.242.F1R
8,5W CCT SET	G26.242.V1K

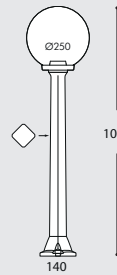

Master box: 2pcs

DANILO/G250

IP55

6,5W 2700K FILAMENT	G26.305.F1R
8,5W CCT SET	G26.305.V1K

LED LAMP INCLUDED

Master box: 2pcs

DINO/G250

IP55

6,5W 2700K FILAMENT	G26.306.F1R
8,5W CCT SET	G26.306.V1K

LED LAMP INCLUDED

Master box: 2pcs



SMALL SIZE

GLOBE 250 MODERN

"METAL POST COVERED BY RESIN"

STEEL
RESIN
EXPANSE

ANTI RUST
LIFETIME GUARANTEE
NO PAINTING REQUIRED

MADE IN ITALY

ANTI CORROSION
UV-RAYS STABILIZED
NO MAINTENANCE
DOUBLE INSULATION
NOT AFFECTED BY CHEMICAL FERTILIZERS

DINO NARDO/G250 2L

IP55

6,5W 2700K FILAMENT	G26.306.D20.F1R
8,5W CCT SET	G26.306.D20.V1K

LED LAMP INCLUDED

Master box: 2pcs

DINO NARDO/G250 3L

IP55

6,5W 2700K FILAMENT	G26.306.D30.F1R
8,5W CCT SET	G26.306.D30.V1K

LED LAMP INCLUDED

Master box: 2pcs

10	REIVAL
36	GARDEN SMALL
52	GARDEN MEDIUM
72	GARDEN LARGE
88	HALF LANTERN
90	BOLLARD
96	BOLLARD
118	DOWNLIGHT
126	UP&DOWN
138	FLOODLIGHT
148	IN-GROUND
154	BRICKLIGHT
164	BULKHEAD
183	POST
190	SOLAR MODERN
198	SOLAR CLASSIC
200	LAMPS

GLOBE 300 RANGE

MODERN



MADE IN ITALY

CCT SET		
6,5W 800 lm 2700 K	8,5W 920 lm 2700 K	11W 1200 lm 4000 K / 6500 K

More details at page 201



NEW
GREY COLOUR AVAILABLE

G31.116.E27



AVAILABLE COLORS			E27 CCT LED VERSION	E27 FILAMENT LED VERSION	E27 VERSION
RESIN BODY BLACK (A) GREY (L) WHITE (W)			11W 1200 lm 100-240V 50/60 Hz 2700K/4000K/6500K CCT SET = 75W INCANDESCENT	6,5W 800 lm 100-240V 50/60 Hz 2700K CCT SET = 60W INCANDESCENT	
DIFFUSER CLEAR (X) OPAL (Y) SMOKED (Z)					

NARDO/G300

IP55	6,5W FILAMENT 2700K	G31.240.F1R
	11W CCT SET	G31.240.T1K
	E27	G31.240.E27

Master box: 24pcs

MIDIDISMA/G300		SICAR/G300	
6,5W FILAMENT 2700K	G31.116.F1R	6,5W FILAMENT 2700K	G31.125.F1R
11W CCT SET	G31.116.T1K	11W CCT SET	G31.125.T1K
E27	G31.116.E27	E27	G31.125.E27

NEW BASE MIDIDISMA

Master box: 24pcs

Master box: 24pcs

10	REVIVAL
36	GARDEN SMALL
52	GARDEN MEDIUM
72	GARDEN LARGE
88	HALF LANTERN
90	BOLLARD
96	BOLLARD
118	DOWNLIGHT
126	UP&DOWN
138	FLOODLIGHT
148	IN-GROUND
154	BRICKLIGHT
164	BULKHEAD
183	POST
190	SOLAR MODERN
198	SOLAR CLASSIC
200	LAMPS

GLOBE 300 MODERN

MEDIUM SIZE



AVAILABLE COLORS

RESIN BODY			DIFFUSER		
BLACK (A)	GREY (L)	WHITE (W)	CLEAR (X)	OPAL (Y)	SMOKED (Z)

E27 CCT LED VERSION

	8,5W
	920 lm
	100-240V
	50/60 Hz
	2700K/4000K/6500K
	75W
	INCANDESCENT

E27 FILAMENT LED VERSION

	6,5W
	800 lm
	100-240V
	50/60 Hz
	2700K
	60W
	INCANDESCENT

GIAFFA/G300 (resin)

	6,5W 2700K FILAMENT	G31.242.F1R
	8,5W CCT SET	G31.242.T1K

Master box: **2pcs**

DANILO/G300

6,5W 2700K FILAMENT	G31.305.F1R
11W CCT SET	G31.305.T1K

IP55

LED LAMP INCLUDED

Master box: **2pcs**

DINO/G300

6,5W 2700K FILAMENT	G31.306.F1R
11W CCT SET	G31.306.T1K

IP55

LED LAMP INCLUDED

Master box: **2pcs**

EMILIO/G300

6,5W 2700K FILAMENT	G31.307.F1R
11W CCT SET	G31.307.T1K

IP55

LED LAMP INCLUDED

Master box: **2pcs**



MEDIUM SIZE

GLOBE 300 MODERN

"METAL POST COVERED BY RESIN"

STEEL
RESIN
EXPANSE

fumaTech
FUMAGALLI POLES TECHNOLOGY

ANTI RUST
LIFETIME GUARANTEE
NO PAINTING REQUIRED

MADE IN ITALY

ANTI CORROSION
UV-RAYS STABILIZED
NO MAINTENANCE
DOUBLE INSULATION
NOT AFFECTED BY CHEMICAL FERTILIZERS

EMILIO NARDO/G300 2L

6,5W 2700K FILAMENT	G31.307.D20.F1R
11W CCT SET	G31.307.D20.T1K

IP55

LED LAMP INCLUDED

Master box: **2pcs**

EMILIO NARDO/G300 3L

6,5W 2700K FILAMENT	G31.307.D30.F1R
11W CCT SET	G31.307.D30.T1K

IP55

LED LAMP INCLUDED

Master box: **2pcs**

- 10 REVAL
- 36 GARDEN SMALL
- 52 GARDEN MEDIUM
- 72 GARDEN LARGE
- 88 HALF LANTERN
- 90 BOLLARD
- 96 BOLLARD
- 118 DOWNLIGHT
- 126 UP&DOWN
- 138 FLOODLIGHT
- 148 IN-GROUND
- 154 BRICKLIGHT
- 164 BULKHEAD
- 183 POST
- 190 SOLAR MODERN
- 198 SOLAR CLASSIC
- 200 LAMPS

ANNA RANGE

SMALL SIZE

MADE IN ITALY



CCT SET		
6,5W 800 lm 2700 K	8,5W 920 lm 2700 K	11W 1200 lm 6500 K

More details at page 201

E22.110.V1K



AVAILABLE COLORS				E27 CCT LED VERSION	E27 FILAMENT LED VERSION	E27 VERSION
RESIN BODY		DIFFUSER				
BLACK (A)	WHITE (W)	CLEAR (X)	OPAL (Y)	8,5W 920 lm 100-240V 50/60 Hz 2700K/4000K/6500K	6,5W 800 lm 100-240V 50/60 Hz 2700K	
				60W INCANDESCENT	60W INCANDESCENT	

BISSO/ANNA

IP55	6,5W 2700K FILAMENT	E22.131.F1R
	8,5W CCT SET	E22.131.V1K
	E27	E22.131.E27

Master box: 18pcs

MIKROLOT/ANNA		SICHEM/ANNA	
6,5W 2700K FILAMENT	E22.110.F1R	6,5W 2700K FILAMENT	E22.120.F1R
8,5W CCT SET	E22.110.V1K	8,5W CCT SET	E22.120.V1K
E27	E22.110.E27	E27	E22.120.E27

Master box: 18pcs

Master box: 18pcs

- 10 REVIVAL
- 36 GARDEN SMALL
- 52 GARDEN MEDIUM
- 72 GARDEN LARGE
- 88 HALF LANTERN
- 90 BOLLARD
- 96 BOLLARD
- 118 DOWNLIGHT
- 126 UP&DOWN
- 138 FLOODLIGHT
- 148 IN-GROUND
- 154 BRICKLIGHT
- 164 BULKHEAD
- 183 POST
- 190 SOLAR MODERN
- 198 SOLAR CLASSIC
- 200 LAMPS

ANNA RANGE

SMALL SIZE



AVAILABLE COLORS

RESIN BODY		DIFFUSER	
BLACK (A)	WHITE (W)	CLEAR (X)	OPAL (Y)

E27 CCT LED VERSION

	8,5W
	920 lm
	100-240V
	50/60 Hz
	2700K/4000K/6500K
	60W INCANDESCENT

E27 FILAMENT LED VERSION

	6,5W
	800 lm
	100-240V
	50/60 Hz
	2700K
	60W INCANDESCENT

MIZAR/ANNA (resin)



6,5W FILAMENT	2700K	E22.151.F1R
8,5W CCT SET		E22.151.V1K

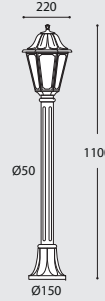

ALOE'R/ANNA (resin)

6,5W FILAMENT	2700K	E22.163.F1R
8,5W CCT SET		E22.163.V1K

ARTU'/ANNA

6,5W FILAMENT	2700K	E22.158.F1R
8,5W CCT SET		E22.158.V1K



SMALL SIZE

ANNA RANGE

"METAL POST COVERED BY RESIN"

fumaTech FUMAGALLI POLES TECHNOLOGY

ANTI RUST LIFETIME GUARANTEE NO PAINTING REQUIRED

MADE IN ITALY

ANTI CORROSION **UV-RAYS STABILIZED** **NO MAINTENANCE** **DOUBLE INSULATION** **NOT AFFECTED BY CHEMICAL FERTILIZERS**

GIGI BISSO/ANNA 2L

6,5W FILAMENT	2700K	E22.156.S20.F1R
8,5W CCT SET		E22.156.S20.V1K

GIGI BISSO/ANNA 3L

6,5W FILAMENT	2700K	E22.156.S30.F1R
8,5W CCT SET		E22.156.S30.V1K

- 10 RENAISSANCE
- 36 GARDEN SMALL
- 52 GARDEN MEDIUM
- 72 GARDEN LARGE
- 88 HALF LANTERN
- 90 BOLLARD
- 96 BOLLARD
- 118 DOWNLIGHT
- 126 GARDEN MODERN UP&DOWN
- 138 FLOODLIGHT
- 148 GARDEN MODERN IN-GROUND
- 154 BRICKLIGHT
- 164 BULKHEAD
- 183 POST
- 190 SOLAR SOLAR MODERN
- 198 SOLAR SOLAR CLASSIC
- 200 LAMPS

SABA RANGE

SMALL SIZE

MADE IN ITALY



CCT SET	
6500K	2700K
6,5W 800 lm 2700 K	8,5W 920 lm 2700 K
	11W 1200 lm 6500 K

More details at page 201



K22.131.F1R



SMALL SIZE

SABA RANGE

AVAILABLE COLORS		E27 CCT LED VERSION	E27 FILAMENT LED VERSION	E27 VERSION
RESIN BODY	DIFFUSER			
BLACK (A)	WHITE (W)	8,5W 920 lm 100-240V 50/60 Hz 2700K/4000K/6500K	6,5W 800 lm 100-240V 50/60 Hz 2700K	
	CLEAR (X)			
	OPAL (Y)			

BISSO/SABA

IP55	6,5W 2700K FILAMENT	K22.131.F1R
	8,5W CCT SET	K22.131.V1K
E27		K22.131.E27

Master box: 18pcs

MIKROLOT/SABA

6,5W 2700K FILAMENT	K22.110.F1R
8,5W CCT SET	K22.110.V1K
E27	K22.110.E27

Master box: 18pcs

SICHEM/SABA

6,5W 2700K FILAMENT	K22.120.F1R
8,5W CCT SET	K22.120.V1K
E27	K22.120.E27

Master box: 18pcs

- 10 REVIVAL
- 36 GARDEN SMALL
- 52 GARDEN MEDIUM
- 72 GARDEN LARGE
- 88 HALF LANTERN
- 90 BOLLARD
- 96 BOLLARD
- 118 DOWNLIGHT
- 126 UP&DOWN
- 138 FLOODLIGHT
- 148 IN-GROUND
- 154 BRICKLIGHT
- 164 BULKHEAD
- 183 POST
- 190 SOLAR MODERN
- 198 SOLAR CLASSIC
- 200 LAMPS

SABA RANGE

SMALL SIZE



AVAILABLE COLORS

RESIN BODY		DIFFUSER	
BLACK (A)	WHITE (W)	CLEAR (X)	OPAL (Y)

E27 CCT LED VERSION

	8,5W
	920 lm
	100-240V
	50/60 Hz
	2700K/4000K/6500K
	60W INCANDESCENT

E27 FILAMENT LED VERSION

	6,5W
	800 lm
	100-240V
	50/60 Hz
	2700K
	60W INCANDESCENT

MIZAR/SABA (resin)

	6,5W 2700K FILAMENT	K22.151.F1R
	8,5W	K22.151.V1K

LED LAMP INCLUDED

ALOE'R/SABA (resin)

	6,5W 2700K FILAMENT	K22.163.F1R
	8,5W	K22.163.V1K

LED LAMP INCLUDED

ARTU'/SABA

	6,5W 2700K FILAMENT	K22.158.F1R
	8,5W	K22.158.V1K

LED LAMP INCLUDED



SMALL SIZE

SABA RANGE

"METAL POST COVERED BY RESIN"

STEEL
RESIN
EXPANSE

fumaTech
FUMAGALLI POLES TECHNOLOGY

ANTI RUST
LIFETIME GUARANTEE
NO PAINTING REQUIRED

MADE IN ITALY

ANTI CORROSION
UV-RAYS STABILIZED
NO MAINTENANCE
DOUBLE INSULATION
NOT AFFECTED BY CHEMICAL FERTILIZES

GIGI BISSO/SABA 2L

	6,5W 2700K FILAMENT	K22.156.S20.F1R
	8,5W	K22.156.S20.V1K

LED LAMP INCLUDED

GIGI BISSO/SABA 3L

	6,5W 2700K FILAMENT	K22.156.S30.F1R
	8,5W	K22.156.S30.V1K

LED LAMP INCLUDED

- 10 REVAL
- 36 GARDEN SMALL
- 52 GARDEN MEDIUM
- 72 GARDEN LARGE
- 88 HALF LANTERN
- 90 BOLLARD
- 96 BOLLARD
- 118 DOWNLIGHT
- 126 UP&DOWN
- 138 FLOODLIGHT
- 148 IN-GROUND
- 154 BRICKLIGHT
- 164 BULKHEAD
- 183 POST
- 190 SOLAR MODERN
- 198 SOLAR CLASSIC
- 200 LAMPS

MARY RANGE

SMALL SIZE



MADE IN ITALY

CCT SET		CCT SET	
6,5W	8,5W	11W	
800 lm	920 lm	1200 lm	
2700 K	2700 K	4000 K	6500 K

More details at page 201



Q18.110.F1R



AVAILABLE COLORS		E27 CCT LED VERSION	E27 FILAMENT LED VERSION	E27 VERSION
RESIN BODY	DIFFUSER	8,5W 920 lm 100-240V 50/60 Hz 2700K/4000K/6500K	6,5W 800 lm 100-240V 50/60 Hz 2700K	
BLACK (A)	WHITE (W)	60W INCANDESCENT	60W INCANDESCENT	
CLEAR (X)	OPAL (Y)			

BISSO/MARY

IP55	6,5W 2700K FILAMENT	Q18.131.F1R
	8,5W CCT SET	Q18.131.V1K
E27		Q18.131.E27

Master box: 18pcs

MIKROLOT/MARY		SICHEM/MARY	
6,5W 2700K FILAMENT	Q18.110.F1R	6,5W 2700K FILAMENT	Q18.120.F1R
8,5W CCT SET	Q18.110.V1K	8,5W CCT SET	Q18.120.V1K
E27	Q18.110.E27	E27	Q18.120.E27

MIKROLOT/MARY

Master box: 18pcs

SICHEM/MARY

Master box: 18pcs

- 10 REVAL
- 36 GARDEN SMALL
- 52 GARDEN MEDIUM
- 72 GARDEN LARGE
- 88 HALF LANTERN
- 90 BOLLARD
- 96 BOLLARD
- 118 DOWNLIGHT
- 126 UP&DOWN
- 138 FLOODLIGHT
- 148 IN-GROUND
- 154 BRICKLIGHT
- 164 BULKHEAD
- 183 POST
- 190 SOLAR MODERN
- 198 SOLAR CLASSIC
- 200 LAMPS

MARY RANGE

SMALL SIZE



AVAILABLE COLORS			
RESIN BODY		DIFFUSER	
BLACK (A)	WHITE (W)	CLEAR (X)	OPAL (Y)

E27 CCT LED VERSION	
	8,5W 920 lm 100-240V 50/60 Hz 2700K/4000K/6500K CCT SET 60W INCANDESCENT

E27 FILAMENT LED VERSION	
	6,5W 800 lm 100-240V 50/60 Hz 2700K 60W INCANDESCENT

MIZAR/MARY (resin)



LED LAMP INCLUDED

6,5W FILAMENT	2700K	Q18.151.F1R
8,5W CCT SET		Q18.151.V1K



Dimensions: 180 (arm span), 1080 (height), Ø50 (pole diameter), Ø150 (base diameter)

ARTU'BISSO/MARY 2L



LED LAMP INCLUDED

6,5W FILAMENT	2700K	Q18.158.S20.F1R
8,5W CCT SET		Q18.158.S20.V1K



Dimensions: 570 (arm span), 1830 (height), Ø245 (base diameter)

ARTU'BISSO/MARY 3L



LED LAMP INCLUDED

6,5W FILAMENT	2700K	Q18.158.S30.F1R
8,5W CCT SET		Q18.158.S30.V1K



Dimensions: 520 (arm span), 1830 (height), Ø245 (base diameter)



SMALL SIZE

MARY RANGE

"METAL POST COVERED BY RESIN"



Labels: STEEL, RESIN, EXPANSE

fumaTech FUMAGALLI POLES TECHNOLOGY

ANTI RUST LIFETIME GUARANTEE NO PAINTING REQUIRED

MADE IN ITALY

ANTI CORROSION | UV-RAYS STABILIZED | NO MAINTENANCE | DOUBLE INSULATION | NOT AFFECTED BY CHEMICAL FERTILIZERS

GIGI BISSO/MARY 2L



LED LAMP INCLUDED

6,5W FILAMENT	2700K	Q18.156.S20.F1R
8,5W CCT SET		Q18.156.S20.V1K



Dimensions: 570 (arm span), 2070 (height), Ø245 (base diameter)

GIGI BISSO/MARY 3L



LED LAMP INCLUDED

6,5W FILAMENT	2700K	Q18.156.S30.F1R
8,5W CCT SET		Q18.156.S30.V1K



Dimensions: 520 (arm span), 2070 (height), Ø245 (base diameter)

- 10 REVIVAL
- 36 GARDEN SMALL
- 52 GARDEN MEDIUM
- 72 GARDEN LARGE
- 88 HALF LANTERN
- 90 BOLLARD
- 96 BOLLARD
- 118 DOWNLIGHT
- 126 UP&DOWN
- 138 FLOODLIGHT
- 148 IN-GROUND
- 154 BRICKLIGHT
- 164 BULKHEAD
- 183 POST
- 190 SOLAR MODERN
- 198 SOLAR CLASSIC
- 200 LAMPS

GLOBE 250 CLASSIC

SMALL SIZE



MADE IN ITALY



6,5W 800 lm 2700 K	8,5W 920 lm 2700 K	11W 1200 lm 4000 K	11W 1200 lm 6500 K
--------------------------	--------------------------	--------------------------	--------------------------

More details at page 201



G25.131.F1R



AVAILABLE COLORS		E27 CCT LED VERSION	E27 FILAMENT LED VERSION	E27 VERSION
RESIN BODY BLACK (A) WHITE (W)		DIFFUSER CLEAR (X) OPAL (Y) SMOKED (Z)		
		8,5W 920 lm 100-240V 50/60 Hz 2700K/4000K/6500K CCT SET 60W INCANDESCENT	6,5W 800 lm 100-240V 50/60 Hz 2700K 60W INCANDESCENT	

BISSO/G250



IP55	6,5W 2700K FILAMENT	G25.131.F1R
	8,5W CCT SET	G25.131.V1K
	E27	G25.131.E27

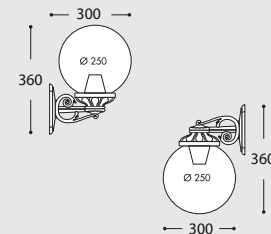

Master box: 36pcs

MIKROLOT/G250

IP55	6,5W 2700K FILAMENT	G25.110.F1R
	8,5W CCT SET	G25.110.V1K
	E27	G25.110.E27

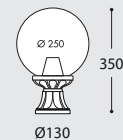

Master box: 36pcs

SICHEM/G250

IP55	6,5W 2700K FILAMENT	G25.120.F1R
	8,5W CCT SET	G25.120.V1K
	E27	G25.120.E27

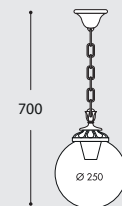

Master box: 36pcs

10	REVIVAL
36	GARDEN SMALL
52	GARDEN MEDIUM
72	GARDEN LARGE
88	HALF LANTERN
90	BOLLARD
96	BOLLARD
118	DOWNLIGHT
126	UP&DOWN
138	FLOODLIGHT
148	IN-GROUND
154	BRICKLIGHT
164	BULKHEAD
183	POST
190	SOLAR MODERN
198	SOLAR CLASSIC
200	LAMPS

GLOBE 250 CLASSIC SMALL SIZE



AVAILABLE COLORS				
RESIN BODY		DIFFUSER		
BLACK (A)	WHITE (W)	CLEAR (X)	OPAL (Y)	SMOKED (Z)

E27 CCT LED VERSION	
	8,5W
	920 lm
	100-240V
	50/60 Hz
	2700K/4000K/6500K
CCT SET	60W INCANDESCENT

E27 FILAMENT LED VERSION	
	6,5W
	800 lm
	100-240V
	50/60 Hz
	2700K
CCT SET	60W INCANDESCENT



MIZAR/G250 (resin)	
6,5W 2700K FILAMENT	G25.151.F1R
8,5W CCT SET	G25.151.V1K

Master box: **2pcs**



ALOE'.R/G250 (resin)	
6,5W 2700K FILAMENT	G25.163.F1R
8,5W CCT SET	G25.163.V1K

Master box: **2pcs**



SMALL SIZE GLOBE 250 CLASSIC

"METAL POST COVERED BY RESIN"

fumaTech FUMAGALLI POLES TECHNOLOGY

ANTI RUST LIFETIME GUARANTEE NO PAINTING REQUIRED

MADE IN ITALY

ANTI CORROSION **UV-RAYS STABILIZED** **NO MAINTENANCE** **DOUBLE INSULATION** **NOT AFFECTED BY CHEMICAL FERTILIZERS**

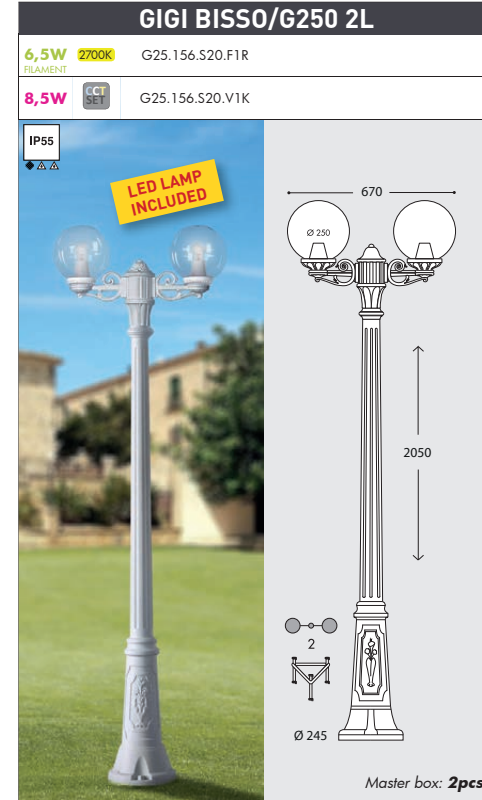

GIGI BISSO/G250 2L	
6,5W 2700K FILAMENT	G25.156.S20.F1R
8,5W CCT SET	G25.156.S20.V1K

Master box: **2pcs**

10	REIVAL
36	GARDEN SMALL
52	GARDEN MEDIUM
72	GARDEN LARGE
88	HALF LANTERN
90	BOLLARD
96	BOLLARD
118	DOWNLIGHT
126	UP&DOWN
138	FLOODLIGHT
148	IN-GROUND
154	BRICKLIGHT
164	BULKHEAD
183	POST
190	SOLAR MODERN
198	SOLAR CLASSIC
200	LAMPS

RUT RANGE

MEDIUM SIZE



MADE IN ITALY



E26.157.S30.F1R

CCT SET	
6500K	4000K
2700K	2700K

6,5W 800 lm 2700 K	8,5W 920 lm 2700 K	11W 1200 lm 4000 K / 6500 K
--------------------------	--------------------------	-----------------------------------

More details at page 201



AVAILABLE COLORS		E27 CCT LED VERSION	E27 FILAMENT LED VERSION	E27 VERSION
RESIN BODY	DIFFUSER			
BLACK (A)	WHITE (W)	11W 1200 lm 100-240V 50/60 Hz 2700K/4000K/6500K	6,5W 800 lm 100-240V 50/60 Hz 2700K	
CLEAR (X)	OPAL (Y)	75W INCANDESCENT	60W INCANDESCENT	

BISSO/RUT

IP55	6,5W FILAMENT 2700K	E26.131.F1R
	11W CCT SET	E26.131.T1K
	E27	E26.131.E27

Master box: 12pcs

MINILOT/RUT		SICHEM/RUT	
6,5W FILAMENT 2700K	E26.111.F1R	6,5W FILAMENT 2700K	E26.120.F1R
11W CCT SET	E26.111.T1K	11W CCT SET	E26.120.T1K
E27	E26.111.E27	E27	E26.120.E27

Master box: 12pcs

Master box: 12pcs

10	REVIVAL
36	GARDEN SMALL
52	GARDEN MEDIUM
72	GARDEN LARGE
88	HALF LANTERN
90	BOLLARD
96	BOLLARD
118	DOWNLIGHT
126	UP&DOWN
138	FLOODLIGHT
148	IN-GROUND
154	BRICKLIGHT
164	BULKHEAD
183	POST
190	SOLAR MODERN
198	SOLAR CLASSIC
200	LAMPS

RUT RANGE

MEDIUM SIZE



AVAILABLE COLORS	
RESIN BODY	DIFFUSER
BLACK (A)	CLEAR (X)
WHITE (W)	OPAL (Y)

E27 CCT LED VERSION	
8,5W	11W
920 lm	1200 lm
100-240V 50/60 Hz	100-240V 50/60 Hz
2700K/4000K/6500K	2700K/4000K/6500K
60W INCANDESCENT	75W INCANDESCENT

E27 FILAMENT LED VERSION	
6,5W	6,5W
800 lm	800 lm
100-240V 50/60 Hz	100-240V 50/60 Hz
2700K	2700K
60W INCANDESCENT	60W INCANDESCENT

MIZAR/RUT (resin)



LED LAMP INCLUDED

6,5W FILAMENT 2700K	E26.151.F1R
8,5W CCT SET	E26.151.V1K
11W CCT SET	E26.151.T1K

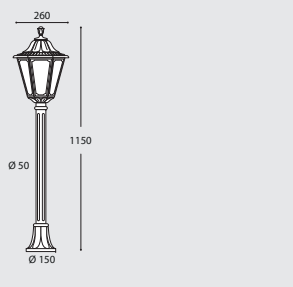

Technical drawing showing a lamp with a height of 1150mm and a diameter of 50mm at the base.

RICU BISSO/RUT 2L



LED LAMP INCLUDED

6,5W FILAMENT 2700K	E26.157.S20.F1R
8,5W CCT SET	E26.157.S20.V1K
11W CCT SET	E26.157.S20.T1K



Technical drawing showing a lamp with a height of 2500mm and a diameter of 245mm at the base.

RICU BISSO/RUT 3L



LED LAMP INCLUDED

6,5W FILAMENT 2700K	E26.157.S30.F1R
8,5W CCT SET	E26.157.S30.V1K
11W CCT SET	E26.157.S30.T1K



Technical drawing showing a lamp with a height of 2500mm and a diameter of 245mm at the base.



MEDIUM SIZE

RUT RANGE

"METAL POST COVERED BY RESIN"



Labels: STEEL, RESIN, EXPANSE.

fumaTech FUMAGALLI POLES TECHNOLOGY

ANTI RUST LIFETIME GUARANTEE NO PAINTING REQUIRED

MADE IN ITALY

ANTI CORROSION, UV-RAYS STABILIZED, NO MAINTENANCE, DOUBLE INSULATION, NOT AFFECTED BY CHEMICAL FERTILIZERS

ALOE'R/RUT (resin)



LED LAMP INCLUDED

6,5W FILAMENT 2700K	E26.163.F1R
8,5W CCT SET	E26.163.V1K
11W CCT SET	E26.163.T1K



Technical drawing showing a lamp with a height of 1500mm and a diameter of 190mm at the base.

ARTU'R/RUT



LED LAMP INCLUDED

6,5W FILAMENT 2700K	E26.158.F1R
8,5W CCT SET	E26.158.V1K
11W CCT SET	E26.158.T1K



Technical drawing showing a lamp with a height of 1920mm and a diameter of 245mm at the base.

GIGI/RUT



LED LAMP INCLUDED

6,5W FILAMENT 2700K	E26.156.F1R
8,5W CCT SET	E26.156.V1K
11W CCT SET	E26.156.T1K



Technical drawing showing a lamp with a height of 2130mm and a diameter of 245mm at the base.

RICU/RUT



LED LAMP INCLUDED

6,5W FILAMENT 2700K	E26.157.F1R
8,5W CCT SET	E26.157.V1K
11W CCT SET	E26.157.T1K



Technical drawing showing a lamp with a height of 2410mm and a diameter of 245mm at the base.

- 10 REVIVAL
- 36 GARDEN SMALL
- 52 GARDEN MEDIUM
- 72 GARDEN LARGE
- 88 HALF LANTERN
- 90 BOLLARD
- 96 BOLLARD
- 118 DOWNLIGHT
- 126 UP&DOWN
- 138 GARDEN MODERN FLOODLIGHT
- 148 IN-GROUND
- 154 BRICKLIGHT
- 164 BULKHEAD
- 183 POST
- 190 SOLAR MODERN
- 198 SOLAR CLASSIC
- 200 LAMPS

SALEM RANGE

MEDIUM SIZE

MADE IN ITALY



CCT SET		
6,5W 800 lm 2700 K	8,5W 920 lm 2700 K	11W 1200 lm 4000 K / 6500 K

More details at page 201

K26.111.F1R



SALEM RANGE

AVAILABLE COLORS				E27 CCT LED VERSION	E27 FILAMENT LED VERSION	E27 VERSION
RESIN BODY		DIFFUSER				
BLACK (A)	WHITE (W)	CLEAR (X)	OPAL (Y)	11W 1200 lm 100-240V 50/60 Hz 2700K/4000K/6500K CCT SET = 75W INCANDESCENT	6,5W 800 lm 100-240V 50/60 Hz 2700K = 60W INCANDESCENT	

BISSO/SALEM

IP55	6,5W 2700K FILAMENT	K26.131.F1R
	11W CCT SET	K26.131.T1K
	E27	K26.131.E27

Master box: **12pcs**

MINILOT/SALEM

6,5W 2700K FILAMENT	K26.111.F1R
11W CCT SET	K26.111.T1K
E27	K26.111.E27

IP55		
------	--	--

Master box: **12pcs**

SICHEM/SALEM

6,5W 2700K FILAMENT	K26.120.F1R
11W CCT SET	K26.120.T1K
E27	K26.120.E27

IP55		
------	--	--

Master box: **12pcs**

10	REVIVAL
36	GARDEN SMALL
52	GARDEN MEDIUM
72	GARDEN LARGE
88	HALF LANTERN
90	BOLLARD
96	BOLLARD
118	DOWNLIGHT
126	UP&DOWN
138	FLOODLIGHT
148	IN-GROUND
154	BRICKLIGHT
164	BULKHEAD
183	POST
190	SOLAR MODERN
198	SOLAR CLASSIC
200	LAMPS

SALEM RANGE

MEDIUM SIZE



AVAILABLE COLORS	
RESIN BODY	DIFFUSER
BLACK (A)	WHITE (W)
CLEAR (X)	OPAL (Y)

E27 CCT LED VERSION	
8,5W	11W
920 lm	1200 lm
100-240V	100-240V
50/60 Hz	50/60 Hz
2700K/4000K/6500K	2700K/4000K/6500K
60W INCANDESCENT	75W INCANDESCENT

E27 FILAMENT LED VERSION	
6,5W	6,5W
800 lm	800 lm
100-240V	100-240V
50/60 Hz	50/60 Hz
2700K	2700K
60W INCANDESCENT	60W INCANDESCENT

MIZAR/SALEM (resin)



LED LAMP INCLUDED

6,5W FILAMENT 2700K	K26.151.F1R
8,5W CCT SET	K26.151.V1K
11W CCT SET	K26.151.T1K

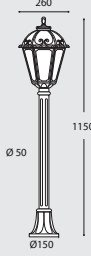

Dimensions: 260 (top width), 1150 (height), Ø50 (pole diameter), Ø150 (base diameter)

RICU BISSO/SALEM 2L



LED LAMP INCLUDED

6,5W FILAMENT 2700K	K26.157.S20.F1R
8,5W CCT SET	K26.157.S20.V1K
11W CCT SET	K26.157.S20.T1K



Dimensions: 690 (arm span), 2500 (height), Ø245 (pole diameter)

RICU BISSO/SALEM 3L



LED LAMP INCLUDED

6,5W FILAMENT 2700K	K26.157.S30.F1R
8,5W CCT SET	K26.157.S30.V1K
11W CCT SET	K26.157.S30.T1K

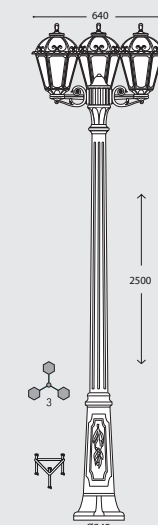

Dimensions: 640 (arm span), 2500 (height), Ø245 (pole diameter)



MEDIUM SIZE

SALEM RANGE

"METAL POST COVERED BY RESIN"



Labels: STEEL, RESIN, EXPANSE

fumaTech FUMAGALLI POLES TECHNOLOGY

LIFETIME GUARANTEE (ANTI RUST, NO PAINTING REQUIRED)

MADE IN ITALY

ANTI CORROSION, UV-RAYS STABILIZED, NO MAINTENANCE, DOUBLE INSULATION, NOT AFFECTED BY CHEMICAL FERTILIZERS

ALOE'.R/SALEM (resin)



LED LAMP INCLUDED

6,5W FILAMENT 2700K	K26.163.F1R
8,5W CCT SET	K26.163.V1K
11W CCT SET	K26.163.T1K



Dimensions: 260 (top width), 1500 (height), Ø190 (pole diameter)

ARTU'/SALEM



LED LAMP INCLUDED

6,5W FILAMENT 2700K	K26.158.F1R
8,5W CCT SET	K26.158.V1K
11W CCT SET	K26.158.T1K



Dimensions: 1920 (height), Ø245 (pole diameter)

GIGI/SALEM



LED LAMP INCLUDED

6,5W FILAMENT 2700K	K26.156.F1R
8,5W CCT SET	K26.156.V1K
11W CCT SET	K26.156.T1K



Dimensions: 260 (top width), 2130 (height), Ø245 (pole diameter)

RICU/SALEM



LED LAMP INCLUDED

6,5W FILAMENT 2700K	K26.157.F1R
8,5W CCT SET	K26.157.V1K
11W CCT SET	K26.157.T1K



Dimensions: 260 (top width), 2450 (height), Ø245 (pole diameter)

- 10 REVAL
- 36 GARDEN SMALL
- 52 GARDEN MEDIUM
- 72 GARDEN LARGE
- 88 HALF LANTERN
- 90 BOLLARD
- 96 BOLLARD
- 118 DOWNLIGHT
- 126 UP&DOWN
- 138 FLOODLIGHT
- 148 IN-GROUND
- 154 BRICKLIGHT
- 164 BULKHEAD
- 183 POST
- 190 SOLAR MODERN
- 198 SOLAR CLASSIC
- 200 LAMPS

GOLIA RANGE

MEDIUM SIZE



MADE IN ITALY

AVAILABLE COLORS		DIFFUSER	
RESIN BODY	DIFFUSER	CLEAR (X)	OPAL (Y)
BLACK (A)	WHITE (W)	CLEAR (X)	OPAL (Y)

E27 CCT LED VERSION			E27 FILAMENT LED VERSION			E27 VERSION		
6,5W	8,5W	11W	6,5W	8,5W	11W	60W	60W	60W
800 lm	920 lm	1200 lm	800 lm	920 lm	1200 lm			
2700 K	2700 K	4000 K	2700 K	2700 K	4000 K			

More details at page 201



Q23.131.F1R



AVAILABLE COLORS		E27 CCT LED VERSION		E27 FILAMENT LED VERSION		E27 VERSION	
RESIN BODY	DIFFUSER	E27 CCT LED VERSION		E27 FILAMENT LED VERSION		E27 VERSION	
BLACK (A)	WHITE (W)	DIFFUSER		DIFFUSER		DIFFUSER	
CLEAR (X)	OPAL (Y)	DIFFUSER		DIFFUSER		DIFFUSER	
BLACK (A)	WHITE (W)	CLEAR (X)	OPAL (Y)	CLEAR (X)	OPAL (Y)	CLEAR (X)	OPAL (Y)

E27 CCT LED VERSION		E27 FILAMENT LED VERSION		E27 VERSION	
6,5W	8,5W	6,5W	8,5W	60W	60W
920 lm	1200 lm	800 lm	920 lm		
100-240V	50/60 Hz	100-240V	50/60 Hz		
2700K/4000K/6500K		2700K			

BISSO/GOLIA

IP55	6,5W 2700K FILAMENT	Q23.131.F1R
	8,5W CCT SET	Q23.131.V1K
E27		Q23.131.E27

Master box: 12pcs

MINILOT/GOLIA		SICHEM/GOLIA	
6,5W 2700K FILAMENT	Q23.111.F1R	6,5W 2700K FILAMENT	Q23.120.F1R
8,5W CCT SET	Q23.111.V1K	8,5W CCT SET	Q23.120.V1K
E27	Q23.111.E27	E27	Q23.120.E27

Master box: 12pcs

Master box: 12pcs

GARDEN CLASSIC

- 10 REIVAL
- 36 GARDEN SMALL
- 52 GARDEN MEDIUM
- 72 GARDEN LARGE
- 88 HALF LANTERN
- 90 BOLLARD
- 96 BOLLARD
- 118 DOWNLIGHT
- 126 UP&DOWN

GARDEN MODERN

- 138 FLOODLIGHT
- 148 IN-GROUND
- 154 BRICKLIGHT
- 164 BULKHEAD
- 183 POST

SOLAR

- 190 SOLAR MODERN
- 198 SOLAR CLASSIC
- 200 LAMPS

GOLIA RANGE

MEDIUM SIZE



AVAILABLE COLORS			
RESIN BODY		DIFFUSER	
BLACK (A)	WHITE (W)	CLEAR (X)	OPAL (Y)

E27 CCT LED VERSION	
	8,5W 920 lm 100-240V 50/60 Hz 2700K/4000K/6500K CCT SET 60W INCANDESCENT

E27 FILAMENT LED VERSION	
	6,5W 800 lm 100-240V 50/60 Hz 2700K CCT SET 60W INCANDESCENT

MIZAR/GOLIA (resin)

IP55

6,5W FILAMENT	2700K	Q23.151.F1R
8,5W CCT SET		Q23.151.V1K



LED LAMP INCLUDED

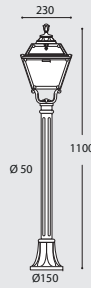

230
1100
Ø50
Ø150

RICU BISSO/GOLIA 2L

IP55

6,5W FILAMENT	2700K	Q23.157.S20.F1R
8,5W CCT SET		Q23.157.S20.V1K



LED LAMP INCLUDED



820
2430
Ø245

RICU BISSO/GOLIA 3L

IP55

6,5W FILAMENT	2700K	Q23.157.S30.F1R
8,5W CCT SET		Q23.157.S30.V1K



LED LAMP INCLUDED



770
2430
Ø245



MEDIUM SIZE

GOLIA RANGE

"METAL POST COVERED BY RESIN"



STEEL
RESIN
EXPANSE

fumaTech
FUMAGALLI POLES TECHNOLOGY

ANTI RUST
LIFETIME GUARANTEE
NO PAINTING REQUIRED
MADE IN ITALY

ANTI CORROSION
UV-RAYS STABILIZED
NO MAINTENANCE
DOUBLE INSULATION
NOT AFFECTED BY CHEMICAL FERTILIZERS

ALOE'R/GOLIA (resin)

IP55

6,5W FILAMENT	2700K	Q23.163.F1R
8,5W CCT SET		Q23.163.V1K



LED LAMP INCLUDED



230
1450
Ø190

ARTU'/GOLIA

IP55

6,5W FILAMENT	2700K	Q23.158.F1R
8,5W CCT SET		Q23.158.V1K



LED LAMP INCLUDED



1830
Ø245

GIGI/GOLIA

IP55

6,5W FILAMENT	2700K	Q23.156.F1R
8,5W CCT SET		Q23.156.V1K



LED LAMP INCLUDED



230
2110
Ø245

RICU/GOLIA

IP55

6,5W FILAMENT	2700K	Q23.157.F1R
8,5W CCT SET		Q23.157.V1K



LED LAMP INCLUDED



230
2380
Ø245

10	REIVAL
36	GARDEN SMALL
52	GARDEN MEDIUM
72	GARDEN LARGE
88	HALF LANTERN
90	BOLLARD
96	BOLLARD
118	DOWNLIGHT
126	UP&DOWN
138	FLOODLIGHT
148	IN-GROUND
154	BRICKLIGHT
164	BULKHEAD
183	POST
190	SOLAR MODERN
198	SOLAR CLASSIC
200	LAMPS

CEFA RANGE
MEDIUM SIZE

MADE IN ITALY



CCT SET		
6,5W 800 lm 2700 K	8,5W 920 lm 2700 K	11W 1200 lm 6500 K

More details at page 201



U23.120.F1R

UV TREATED	ANTI-SHOCK	RECYCLABLE	CE	CB ICEE CE SCHIME	IP55	CLASS II DOUBLE INSULATION



AVAILABLE COLORS				E27 CCT LED VERSION	E27 FILAMENT LED VERSION	E27 VERSION
RESIN BODY		DIFFUSER				
				8,5W 920 lm 100-240V 50/60 Hz 2700K/4000K/6500K	6,5W 800 lm 100-240V 50/60 Hz 2700K	60W INCANDESCENT
BLACK (A)	WHITE (W)	CLEAR (X)	OPAL (Y)			

BISSO/CEFA

	6,5W FILAMENT 2700K	U23.131.F1R
	8,5W CCT SET	U23.131.V1K
E27		U23.131.E27

Master box: **12pcs**

MINILOT/CEFA

	6,5W FILAMENT 2700K	U23.111.F1R
	8,5W CCT SET	U23.111.V1K
E27		U23.111.E27

Master box: **12pcs**

SICHEM/CEFA

	6,5W FILAMENT 2700K	U23.120.F1R
	8,5W CCT SET	U23.120.V1K
E27		U23.120.E27

Master box: **12pcs**

10	REVIVAL
36	GARDEN SMALL
52	GARDEN MEDIUM
72	GARDEN LARGE
88	HALF LANTERN
90	BOLLARD
96	BOLLARD
118	DOWNLIGHT
126	UP&DOWN
138	FLOODLIGHT
148	IN-GROUND
154	BRICKLIGHT
164	BULKHEAD
183	POST
190	SOLAR MODERN
198	SOLAR CLASSIC
200	LAMPS

CEFA RANGE

MEDIUM SIZE



AVAILABLE COLORS			
RESIN BODY		DIFFUSER	
BLACK (A)	WHITE (W)	CLEAR (X)	OPAL (Y)

E27 CCT LED VERSION	
	8,5W 920 lm 100-240V 50/60 Hz 2700K/4000K/6500K CCT SET 60W INCANDESCENT

E27 FILAMENT LED VERSION	
	6,5W 800 lm 100-240V 50/60 Hz 2700K CCT SET 60W INCANDESCENT

MIZAR/CEFA (resin)

LED LAMP INCLUDED

6,5W FILAMENT	2700K	U23.151.F1R
8,5W CCT SET		U23.151.V1K

Dimensions: 230 (width), 1110 (height), Ø50 (pole), Ø150 (base)

RICU BISSO/CEFA 2L

LED LAMP INCLUDED

6,5W FILAMENT	2700K	U23.157.S20.F1R
8,5W CCT SET		U23.157.S20.V1K

Dimensions: 820 (width), 2450 (height), Ø245 (base)

RICU BISSO/CEFA 3L

LED LAMP INCLUDED

6,5W FILAMENT	2700K	U23.157.S30.F1R
8,5W CCT SET		U23.157.S30.V1K

Dimensions: 770 (width), 2450 (height), Ø245 (base)



MEDIUM SIZE

CEFA RANGE

"METAL POST COVERED BY RESIN"

Labels: STEEL, RESIN, EXPANSE

fumaTech FUMAGALLI POLES TECHNOLOGY

LIFETIME GUARANTEE (ANTI RUST, NO PAINTING REQUIRED)

MADE IN ITALY

ANTI CORROSION, UV-RAYS STABILIZED, NO MAINTENANCE, DOUBLE INSULATION, NOT AFFECTED BY CHEMICAL FERTILIZES

ALOE'R/CEFA (resin)

LED LAMP INCLUDED

6,5W FILAMENT	2700K	U23.163.F1R
8,5W CCT SET		U23.163.V1K

Dimensions: 230 (width), 1470 (height), Ø190 (base)

ARTU'/CEFA

LED LAMP INCLUDED

6,5W FILAMENT	2700K	U23.158.F1R
8,5W CCT SET		U23.158.V1K

Dimensions: 230 (width), 1865 (height), Ø245 (base)

GIGI/CEFA

LED LAMP INCLUDED

6,5W FILAMENT	2700K	U23.156.F1R
8,5W CCT SET		U23.156.V1K

Dimensions: 230 (width), 2130 (height), Ø245 (base)

RICU/CEFA

LED LAMP INCLUDED

6,5W FILAMENT	2700K	U23.157.F1R
8,5W CCT SET		U23.157.V1K

Dimensions: 230 (width), 2450 (height), Ø245 (base)

- 10 REVAL
- 36 GARDEN SMALL
- 52 GARDEN MEDIUM
- 72 GARDEN LARGE
- 88 HALF LANTERN
- 90 BOLLARD
- 96 BOLLARD
- 118 DOWNLIGHT
- 126 UP&DOWN
- 138 FLOODLIGHT
- 148 IN-GROUND
- 154 BRICKLIGHT
- 164 BULKHEAD
- 183 POST
- 190 SOLAR MODERN
- 198 SOLAR CLASSIC
- 200 LAMPS

GLOBE 300 CLASSIC

MEDIUM SIZE



MADE IN ITALY

CCT SET		
6,5W 800 lm 2700 K	8,5W 920 lm 2700 K	11W 1200 lm 4000 K / 6500 K

More details at page 201



G30.111.E27



G30.162.V1K



AVAILABLE COLORS		E27 CCT LED VERSION	E27 FILAMENT LED VERSION	E27 VERSION
RESIN BODY	DIFFUSER			
BLACK (A) WHITE (W)	CLEAR (X) OPAL (Y) SMOKED (Z)	11W 1200 lm 100-240V 50/60 Hz 2700K/4000K/6500K	6,5W 800 lm 100-240V 50/60 Hz 2700K	
		75W INCANDESCENT	60W INCANDESCENT	

BISSO/G300

IP55	6,5W FILAMENT 2700K	G30.131.F1R
	11W CCT SET	G30.131.T1K
	E27	G30.131.E27

Master box: 24pcs

MINILOT/G300		SICHEM/G300	
6,5W FILAMENT 2700K	G30.111.F1R	6,5W FILAMENT 2700K	G30.120.F1R
11W CCT SET	G30.111.T1K	11W CCT SET	G30.120.T1K
E27	G30.111.E27	E27	G30.120.E27

Master box: 24pcs

Master box: 24pcs

- 10 REVIVAL
- 36 GARDEN SMALL
- 52 GARDEN MEDIUM
- 72 GARDEN LARGE
- 88 HALF LANTERN
- 90 BOLLARD
- 96 BOLLARD
- 118 DOWNLIGHT
- 126 UP&DOWN
- 138 FLOODLIGHT
- 148 IN-GROUND
- 154 BRICKLIGHT
- 164 BULKHEAD
- 183 POST
- 190 SOLAR MODERN
- 198 SOLAR CLASSIC
- 200 LAMPS

GLOBE 300 CLASSIC MEDIUM SIZE



AVAILABLE COLORS

RESIN BODY		DIFFUSER		
BLACK (A)	WHITE (W)	CLEAR (X)	OPAL (Y)	SMOKED (Z)

E27 CCT LED VERSION

8,5W	11W
920 lm	1200 lm
100-240V	100-240V
50/60 Hz	50/60 Hz
2700K/4000K/6500K	2700K/4000K/6500K
60W INCANDESCENT	75W INCANDESCENT

E27 FILAMENT LED VERSION

6,5W	800 lm
100-240V	100-240V
50/60 Hz	50/60 Hz
2700K	2700K
60W INCANDESCENT	

IAFET.R/G300 (resin)



IP55

6,5W 2700K FILAMENT	G30.162.F1R
8,5W CCT SET	G30.162.V1K
11W CCT SET	G30.162.T1K

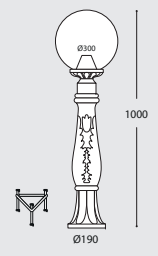

Master box: **2pcs**



MEDIUM SIZE GLOBE 300 CLASSIC

"METAL POST COVERED BY RESIN"



STEEL
RESIN
EXPANSE

fumaTech
FUMAGALLI POLES TECHNOLOGY

LIFETIME GUARANTEE
ANTI RUST
NO PAINTING REQUIRED

MADE IN ITALY

ANTI CORROSION
UV-RAYS STABILIZED
NO MAINTENANCE
DOUBLE INSULATION
NOT AFFECTED BY CHEMICAL FERTILIZERS

ALOE'.R/G300 (resin)



IP55

6,5W 2700K FILAMENT	G30.163.F1R
8,5W CCT SET	G30.163.V1K
11W CCT SET	G30.163.T1K

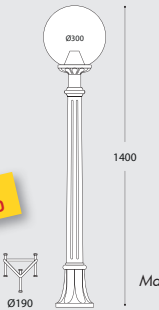

Master box: **2pcs**

ARTU'/G300



IP55

6,5W 2700K FILAMENT	G30.158.F1R
8,5W CCT SET	G30.158.V1K
11W CCT SET	G30.158.T1K

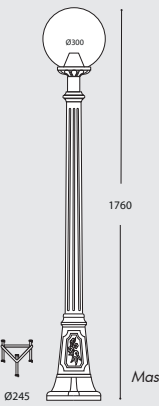

Master box: **2pcs**

RICU BISSO/G300 2L



IP55

6,5W 2700K FILAMENT	G30.157.S20.F1R
8,5W CCT SET	G30.157.S20.V1K
11W CCT SET	G30.157.S20.T1K



Master box: **2pcs**

RICU BISSO/G300 3L



IP55

6,5W 2700K FILAMENT	G30.157.S30.F1R
8,5W CCT SET	G30.157.S30.V1K
11W CCT SET	G30.157.S30.T1K



Master box: **2pcs**

GIGI/G300

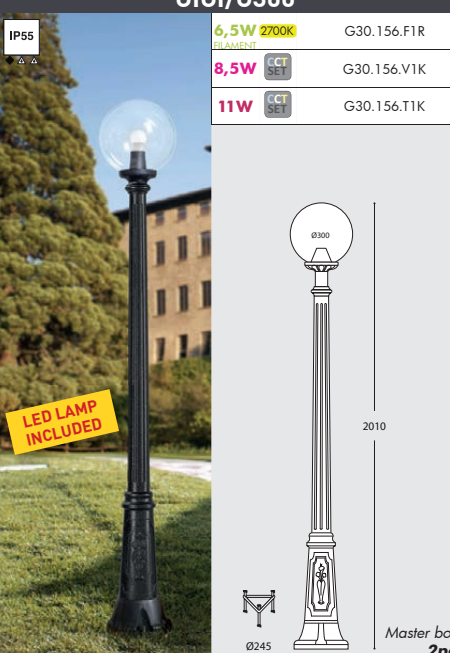

IP55

6,5W 2700K FILAMENT	G30.156.F1R
8,5W CCT SET	G30.156.V1K
11W CCT SET	G30.156.T1K

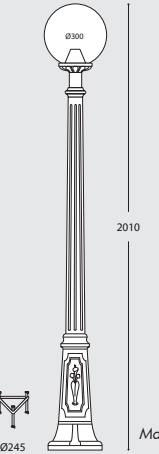

Master box: **2pcs**

RICU/G300



IP55

6,5W 2700K FILAMENT	G30.157.F1R
8,5W CCT SET	G30.157.V1K
11W CCT SET	G30.157.T1K

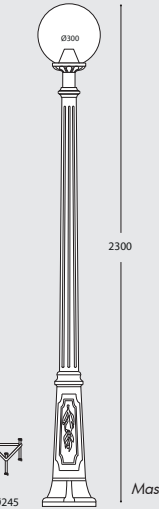

Master box: **2pcs**

- 10 REVAL
- 36 GARDEN SMALL
- 52 GARDEN MEDIUM
- 72 GARDEN LARGE
- 88 HALF LANTERN
- 90 BOLLARD
- 96 BOLLARD
- 118 DOWNLIGHT
- 126 UP&DOWN
- 138 GARDEN MODERN FLOODLIGHT
- 148 IN-GROUND
- 154 BRICKLIGHT
- 164 BULKHEAD
- 183 POST
- 190 SOLAR MODERN
- 198 SOLAR CLASSIC
- 200 LAMPS

NOEMI RANGE

LARGE SIZE



MADE IN ITALY



HIGH POWER LED VERSION

E35.132.Q1K

E27 HIGH POWER LED

INDOOR & OUTDOOR USE

+80°C
-30°C
90% HUMIDITY
VOLTAGE SURGE RESISTANT

15W (1690 lm)
30W (3620 lm)
50W (6550 lm)

More details at page 202.



LARGE SIZE

NOEMI RANGE

AVAILABLE COLORS

RESIN BODY		DIFFUSER	
BLACK (A)	WHITE (W)	CLEAR (X)	OPAL (Y)

E27 HIGH POWER LED VERSION

15W	30W
1690 lm	3620 lm
100-240V 50/60 Hz	100-240V 50/60 Hz
4000K/3000K	4000K/3000K
= NOEMI 100W INCANDESCENT	= NOEMI 70W HQI-SOY

OFIR/NOEMI

15W LED CCT SET	E35.132.R1K
30W LED CCT SET	E35.132.Q1K

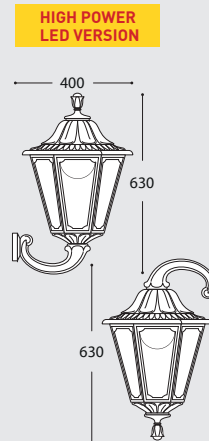

LOT/NOEMI		SICHEM/NOEMI	
15W LED CCT SET	E35.113.R1K	15W LED CCT SET	E35.121.R1K
30W LED CCT SET	E35.113.Q1K	30W LED CCT SET	E35.121.Q1K

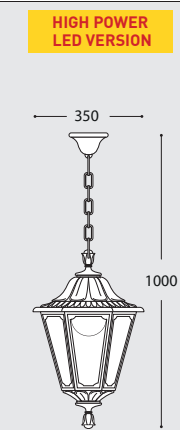
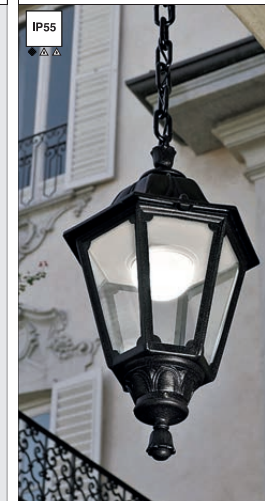
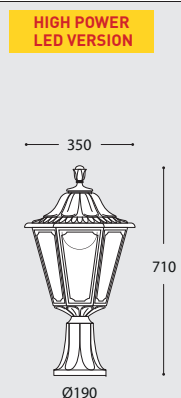

GARDEN CLASSIC

- 10 REIVAL
- 36 GARDEN SMALL
- 52 GARDEN MEDIUM
- 72 GARDEN LARGE
- 88 HALF LANTERN
- 90 BOLLARD
- 96 BOLLARD
- 118 DOWNLIGHT
- 126 UP&DOWN

GARDEN MODERN

- 138 FLOODLIGHT
- 148 IN-GROUND
- 154 BRICKLIGHT
- 164 BULKHEAD
- 183 POST

SOLAR

- 190 SOLAR MODERN
- 198 SOLAR CLASSIC
- 200 LAMPS

NOEMI RANGE

LARGE SIZE

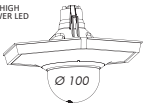

E27 HIGH POWER LED VERSION					
LAMP	POWER	LUMINOUS FLUX	VOLTAGE RANGE	CCT SETTABLE	COMPARISON
 E27 HIGH POWER LED Ø 100	15W	1690 lm	100-240V 50/60 Hz	4000K/3000K	= NOEMI = 100W INCANDESCENT
	30W	3620 lm	100-240V 50/60 Hz	4000K/3000K	= NOEMI = 70W HID-SON

IAFET.R/NOEMI (resin)

IP55

15W LED	CCT SET	E35.162.R1K
30W LED	CCT SET	E35.162.Q1K

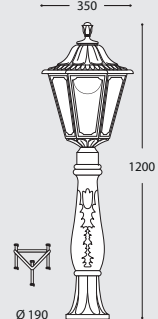
HIGH POWER LED VERSION

Master box: **2pcs**

ARTU'/NOEMI	GIGI/NOEMI	RICU/NOEMI
15W LED	15W LED	15W LED
CCT SET	CCT SET	CCT SET
E35.158.R1K	E35.156.R1K	E35.157.R1K
30W LED	30W LED	30W LED
CCT SET	CCT SET	CCT SET
E35.158.Q1K	E35.156.Q1K	E35.157.Q1K

HIGH POWER LED VERSION

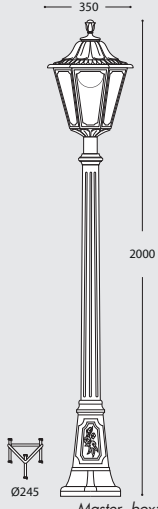
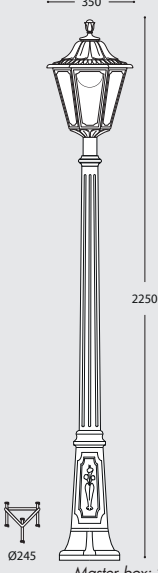
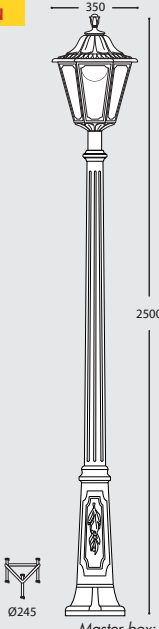
Master box: **2pcs**



LARGE SIZE

NOEMI RANGE

"METAL POST COVERED BY RESIN"

STEEL
RESIN
EXPANSE

ANTI RUST
LIFETIME GUARANTEE
NO PAINTING REQUIRED



MADE IN ITALY

ANTI CORROSION
UV-RAYS STABILIZED
NO MAINTENANCE
DOUBLE INSULATION
NOT AFFECTED BY CHEMICAL FERTILIZES

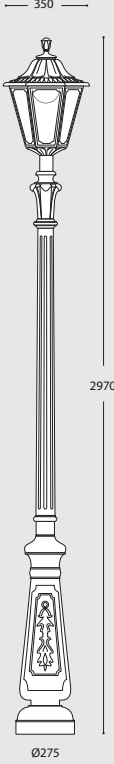

NEBO/NOEMI	NEBO OFIR/NOEMI 2L
30W LED	30W LED
CCT SET	CCT SET
E35.201.Q1K	E35.201.R20.Q1K

IP55

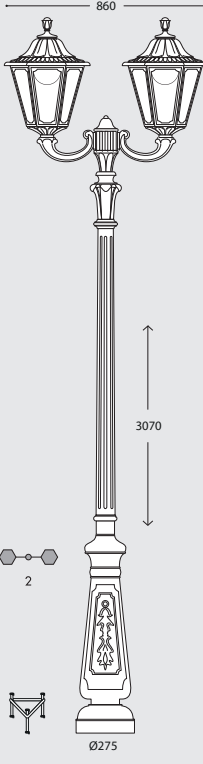
HIGH POWER LED VERSION

Master box: **2pcs**

MADE IN ITALY

- 10 REIVAL
- 36 GARDEN SMALL
- 52 GARDEN MEDIUM
- 72 GARDEN LARGE
- 88 HALF LANTERN
- 90 BOLLARD
- 96 BOLLARD
- 118 DOWNLIGHT
- 126 UP&DOWN
- 138 FLOODLIGHT
- 148 IN-GROUND
- 154 BRICKLIGHT
- 164 BULKHEAD
- 183 POST
- 190 SOLAR MODERN
- 198 SOLAR CLASSIC
- 200 LAMPS

SILOE RANGE
LARGE SIZE



MADE IN ITALY

HIGH POWER LED VERSION



K35.132.Q1K

E27 HIGH POWER LED

INDOOR & OUTDOOR USE

+80°C -30°C 90% HUMIDITY

VOLTAGE SURGE RESISTANT

15W (1690 lm)
30W (3620 lm)
50W (6550 lm)



More details at page 202



LARGE SIZE

SILOE RANGE

AVAILABLE COLORS

RESIN BODY		DIFFUSER	
BLACK (A)	WHITE (W)	CLEAR (X)	OPAL (Y)

E27 HIGH POWER LED VERSION

15W	30W
1690 lm	3620 lm
100-240V 50/60 Hz	100-240V 50/60 Hz
4000K/3000K	4000K/3000K
= SILOE 100W INCANDESCENT	= SILOE 70W HQI-SOY

OFIR/SILOE

15W LED CCT SET	K35.132.R1K
30W LED CCT SET	K35.132.Q1K

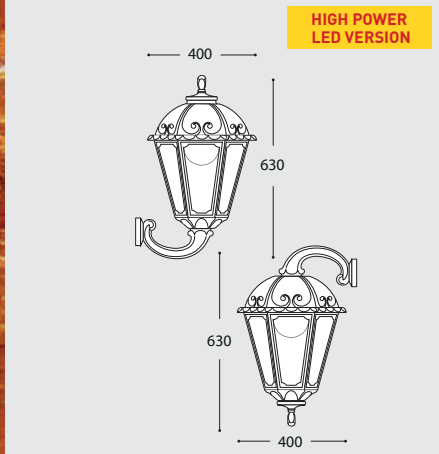

LOT/SILOE		SICHEM/SILOE	
15W LED CCT SET	K35.113.R1K	15W LED CCT SET	K35.121.R1K
30W LED CCT SET	K35.113.Q1K	30W LED CCT SET	K35.121.Q1K

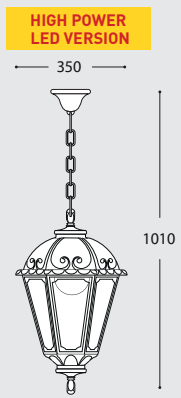
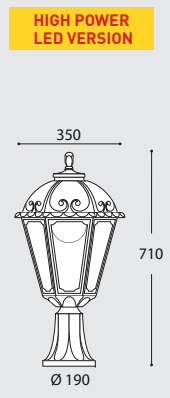

- 10 REVAL
- 36 GARDEN SMALL
- 52 GARDEN MEDIUM
- 72 GARDEN LARGE
- 88 HALF LANTERN
- 90 BOLLARD
- 96 BOLLARD
- 118 DOWNLIGHT
- 126 UP&DOWN
- 138 FLOODLIGHT
- 148 IN-GROUND
- 154 BRICKLIGHT
- 164 BULKHEAD
- 183 POST
- 190 SOLAR MODERN
- 198 SOLAR CLASSIC
- 200 LAMPS

SILOE RANGE

LARGE SIZE

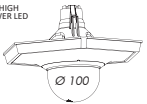

E27 HIGH POWER LED VERSION					
LAMP	POWER	LUMINOUS FLUX UP TO	VOLTAGE RANGE	CCT SETTABLE	COMPARISON
 E27 HIGH POWER LED Ø 100	15W	1690 lm	100-240V 50/60 Hz	4000K/3000K	= SILOE 100W INCANDESCENT
	30W	3620 lm	100-240V 50/60 Hz	4000K/3000K	= SILOE 70W HID-SON



IAFET.R/SILOE (resin)



IP55

15W LED		K35.162.R1K
30W LED		K35.162.Q1K

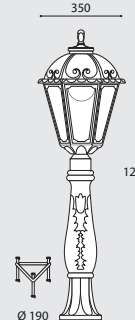

HIGH POWER LED VERSION

Master box: **2pcs**

ARTU'/SILOE

GIGI/SILOE

RICU/SILOE

IP55

15W LED		K35.158.R1K
30W LED		K35.158.Q1K

15W LED		K35.156.R1K
30W LED		K35.156.Q1K

15W LED		K35.157.R1K
30W LED		K35.157.Q1K

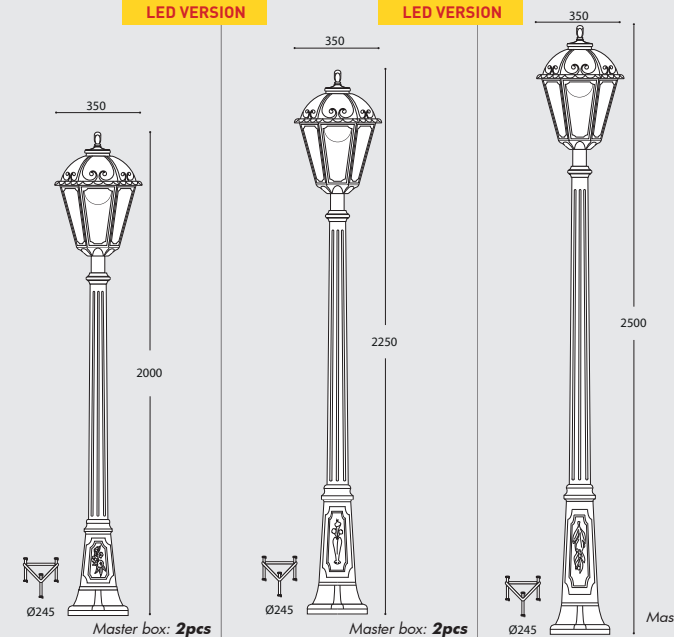

HIGH POWER LED VERSION

Master box: **2pcs**



LARGE SIZE

SILOE RANGE

"METAL POST COVERED BY RESIN"



STEEL
RESIN
EXPANSE

ANTI RUST LIFETIME GUARANTEE
NO PAINTING REQUIRED

MADE IN ITALY

ANTI CORROSION

UV-RAYS STABILIZED

NO MAINTENANCE

DOUBLE INSULATION

NOT AFFECTED BY CHEMICAL FERTILIZERS

NEBO/SILOE

NEBO OFIR/SILOE 2L

IP55

30W LED		K35.201.Q1K
----------------	--	-------------

IP55

30W LED		K35.201.R20.Q1K
----------------	--	-----------------

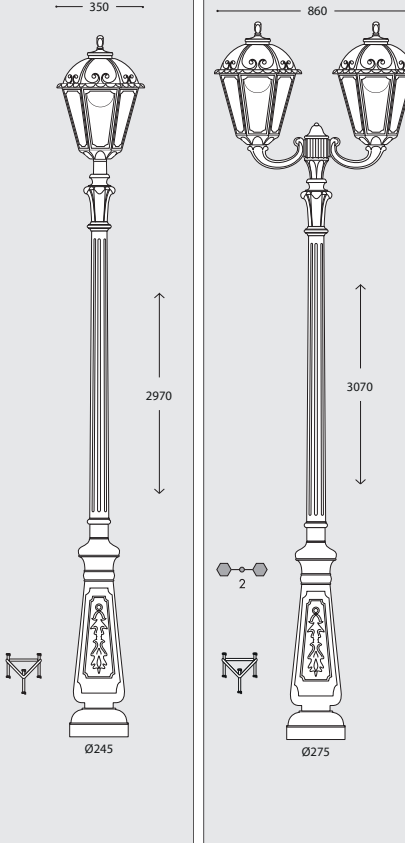

HIGH POWER LED VERSION

- 10 REVAL
- 36 GARDEN SMALL
- 52 GARDEN MEDIUM
- 72 GARDEN LARGE
- 88 HALF LANTERN
- 90 BOLLARD
- 96 BOLLARD
- 118 DOWNLIGHT
- 126 UP&DOWN
- 138 FLOODLIGHT
- 148 IN-GROUND
- 154 BRICKLIGHT
- 164 BULKHEAD
- 183 POST
- 190 SOLAR MODERN
- 198 SOLAR CLASSIC
- 200 LAMPS

TOBIA RANGE

LARGE SIZE



HIGH POWER LED VERSION

MADE IN ITALY

E27 HIGH POWER LED

INDOOR & OUTDOOR USE

+80°C 90% HUMIDITY
-30°C

VOLTAGE SURGE RESISTANT

15W (1690 lm)
30W (3620 lm)
50W (6550 lm)

More details at page 202



Q33.113.Q1K



LARGE SIZE

TOBIA RANGE

AVAILABLE COLORS	
RESIN BODY	DIFFUSER
BLACK (A)	WHITE (W)
CLEAR (X)	OPAL (Y)

E27 HIGH POWER LED VERSION	
15W 1690 lm	30W 3620 lm
100-240V 50/60 Hz	100-240V 50/60 Hz
4000K/3000K	4000K/3000K
= TOBIA 100W INCANDESCENT	= TOBIA 70W HI-SOON

OFIR/TOBIA	
15W LED CCT SET	Q33.132.R1K
30W LED CCT SET	Q33.132.Q1K

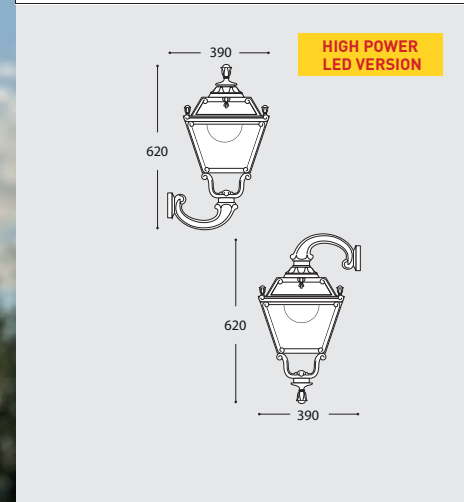

LOT/TOBIA	
15W LED CCT SET	Q33.113.R1K
30W LED CCT SET	Q33.113.Q1K



SICHEM/TOBIA	
15W LED CCT SET	Q33.121.R1K
30W LED CCT SET	Q33.121.Q1K



10	RENOVATION
36	GARDEN SMALL
52	GARDEN MEDIUM
72	GARDEN LARGE
88	HALF LANTERN
90	BOLLARD
96	BOLLARD
118	DOWNLIGHT
126	UP&DOWN
138	FLOODLIGHT
148	IN-GROUND
154	BRICKLIGHT
164	BULKHEAD
183	POST
190	SOLAR MODERN
198	SOLAR CLASSIC
200	LAMPS

TOBIA RANGE

LARGE SIZE

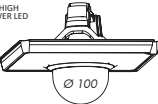

E27 HIGH POWER LED VERSION					
LAMP	POWER	LUMINOUS FLUX UP TO	VOLTAGE RANGE	CCT SETTABLE	COMPARISON
 E27 HIGH POWER LED Ø 100	15W	1690 lm	100-240V 50/60 Hz	4000K/3000K	= TOBIA 100W INCANDESCENT
	30W	3620 lm	100-240V 50/60 Hz	4000K/3000K	= TOBIA 70W HIG-SON

IAFET.R/TOBIA (resin)



IP55

15W LED	CCT SET	Q33.162.R1K
30W LED	CCT SET	Q33.162.Q1K

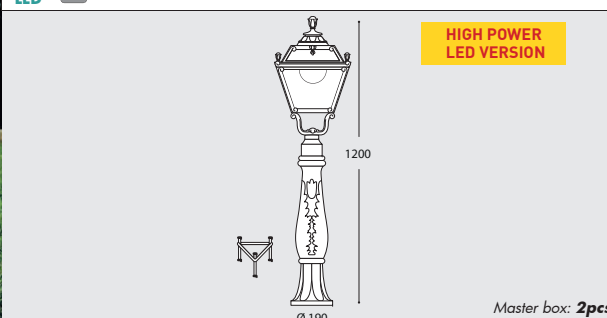

HIGH POWER LED VERSION

Master box: **2pcs**



IP55

ARTU'/TOBIA			GIGI/TOBIA			RICU/TOBIA		
15W LED	CCT SET	Q33.158.R1K	15W LED	CCT SET	Q33.156.R1K	15W LED	CCT SET	Q33.157.R1K
30W LED	CCT SET	Q33.158.Q1K	30W LED	CCT SET	Q33.156.Q1K	30W LED	CCT SET	Q33.157.Q1K

HIGH POWER LED VERSION

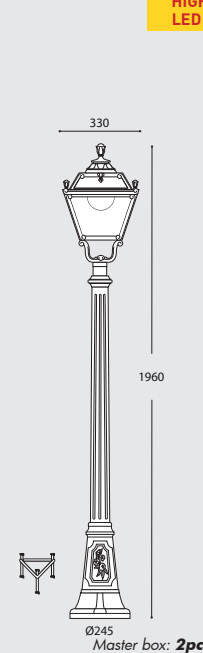

Master box: **2pcs**

HIGH POWER LED VERSION

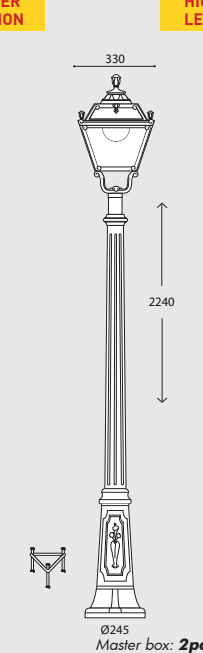

Master box: **2pcs**

HIGH POWER LED VERSION

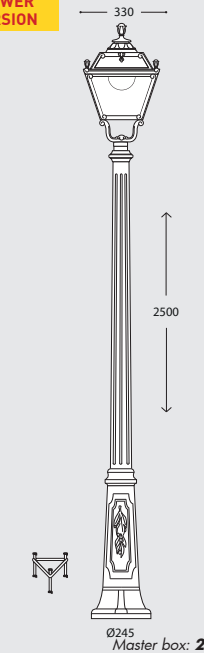

Master box: **2pcs**



LARGE SIZE

TOBIA RANGE

"METAL POST COVERED BY RESIN"



STEEL
RESIN
EXPANSE

fumaTech
FUMAGALLI POLES TECHNOLOGY

ANTI RUST
LIFETIME GUARANTEE
NO PAINTING REQUIRED

MADE IN ITALY

ANTI CORROSION | UV-RAYS STABILIZED | NO MAINTENANCE | DOUBLE INSULATION | NOT AFFECTED BY CHEMICAL FERTILIZES

NEBO/TOBIA

30W LED	CCT SET	Q33.201.Q1K
----------------	---------	-------------

IP55



HIGH POWER LED VERSION

NEBO OFIR/TOBIA 2L

30W LED	CCT SET	Q33.201.R20.Q1K
----------------	---------	-----------------

IP55



HIGH POWER LED VERSION

- 10 REIVAL
- 36 GARDEN SMALL
- 52 GARDEN MEDIUM
- 72 GARDEN LARGE
- 88 HALF LANTERN
- 90 BOLLARD
- 96 BOLLARD
- 118 DOWNLIGHT
- 126 UP&DOWN
- 138 FLOODLIGHT
- 148 IN-GROUND
- 154 BRICKLIGHT
- 164 BULKHEAD
- 183 POST
- 190 SOLAR MODERN
- 198 SOLAR CLASSIC
- 200 LAMPS

SIMON RANGE

LARGE SIZE



MADE IN ITALY

HIGH POWER LED VERSION

U33.132.Q1K

E27 HIGH POWER LED

INDOOR & OUTDOOR USE

+80°C
-30°C

90% HUMIDITY

VOLTAGE SURGE RESISTANT

15W (1690 lm)
30W (3620 lm)
50W (6550 lm)



More details at page 202



LARGE SIZE

SIMON RANGE

AVAILABLE COLORS

RESIN BODY		DIFFUSER	
BLACK (A)	WHITE (W)	CLEAR (X)	OPAL (Y)

E27 HIGH POWER LED VERSION

15W	30W
1690 lm	3620 lm
100-240V 50/60 Hz	100-240V 50/60 Hz
4000K/3000K	4000K/3000K
= SIMON 100W INCANDESCENT	= SIMON 70W INCANDESCENT

OFIR/SIMON

15W LED	CCT SET	U33.132.R1K
30W LED	CCT SET	U33.132.Q1K

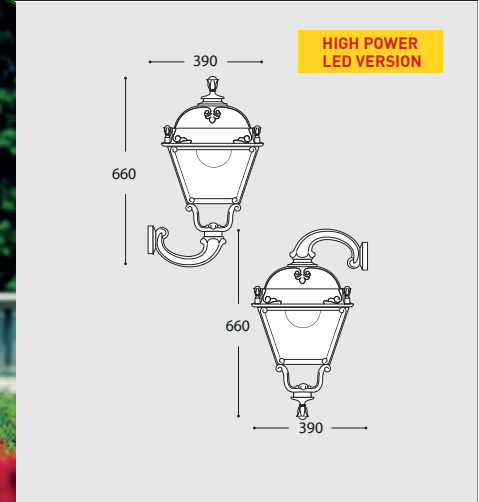

LOT/SIMON

15W LED	CCT SET	U33.113.R1K
30W LED	CCT SET	U33.113.Q1K



SICHEM/SIMON

15W LED	CCT SET	U33.121.R1K
30W LED	CCT SET	U33.121.Q1K



- 10 REVAL
- 36 GARDEN SMALL
- 52 GARDEN MEDIUM
- 72 GARDEN LARGE
- 88 HALF LANTERN
- 90 BOLLARD
- 96 BOLLARD
- 118 DOWNLIGHT
- 126 UP&DOWN
- 138 FLOODLIGHT
- 148 IN-GROUND
- 154 BRICKHEAD
- 164 BULKHEAD
- 183 POST
- 190 SOLAR MODERN
- 198 SOLAR CLASSIC
- 200 LAMPS

SIMON RANGE

LARGE SIZE

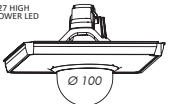

E27 HIGH POWER LED VERSION					
LAMP	POWER	LUMINOUS FLUX UP TO	VOLTAGE RANGE	CCT SETTABLE	COMPARISON
 E27 HIGH POWER LED Ø 100	15W	1690 lm	100-240V 50/60 Hz	4000K/3000K	= SIMON 100W INCANDESCENT
	30W	3620 lm	100-240V 50/60 Hz	4000K/3000K	= SIMON 70W HID-SON

IAFET.R/SIMON (resin)

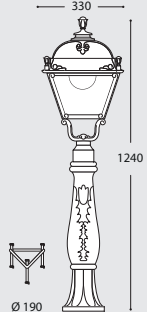

15W LED CCT SET U33.162.R1K	 1240 Ø 190 HIGH POWER LED VERSION
30W LED CCT SET U33.162.Q1K	

Master box: 2pcs

ARTU'/SIMON	GIGI/SIMON	RICU/SIMON
15W LED CCT SET U33.158.R1K	15W LED CCT SET U33.156.R1K	15W LED CCT SET U33.157.R1K
30W LED CCT SET U33.158.Q1K	30W LED CCT SET U33.156.Q1K	30W LED CCT SET U33.157.Q1K

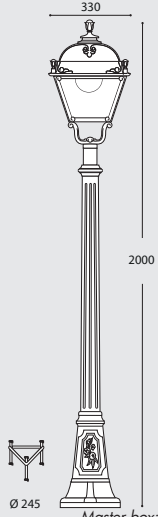
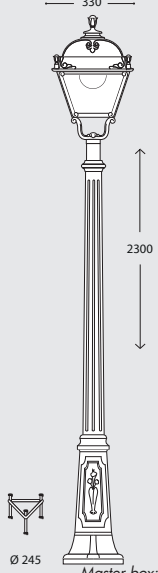
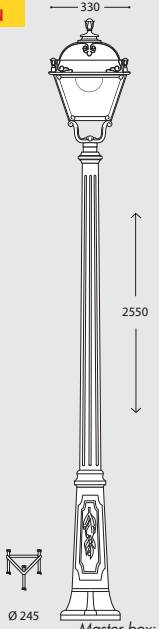
Master box: 2pcs



LARGE SIZE

SIMON RANGE

"METAL POST COVERED BY RESIN"



STEEL
RESIN
EXPANSE

ANTI RUST LIFETIME GUARANTEE NO PAINTING REQUIRED
MADE IN ITALY

ANTI CORROSION
UV-RAYS STABILIZED
NO MAINTENANCE
DOUBLE INSULATION
NOT AFFECTED BY CHEMICAL FERTILIZES

NEBO/SIMON	NEBO OFIR/SIMON 2L
30W LED CCT SET U33.201.Q1K	30W LED CCT SET U33.201.R20.Q1K

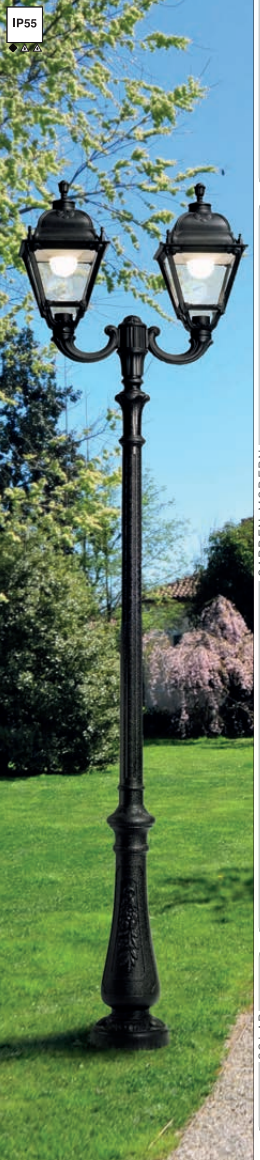
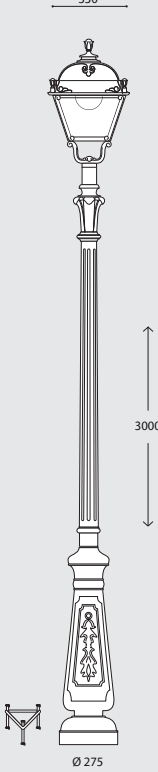
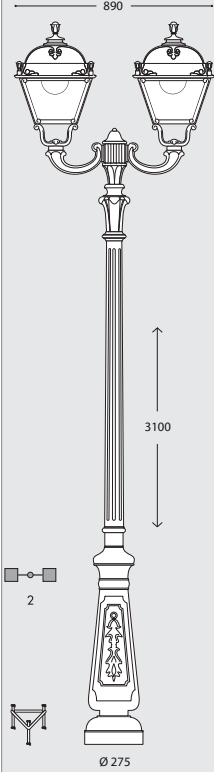
Master box: 2pcs

- 10 REVAL
- 36 GARDEN SMALL
- 52 GARDEN MEDIUM
- 72 GARDEN LARGE
- 88 HALF LANTERN
- 90 BOLLARD
- 96 BOLLARD
- 118 DOWNLIGHT
- 126 UP&DOWN
- 138 FLOODLIGHT
- 148 IN-GROUND
- 154 BRICKLIGHT
- 164 BULKHEAD
- 183 POST
- 190 SOLAR MODERN
- 198 SOLAR CLASSIC
- 200 LAMPS

IESSE-DARIA

HALF LANTERN



MADE IN ITALY



M22.000.F1R

CCT SET		
6,5W 800 lm 2700 K	8,5W 920 lm 4000 K	11W 1200 lm 6500 K

More details at page 201

SMART PACK AVAILABLE

SINGLE BOX	NEW SMART PACK *
	<ul style="list-style-type: none"> Save 44% volume ECO-friendly packaging Film wrapped items
cbm: 0,22 Master box: 16 pcs	<p>SAVE 44% VOLUME</p> <p>cbm: 0,14 Master box: 18 pcs</p>



AVAILABLE COLORS		E27 CCT LED VERSION		E27 FILAMENT LED		E27 VERSION	
RESIN BODY	DIFFUSER	8,5W 920 lm 100-240V 50/60 Hz 2700K/4000K/6500K 60W INCANDESCENT	11W 1200 lm 100-240V 50/60 Hz 2700K/4000K/6500K 75W INCANDESCENT	6,5W 800 lm 100-240V 50/60 Hz 2700K 60W INCANDESCENT	8,5W 920 lm 100-240V 50/60 Hz 2700K/4000K/6500K 75W INCANDESCENT	11W 1200 lm 100-240V 50/60 Hz 2700K/4000K/6500K 75W INCANDESCENT	6,5W 800 lm 100-240V 50/60 Hz 2700K 60W INCANDESCENT
BLACK (A) WHITE (W)	CLEAR (X) OPAL (Y)						

IESSE

IP55	6,5W FILAMENT 2700K	M22.000.F1R	SINGLE BOX
	8,5W CCT SET	M22.000.V1K	SINGLE BOX
	E27	M22.000.E27	SINGLE BOX

Standard Master box: 16pcs
Smart pack Master box: 18pcs

DARIA

IP55	6,5W FILAMENT 2700K	M28.000.F1R
	11W CCT SET	M28.000.T1K
	E27	M28.000.E27

- 10 REVAL
- 36 GARDEN SMALL
- 52 GARDEN MEDIUM
- 72 GARDEN LARGE
- 88 HALF LANTERN
- 90 BOLLARD
- 96 BOLLARD
- 118 DOWNLIGHT
- 126 UP&DOWN
- 138 FLOODLIGHT
- 148 IN-GROUND
- 154 BRICKLIGHT
- 164 BULKHEAD
- 183 POST
- 190 SOLAR MODERN
- 198 SOLAR CLASSIC
- 200 LAMPS

SAURO
BOLLARD



MADE IN ITALY



D15.554.E27FRA



SAURO E27 VERSIONS

 FRA	with white resin louvre	 FCI	with aluminium chrome louvre
---------	-------------------------	---------	------------------------------

SAURO E27

AVAILABLE COLORS

RESIN BODY (MOULDED COLOURS)			DIFFUSER	
BLACK (A) 	GREY (L) 	WHITE (W) 	CLEAR (X) 	OPAL (Y)

SAURO 1100

E27 D15.555.E27

SAURO 800

E27 D15.554.E27

SAURO 500

E27 D15.553.E27

MIRELLA

E27 D15.505.E27

GARDEN CLASSIC

- 10 REVIVAL
- 36 GARDEN SMALL
- 52 GARDEN MEDIUM
- 72 GARDEN LARGE
- 88 HALF LANTERN
- 90 BOLLARD
- 96 BOLLARD
- 118 DOWNLIGHT
- 126 UP&DOWN

GARDEN MODERN

- 138 FLOODLIGHT
- 148 IN-GROUND
- 154 BRICKLIGHT
- 164 BULKHEAD
- 183 POST

SOLAR

- 190 SOLAR MODERN
- 198 SOLAR CLASSIC
- 200 LAMPS

SAURO
BOLLARD



MADE IN ITALY

D15.554.D1KCRB



CCT SETTABLE

SDCM <6

3000 K 4000 K 6500 K

UV TREATED ANTI SHOCK RECYCLABLE CE CB IEC 60598 IP55 CLASS II DOUBLE INSULATION



SAURO GX53

SAURO LED VERSIONS

LAMP	POWER	LUMINOUS FLUX (Φ TOTAL)	VOLTAGE RANGE	CCT SETTABLE	
	10W	1290 lm	100-240V 50/60 Hz	6500K/4000K/3000K	=100W INCANDESCENT

AVAILABLE COLORS

RESIN BODY (MOULDED COLOURS)

BLACK (A) GREY (L) WHITE (W)

DIFFUSER

CLEAR (X) OPAL (Y)

SAURO 1100

10W CCT SET D15.555.D1KCRB

LAMP INCLUDED: GX53 LED

Technical drawing shows a height of 1100 and a diameter of Ø245.

SAURO 800

10W CCT SET D15.554.D1KCRB

LAMP INCLUDED: GX53 LED

Technical drawing shows a height of 800 and a diameter of Ø245.

SAURO 500

10W CCT SET D15.553.D1KCRB

LAMP INCLUDED: GX53 LED

Technical drawing shows a height of 500 and a diameter of Ø245.

MIRELLA

10W CCT SET D15.505.D1KCRB

LAMP INCLUDED: GX53 LED

Technical drawing shows a height of 520 and a diameter of 240.

GARDEN CLASSIC

- 10 REVIVAL
- 36 GARDEN SMALL
- 52 GARDEN MEDIUM
- 72 GARDEN LARGE
- 88 HALF LANTERN
- 90 BOLLARD
- 96 BOLLARD
- 118 DOWNLIGHT
- 126 UP&DOWN

GARDEN MODERN

- 138 FLOODLIGHT
- 148 IN-GROUND

SOLAR

- 154 BRICKLIGHT
- 164 BULKHEAD
- 183 POST
- 190 SOLAR MODERN
- 198 SOLAR CLASSIC
- 200 LAMPS

ESTER
for details see pag. 99



LIVIA 60
for details see pag.123



MAMETE
for details see pag. 127



LUCIA
for details see pag.179



STEVEN
for details see pag. 103

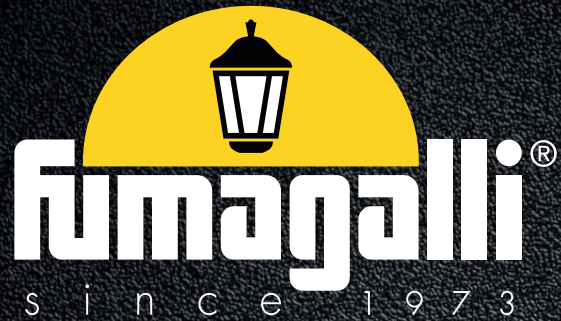

PROMO GARDEN 2024 - MODERN RANGE

CARLO 800
for details see pag.105



ABRAM150
for details see pag.129



MINITOMMY-EL
for details see pag.139



EXTRALETI100 SQUARE
for details see pag. 160



TERESA 90
for details see pag.120



VIRGILIO

BOLLARD



MADE IN ITALY



8,5W	11W
920 lm	1200 lm
2700 K	4000 K
	6500 K

More details at page 195



NEW ENTRY!
available from February 2025



DS3.564.V1K

CCT SETTABLE

SDCM <6

2700 K 4000 K 6500 K



VIRGILIO E27 CCT LED VERSIONS				
LAMP	POWER	LUMINOUS FLUX UP TO	VOLTAGE RANGE	COLOUR TEMPERATURE
	8,5W	920 lm	100-240V 50/60 Hz	6500K/4000K/2700K
	=60W			INCANDESCENT
	11W	1200 lm	100-240V 50/60 Hz	6500K/4000K/2700K
	=75W			INCANDESCENT

AVAILABLE COLORS	
RESIN BODY (MOULDED COLOURS)	DIFFUSER
BLACK (A) GREY (L) WHITE (W)	OPAL (V)

VIRGILIO 800	
	8,5W DS3.564.V1K
	11W DS3.564.T1K



COMING SOON available from February 2025

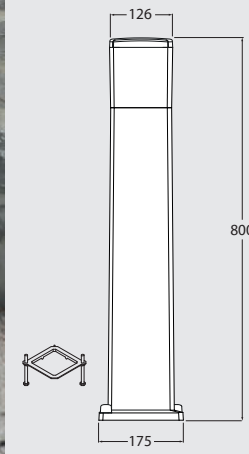

Master box: 6pcs

VIRGILIO 500	
	8,5W DS3.563.V1K
	11W DS3.563.T1K



COMING SOON available from February 2025

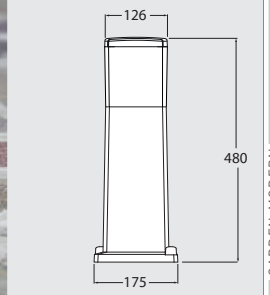

Master box: 12pcs

GARDEN CLASSIC

- 10 REVIVAL
- 36 GARDEN SMALL
- 52 GARDEN MEDIUM
- 72 GARDEN LARGE
- 88 HALF LANTERN
- 90 BOLLARD

GARDEN MODERN

- 96 BOLLARD
- 118 DOWNLIGHT
- 126 UP&DOWN
- 138 FLOODLIGHT
- 148 IN-GROUND
- 154 BRICKLIGHT
- 164 BULKHEAD
- 183 POST

SOLAR

- 190 SOLAR MODERN
- 198 SOLAR CLASSIC
- 200 LAMPS

ESTER

BOLLARD



MADE IN ITALY



DS1.564.D1K

CCT SETTABLE

SDCM <6

3000 K 4000 K 6500 K



BOLLARD

ESTER

ESTER CCT LED VERSIONS					
LAMP	POWER	LUMINOUS FLUX (Φ TOTAL)	VOLTAGE RANGE	CCT SETTABLE	
	3W	410 lm	100-240V 50/60 Hz	6500K/4000K/3000K	=40W INCANDESCENT
	10W	1290 lm	100-240V 50/60 Hz	6500K/4000K/3000K	=100W INCANDESCENT

AVAILABLE COLORS	
RESIN BODY (MOULDED COLOURS)	DIFFUSER
BLACK (A) GREY (L) WHITE (W)	CLEAR (X)

ESTER 800

CCT SET LED GX53 LAMP INCLUDED	3W	DS1.564.G1K
	10W	DS1.564.D1K

Master box: **6pcs**

ESTER 500

CCT SET LED GX53 LAMP INCLUDED	3W	DS1.563.G1K
	10W	DS1.563.D1K

Master box: **12pcs**

ESTER WALL

CCT SET LED GX53 LAMP INCLUDED	3W	DS1.560.G1K
	10W	DS1.560.D1K

Master box: **18pcs**

ESTER SPIKE

CCT SET LED GX53 LAMP INCLUDED	3W	DS1.561.G1K
	10W	DS1.561.D1K

Master box: **18pcs**

- 10 REIVAL
- 36 GARDEN SMALL
- 52 GARDEN MEDIUM
- 72 GARDEN LARGE
- 88 HALF LANTERN
- 90 BOLLARD
- 96 BOLLARD
- 118 DOWNLIGHT
- 126 UP&DOWN
- 138 FLOODLIGHT
- 148 IN-GROUND
- 154 BRICKLIGHT
- 164 BULKHEAD
- 183 POST
- 190 SOLAR MODERN
- 198 SOLAR CLASSIC
- 200 LAMPS

ELISA

BOLLARD



MADE IN ITALY

DS2.564.D1K



CCT SETTABLE

SDCM <6

3000 K 4000 K 6500 K



ELISA CCT LED VERSIONS

LAMP	POWER	LUMINOUS FLUX (Φ TOTAL)	VOLTAGE RANGE	CCT SETTABLE	
GX53	3W	410 lm	100-240V 50/60 Hz	6500K/4000K/3000K	=40W INCANDESCENT
GX53	10W	1290 lm	100-240V 50/60 Hz	6500K/4000K/3000K	=100W INCANDESCENT

AVAILABLE COLORS

RESIN BODY (MOULDED COLOURS)

BLACK (A) GREY (L) WHITE (W)

DIFFUSER

CLEAR (X)

WITH WHITE RESIN REFLECTOR

ELISA 800

CCT SET LED GX53 LAMP INCLUDED	POWER	MODEL
3W	DS2.564.G1K	
10W	DS2.564.D1K	

Master box: **6pcs**

ELISA 500

CCT SET LED GX53 LAMP INCLUDED	POWER	MODEL
3W	DS2.563.G1K	
10W	DS2.563.D1K	

Master box: **12pcs**

ELISA WALL

CCT SET LED GX53 LAMP INCLUDED	POWER	MODEL
3W	DS2.560.G1K	
10W	DS2.560.D1K	

Master box: **18pcs**

ELISA SPIKE

CCT SET LED GX53 LAMP INCLUDED	POWER	MODEL
3W	DS2.561.G1K	
10W	DS2.561.D1K	

Master box: **18pcs**

GARDEN CLASSIC

10 REIVAL

36 GARDEN SMALL

52 GARDEN MEDIUM

72 GARDEN LARGE

88 HALF LANTERN

90 BOLLARD

96 BOLLARD

118 DOWNLIGHT

126 UP&DOWN

GARDEN MODERN

138 FLOODLIGHT

148 IN-GROUND

SOLAR

154 BRICKLIGHT

164 BULKHEAD

183 POST

190 SOLAR MODERN

198 SOLAR CLASSIC

200 LAMPS

STEVEN
BOLLARD



MADE IN ITALY



ST1.531.Z1R



BOLLARD

STEVEN

STEVEN LED VERSIONS				
LAMP	POWER	LUMINOUS FLUX UP TO	VOLTAGE RANGE	COLOUR TEMPERATURE
	1,7W	150 lm	100-240V 50/60 Hz	4000K 3000K

AVAILABLE COLORS							
BODY (MOULDED COLOURS)			DIFFUSER				
BLACK (A)	GREY (L)	WHITE (W)	FROSTED (X)	BLUE (U)	GREEN (N)	ORANGE (R)	

STEVEN

LED LAMP INCLUDED	1,7W	4000K	ST1.531.Z1L
	3000K	ST1.531.Z1R	

SPIKE INSTALLATION

GROUND INSTALLATION

Master box: 10pcs

- 10 REWAL
- 36 GARDEN SMALL
- 52 GARDEN MEDIUM
- 72 GARDEN LARGE
- 88 HALF LANTERN
- 90 BOLLARD
- 96 BOLLARD
- 118 DOWNLIGHT
- 126 UP&DOWN
- 138 FLOODLIGHT
- 148 IN-GROUND
- 154 BRICKLIGHT
- 164 BULKHEAD
- 183 POST
- 190 SOLAR MODERN
- 198 SOLAR CLASSIC
- 200 LAMPS

CARLO / CARLO DECO

BOLLARD



DR1.575.U1K



DR3.570.U1K



DR3.574.U1K

CCT SETTABLE

2700 K 4000 K

SDCM <3



CARLO / CARLO DECO

CARLO CCT LED VERSIONS					
LAMP	POWER	LUMINOUS FLUX (Φ TOTAL) UP TO	VOLTAGE RANGE	CCT SETTABLE	
GU10 LED	3,5W	366 lm	100-240V 50/60 Hz	4000K/2700K	=35W HALOGEN
GU10 LED	6W	615 lm	100-240V 50/60 Hz	4000K/2700K	=50W HALOGEN

AVAILABLE COLORS

RESIN BODY (MOULDED COLOURS)

BLACK (A) GREY (L) WHITE (W)

DIFFUSER

CLEAR (X)

CARLO 800 CARLO 800 DECO

	3,5W	DR1.575.U1K
	6W	DR1.575.L1K
	3,5W	DR3.575.U1K
	6W	DR3.575.L1K

Master box: **6pcs**

CARLO 400 CARLO 400 DECO

	3,5W	DR1.574.U1K
	6W	DR1.574.L1K
	3,5W	DR3.574.U1K
	6W	DR3.574.L1K

Master box: **12pcs**

10	REVIVAL
36	GARDEN SMALL
52	GARDEN MEDIUM
72	GARDEN LARGE
88	HALF LANTERN
90	BOLLARD
96	BOLLARD
118	DOWNLIGHT
126	UP&DOWN
138	FLOODLIGHT
148	IN-GROUND
154	BRICKLIGHT
164	BULKHEAD
183	POST
190	SOLAR MODERN
198	SOLAR CLASSIC
200	LAMPS

CARLO LED VERSIONS					
LAMP	POWER	LUMINOUS FLUX (Φ TOTAL) UP TO	VOLTAGE RANGE	CCT SETTABLE	
	3,5W	366 lm	100-240V 50/60 Hz	4000K/2700K	= 35W HALOGEN
	6W	615 lm	100-240V 50/60 Hz	4000K/2700K	= 50W HALOGEN



CARLO 250

CARLO 250 DECO

3,5W DR1.573.U1K

6W DR1.573.L1K

3,5W DR3.573.U1K

6W DR3.573.L1K

Master box: **20pcs**

3,5W DR1.573.U1K

6W DR1.573.L1K

3,5W DR3.573.U1K

6W DR3.573.L1K

Master box: **20pcs**

CARLO SPIKE

CARLO SPIKE DECO

3,5W DR1.572.U1K

6W DR1.572.L1K

3,5W DR3.572.U1K

6W DR3.572.L1K

Master box: **20pcs**

3,5W DR1.572.U1K

6W DR1.572.L1K

3,5W DR3.572.U1K

6W DR3.572.L1K

Master box: **20pcs**

CARLO CCT LED VERSIONS					
LAMP	POWER	LUMINOUS FLUX (Φ TOTAL) UP TO	VOLTAGE RANGE	CCT SETTABLE	
	3,5W	366 lm	100-240V 50/60 Hz	4000K/2700K	= 35W HALOGEN
	6W	615 lm	100-240V 50/60 Hz	4000K/2700K	= 50W HALOGEN

AVAILABLE COLORS			
RESIN BODY (MOULDED COLOURS)			DIFFUSER

CARLO WALL

CARLO WALL DECO

3,5W DR1.570.U1K

6W DR1.570.L1K

3,5W DR3.570.U1K

6W DR3.570.L1K

Master box: **20pcs**

3,5W DR1.570.U1K

6W DR1.570.L1K

3,5W DR3.570.U1K

6W DR3.570.L1K

Master box: **20pcs**

CARLO-FS

CARLO-FS DECO

3,5W DR1.571.U1K

6W DR1.571.L1K

3,5W DR3.571.U1K

6W DR3.571.L1K

Master box: **20pcs**

3,5W DR1.571.U1K

6W DR1.571.L1K

3,5W DR3.571.U1K

6W DR3.571.L1K

Master box: **20pcs**

GARDEN CLASSIC

10 REVAL

36 GARDEN SMALL

52 GARDEN MEDIUM

72 GARDEN LARGE

88 HALF LANTERN

90 BOLLARD

96 BOLLARD

118 DOWNLIGHT

126 UP&DOWN

GARDEN MODERN

138 FLOODLIGHT

148 IN-GROUND

154 BRICKLIGHT

164 BULKHEAD

183 POST

SOLAR

190 SOLAR MODERN

198 SOLAR CLASSIC

200 LAMPS

AMELIA

BOLLAR



MADE IN ITALY

CCT SET

8,5W 11W
920 lm 1200 lm
2700 K 4000 K 6500 K

More details at page 195



DR2.575.V1K

CCT SETTABLE

SDCM <6

2700 K 4000 K 6500 K



AMELIA CCT LED VERSIONS					
LAMP	POWER	LUMINOUS FLUX UP TO	VOLTAGE RANGE	COLOUR TEMPERATURE	
	8,5W	920 lm	100-240V 50/60 Hz	6500K/4000K/2700K	=60W INCANDESCENT
	11W	1200 lm	100-240V 50/60 Hz	6500K/4000K/2700K	=75W INCANDESCENT

AVAILABLE COLORS

RESIN BODY (MOULDED COLOURS)

BLACK (A) GREY (L) WHITE (W)

DIFFUSER

OPAL (V)

AMELIA 800

CCT SET LED E27 LAMP INCLUDED

8,5W DR2.575.V1K
11W DR2.575.T1K

Master box: **6pcs**

AMELIA 400

CCT SET LED E27 LAMP INCLUDED

8,5W DR2.574.V1K
11W DR2.574.T1K

Master box: **12pcs**

AMELIA 250

CCT SET LED E27 LAMP INCLUDED

8,5W DR2.573.V1K
11W DR2.573.T1K

Master box: **20pcs**

AMELIA SPIKE

CCT SET LED E27 LAMP INCLUDED

8,5W DR2.572.V1K
11W DR2.572.T1K

Master box: **20pcs**

GARDEN CLASSIC

10 REIVAL

36 GARDEN SMALL

52 GARDEN MEDIUM

72 GARDEN LARGE

88 HALF LANTERN

90 BOLLARD

96 BOLLARD

118 DOWNLIGHT

126 UP&DOWN

GARDEN MODERN

138 FLOODLIGHT

148 IN-GROUND

154 BRICKLIGHT

164 BULKHEAD

183 POST

SOLAR

190 SOLAR MODERN

198 SOLAR CLASSIC

200 LAMPS

AMELIA WALL LAMP



DR2.570.V1K

CCT SETTABLE

SDCM <6

2700 K 4000 K 6500 K



AMELIA CCT LED VERSIONS					
LAMP	POWER	LUMINOUS FLUX UP TO	VOLTAGE RANGE	COLOUR TEMPERATURE	
	8,5W	920 lm	100-240V 50/60 Hz	6500K/4000K/2700K	=60W INCANDESCENT
	11W	1200 lm	100-240V 50/60 Hz	6500K/4000K/2700K	=75W INCANDESCENT

AVAILABLE COLORS

RESIN BODY (MOULDED COLOURS)

BLACK (A) GREY (L) WHITE (W)

DIFFUSER

OPAL (V)

AMELIA WALL



CCT SET LED	POWER	MODEL
8,5W	DR2.570.V1K	
11W	DR2.570.T1K	

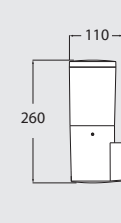

Master box: **20pcs**

AMELIA-FS



CCT SET LED	POWER	MODEL
8,5W	DR2.571.V1K	
11W	DR2.571.T1K	



Master box: **20pcs**

- 10 REVAL
- 36 GARDEN SMALL
- 52 GARDEN MEDIUM
- 72 GARDEN LARGE
- 88 HALF LANTERN
- 90 BOLLARD
- 96 BOLLARD
- 118 DOWNLIGHT
- 126 UP&DOWN
- 138 FLOODLIGHT
- 148 IN-GROUND
- 154 BRICKLIGHT
- 164 BULKHEAD
- 183 POST
- 190 SOLAR MODERN
- 198 SOLAR CLASSIC
- 200 LAMPS

GABRI-MINIGABRI REMI/LUCIA

BOLLARD



MADE IN ITALY



1R3.613.X10.E27

CCT SETTABLE

2700 K 4000 K 6500 K

SDCM <6



LED BULKHEAD GX53				
LAMP	POWER	LUMINOUS FLUX (Φ TOTAL)	VOLTAGE RANGE	CCT SETTABLE
	11,3W	1510 lm	100-240V 50/60 Hz	6500K/4000K/2700K
	17W	2350 lm	100-240V 50/60 Hz	6500K/4000K/2700K

AVAILABLE COLORS		
RESIN BODY (MOULDED COLOURS)		DIFFUSER
BLACK (A)	GREY (L)	WHITE (W)

GABRI REMI/LUCIA 1L

	<p>300 325 1000</p> <p>LUCIA 1R3 LUCIA-EL 2R3 LUCIA-GD 3R3</p>				
		E27	1R3.613.X10.E27	2R3.613.X10.E27	3R3.613.X10.E27
		GX53 LED 11,3W	1R3.613.X10.B1K	2R3.613.X10.B1K	3R3.613.X10.B1K
		GX53 LED 17W	1R3.613.X10.E1K	2R3.613.X10.E1K	3R3.613.X10.E1K

GABRI REMI/LUCIA 2L

	<p>300 410 1000</p> <p>LUCIA 1R3 LUCIA-EL 2R3 LUCIA-GD 3R3</p>				
		E27	1R3.613.X20.E27	2R3.613.X20.E27	3R3.613.X20.E27
		GX53 LED 11,3W	1R3.613.X20.B1K	2R3.613.X20.B1K	3R3.613.X20.B1K
		GX53 LED 17W	1R3.613.X20.E1K	2R3.613.X20.E1K	3R3.613.X20.E1K

MINIGABRI REMI/LUCIA 1L

	<p>300 325 750</p> <p>LUCIA 1R3 LUCIA-EL 2R3 LUCIA-GD 3R3</p>				
		E27	1R3.612.X10.E27	2R3.612.X10.E27	3R3.612.X10.E27
		GX53 LED 11,3W	1R3.612.X10.B1K	2R3.612.X10.B1K	3R3.612.X10.B1K
		GX53 LED 17W	1R3.612.X10.E1K	2R3.612.X10.E1K	3R3.612.X10.E1K

MINIGABRI REMI/LUCIA 2L

	<p>300 410 750</p> <p>LUCIA 1R3 LUCIA-EL 2R3 LUCIA-GD 3R3</p>				
		E27	1R3.612.X20.E27	2R3.612.X20.E27	3R3.612.X20.E27
		GX53 LED 11,3W	1R3.612.X20.B1K	2R3.612.X20.B1K	3R3.612.X20.B1K
		GX53 LED 17W	1R3.612.X20.E1K	2R3.612.X20.E1K	3R3.612.X20.E1K

- 10 RIVAL
- 36 GARDEN SMALL
- 52 GARDEN MEDIUM
- 72 GARDEN LARGE
- 88 HALF LANTERN
- 90 BOLLARD
- 96 BOLLARD
- 118 DOWNLIGHT
- 126 UP&DOWN
- 138 FLOODLIGHT
- 148 IN-GROUND
- 154 BRICKLIGHT
- 164 BULKHEAD
- 183 POST
- 190 SOLAR MODERN
- 198 SOLAR CLASSIC
- 200 LAMPS

GABRI-MINIGABRI REMI/MADDI

BOLLARD



MADE IN ITALY



1V3.613.X20.E27

CCT SETTABLE

2700 K 4000 K 6500 K

SDCM <6



GABRI-MINIGABRI REMI/MADDI

LED BULKHEAD GX53				
LAMP	POWER	LUMINOUS FLUX (Φ TOTAL)	VOLTAGE RANGE	CCT SETTABLE
	11,3W	1510 lm	100-240V 50/60 Hz	6500K/4000K/2700K
	17W	2350 lm	100-240V 50/60 Hz	6500K/4000K/2700K

AVAILABLE COLORS		
RESIN BODY (MOULDED COLOURS)		DIFFUSER
BLACK (A)	GREY (L)	WHITE (W)
		OPAL (O)

GABRI REMI/MADDI 1L

			E27		1V3.613.X10.E27	2V3.613.X10.E27	3V3.613.X10.E27
			GX53 LED 11,3W		1V3.613.X10.B1K	2V3.613.X10.B1K	3V3.613.X10.B1K
			GX53 LED 17W		1V3.613.X10.E1K	2V3.613.X10.E1K	3V3.613.X10.E1K

GABRI REMI/MADDI 2L

			E27		1V3.613.X20.E27	2V3.613.X20.E27	3V3.613.X20.E27
			GX53 LED 11,3W		1V3.613.X20.B1K	2V3.613.X20.B1K	3V3.613.X20.B1K
			GX53 LED 17W		1V3.613.X20.E1K	2V3.613.X20.E1K	3V3.613.X20.E1K

MINIGABRI REMI/MADDI 1L

			E27		1V3.612.X10.E27	2V3.612.X10.E27	3V3.612.X10.E27
			GX53 LED 11,3W		1V3.612.X10.B1K	2V3.612.X10.B1K	3V3.612.X10.B1K
			GX53 LED 17W		1V3.612.X10.E1K	2V3.612.X10.E1K	3V3.612.X10.E1K

MINIGABRI REMI/MADDI 2L

			E27		1V3.612.X20.E27	2V3.612.X20.E27	3V3.612.X20.E27
			GX53 LED 11,3W		1V3.612.X20.B1K	2V3.612.X20.B1K	3V3.612.X20.B1K
			GX53 LED 17W		1V3.612.X20.E1K	2V3.612.X20.E1K	3V3.612.X20.E1K

- 10 REVIVAL
- 36 GARDEN SMALL
- 52 GARDEN MEDIUM
- 72 GARDEN LARGE
- 88 HALF LANTERN
- 90 BOLLARD
- 96 BOLLARD
- 118 DOWNLIGHT
- 126 UP&DOWN
- 138 FLOODLIGHT
- 148 IN-GROUND
- 154 BRICKLIGHT
- 164 BULKHEAD
- 183 POST
- 190 SOLAR MODERN
- 198 SOLAR CLASSIC
- 200 LAMPS

PINELA-MINIPINELA

BOLLARD



MADE IN ITALY



2N1.613.010.P27

CCT SETTABLE

SDCM <6

3000 K 4000 K 6500 K



GERMANA LED VERSIONS					
LAMP	POWER	LUMINOUS FLUX (Φ TOTAL)	VOLTAGE RANGE	CCT SETTABLE	
2x Øx53	2x3W 6W	820 lm	100-240V 50/60 Hz	6500K/4000K/3000K	=75W INCANDESCENT
2x Øx53	2x10W 20W	2570 lm	100-240V 50/60 Hz	6500K/4000K/3000K	=150W INCANDESCENT

AVAILABLE COLORS		
RESIN BODY (MOULDED COLOURS)		DIFFUSER
BLACK (A)	GREY (L)	WHITE (W)
		OPAL (Y)

PINELA 1L

E27		2N1.613.010.P27
2x3W 6W	CCT SET	2N1.613.010.G2K
2x10W 20W	CCT SET	2N1.613.010.D2K

PINELA 2L

E27		2N1.613.020.P27
2x 6W	CCT SET	2N1.613.020.G2K
2x 20W	CCT SET	2N1.613.020.D2K

MINIPINELA 1L

E27		2N1.612.010.P27
2x3W 6W	CCT SET	2N1.612.010.G2K
2x10W 20W	CCT SET	2N1.612.010.D2K

MINIPINELA 2L

E27		2N1.612.020.P27
2x 6W	CCT SET	2N1.612.020.G2K
2x 20W	CCT SET	2N1.612.020.D2K

GARDEN CLASSIC

10 REVAL

36 GARDEN SMALL

52 GARDEN MEDIUM

72 GARDEN LARGE

88 HALF LANTERN

90 BOLLARD

96 BOLLARD

GARDEN MODERN

118 DOWNLIGHT

126 UP&DOWN

138 FLOODLIGHT

148 IN-GROUND

154 BRICKLIGHT

164 BULKHEAD

183 POST

SOLAR

190 SOLAR MODERN

198 SOLAR CLASSIC

200 LAMPS

TERESA RANGE

DOWNLIGHT / DECKLIGHT



MADE IN ITALY



TERESA 50
G9



TERESA 90
GU10



TERESA 160
GX53



TERESA 260
GX53
E27
E27+SENSOR **NEW**



TERESA 50 LED VERSIONS			
LAMP	POWER	LUMINOUS FLUX UP TO	VOLTAGE RANGE
	1,7W	150 lm	100-240V 50/60 Hz
			COLOUR TEMPERATURE
			4000K
			3000K

AVAILABLE COLORS			
COVER (MOULDED COLOURS)			DIFFUSER
BLACK (A)	GREY (L)	WHITE (W)	FROSTED (X) BLUE (U)
			GREEN (N) ORANGE (R)

TERESA 50

4000K	210.000.Z1L
1,7W	3000K 210.000.Z1R

IP67

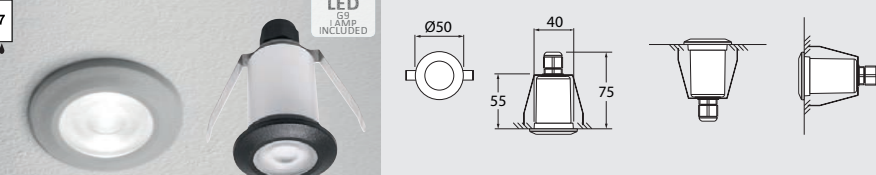

LED LAMP INCLUDED

Master box: **75pcs**

TERESA 50 SQUARE

4000K	214.000.Z1L
1,7W	3000K 214.000.Z1R

IP67

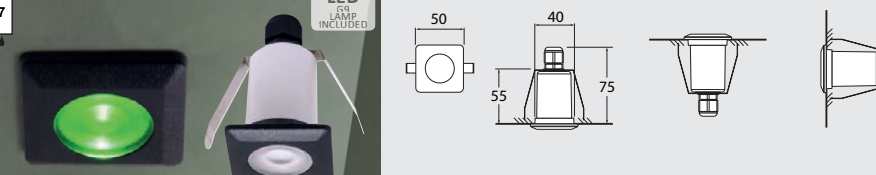

LED LAMP INCLUDED

Master box: **75pcs**

TERESA 50 1L

4000K	211.000.Z1L
1,7W	3000K 211.000.Z1R

IP67

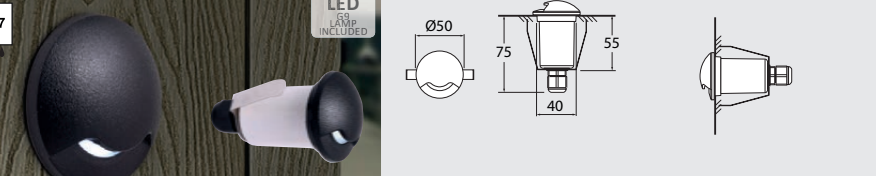

LED LAMP INCLUDED

Master box: **75pcs**

TERESA 50 2L

4000K	212.000.Z1L
1,7W	3000K 212.000.Z1R

IP67

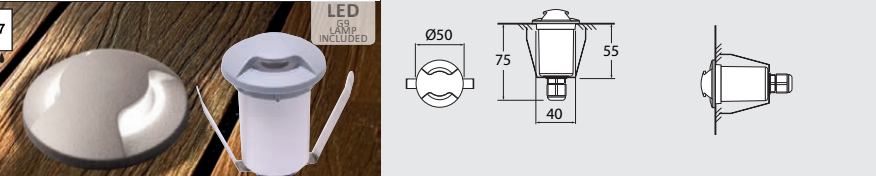

LED LAMP INCLUDED

Master box: **75pcs**

- 10 REVAL
- 36 GARDEN SMALL
- 52 GARDEN MEDIUM
- 72 GARDEN LARGE
- 88 HALF LANTERN
- 90 BOLLARD
- 96 BOLLARD
- 118 DOWNLIGHT
- 126 UP&DOWN
- 138 FLOODLIGHT
- 148 IN-GROUND
- 154 BRICKLIGHT
- 164 BULKHEAD
- 183 POST
- 190 SOLAR MODERN
- 198 SOLAR CLASSIC
- 200 LAMPS

TERESA 90 LED VERSIONS					
LAMP	POWER	LUMINOUS FLUX (Φ TOTAL) LUF TD	VOLTAGE RANGE	CCT SETTABLE	
	3,5W	366 lm	100-240V 50/60 Hz	4000K/2700K	= 35W HALOGEN
	6W	615 lm	100-240V 50/60 Hz	4000K/2700K	= 50W HALOGEN

AVAILABLE COLORS			DIFFUSER
RESIN BODY (MOULDED COLOURS)			

TERESA 90		
GU10 lampholder	3L1.000.GU1	SMART PACK
3,5W	3L0.000.U1K	
6W	3L0.000.L1K	

Standard Master box: **40pcs**
Smart Pack Master box: **100pcs**

TERESA 90 - AVAILABLE VERSIONS

TERESA 90
SINGLE BOX - LAMP INCLUDED

cbm: **0,09**
Master box: **40 pcs**

TERESA 90 GU10
SMART PACK

Save **37%** volume
ECO-friendly packaging
Film wrapped items

cbm: **0,14**
Master box: **5X20= 100 pcs**

TERESA 160 CCT LED VERSIONS				
LAMP	POWER	LUMINOUS FLUX (Φ TOTAL)	VOLTAGE RANGE	CCT SETTABLE
	3W	410 lm	100-240V 50/60 Hz	6500K/4000K/3000K
	10W	1290 lm	100-240V 50/60 Hz	6500K/4000K/3000K

TERESA 260 CCT LED VERSIONS				
LAMP	POWER	LUMINOUS FLUX (Φ TOTAL)	VOLTAGE RANGE	CCT SETTABLE
	11,3W	1510 lm	100-240V 50/60 Hz	6500K/4000K/2700K
	17W	2350 lm	100-240V 50/60 Hz	6500K/4000K/2700K

TERESA 160		
IP55	3W	4L0.000.G1K
CCT SET LED GX53 LAMP INCLUDED	10W	4L0.000.D1K

Master box: **18pcs**

TERESA 260

TERESA 260		
IP55	E27 lampholder	5L0.000.P27
CCT SET LED GX53 LAMP INCLUDED	11,3W	5L0.000.B1K
	17W	5L0.000.E1K

Master box: **16pcs**

SUPPLIED FULLY PRE-WIRED

GX53 LED

E27

E27+SENSOR

WITH SENSOR (S) 220-240V (E27)

- 10 REVAL
- 36 GARDEN SMALL
- 52 GARDEN MEDIUM
- 72 GARDEN LARGE
- 88 HALF LANTERN
- 90 BOLLARD
- 96 BOLLARD
- 118 DOWNLIGHT
- 126 GARDEN MODERN UP&DOWN
- 138 FLOODLIGHT
- 148 IN-GROUND
- 154 BRICKLIGHT
- 164 BULKHEAD
- 183 POST
- 190 SOLAR MODERN
- 198 SOLAR CLASSIC
- 200 LAMPS

LIVIA RANGE

DOWNLIGHT



MADE IN ITALY



1A9.000.Z1L

AVAILABLE COLORS			
RESIN BODY <small>(MOULDED COLOURS)</small>			DIFFUSER
BLACK (A)	GREY (L)	WHITE (W)	FROSTED (X)



LIVIA 60 LED VERSIONS					LIVIA 90 CCT LED VERSIONS					
LAMP	POWER	LUMINOUS FLUX UP TO	VOLTAGE RANGE	COLOUR TEMPERATURE	LAMP	POWER	LUMINOUS FLUX (Ø TOTAL) UP TO	VOLTAGE RANGE	CCT SETTABLE	
	1,7W	150 lm	100-240V 50/60 Hz	4000K		3,5W	366 lm	100-240V 50/60 Hz	4000K/2700K	=35W HALOGEN
				3000K						=50W HALOGEN

LIVIA 60

	1,7W	4000K	1A9.000.Z1L
		3000K	1A9.000.Z1R



Master box: **75pcs**

LIVIA 90

	3,5W	2A9.000.U1K	
		6W	2A9.000.L1K



Master box: **30pcs**

- 10 REVAL
- 36 GARDEN SMALL
- 52 GARDEN MEDIUM
- 72 GARDEN LARGE
- 88 HALF LANTERN
- 90 BOLLARD
- 96 BOLLARD
- 118 DOWNLIGHT
- 126 UP&DOWN
- GARDEN MODERN
- 138 FLOODLIGHT
- 148 IN-GROUND
- 154 BRICKLIGHT
- 164 BULKHEAD
- 183 POST
- SOLAR
- 190 SOLAR MODERN
- 198 SOLAR CLASSIC
- 200 LAMPS

LIVIA RANGE

DOWNLIGHT



MADE IN ITALY



3A9.000.G1K

AVAILABLE COLORS

RESIN BODY <small>(MOULDED COLOURS)</small>			DIFFUSER
BLACK (A)	GREY (L)	WHITE (W)	FROSTED (X)



LIVIA 160 CCT LED VERSIONS						LIVIA 180 CCT LED VERSIONS					
LAMP	POWER	LUMINOUS FLUX (Φ TOTAL)	VOLTAGE RANGE	CCT SETTABLE		LAMP	POWER	LUMINOUS FLUX UP TO	VOLTAGE RANGE	CCT SETTABLE	
	3W	410 lm	100-240V 50/60 Hz	6500K/4000K/3000K	=40W INCANDESCENT		15W	1690 lm	100-240V 50/60 Hz	3000K/ 4000K	=50W HIGI-SON
	10W	1290 lm	100-240V 50/60 Hz	6500K/4000K/3000K	=100W INCANDESCENT		30W	3620 lm	100-240V 50/60 Hz	3000K/ 4000K	=70W HIGI-SON

LIVIA 160

CCT SET LED	POWER	MODEL
	3W	3A9.000.G1K
	10W	3A9.000.D1K

Master box: **18pcs**

LIVIA 180

CCT SET LED	POWER	MODEL
	15W	4A9.000.R1K
	30W	4A9.000.Q1K

Master box: **12pcs**

CCT SETTABLE

SDCM <6

3000 K 4000 K

- 10 REVAL
- 36 GARDEN SMALL
- 52 GARDEN MEDIUM
- 72 GARDEN LARGE
- 88 HALF LANTERN
- 90 BOLLARD
- 96 BOLLARD
- 118 DOWNLIGHT
- 126 UP&DOWN
- 138 FLOODLIGHT
- 148 IN-GROUND
- 154 BRICKLIGHT
- 164 BULKHEAD
- 183 POST
- 190 SOLAR MODERN
- 198 SOLAR CLASSIC
- 200 LAMPS

MAMETE

UP & DOWN



MADE IN ITALY



WALL INSTALLATION

2A3.000.Z1L



1A3.000.Z1L

GROUND INSTALLATION



MAMETE

MAMETE LED VERSIONS			
LAMP	POWER	LUMINOUS FLUX UP TO	VOLTAGE RANGE
	1,7W	150 lm	100-240V 50/60 Hz
			COLOUR TEMPERATURE
			4000K
			3000K

AVAILABLE COLORS						
BODY (MOULDED COLOURS)			DIFFUSER			
BLACK (A)	GREY (U)	WHITE (W)	FROSTED (X)	BLUE (U)	GREEN (N)	ORANGE (R)

MAMETE SQUARE

LED FOR LAMP INCLUDED	4000K	1A3.000.Z1L
	3000K	1A3.000.Z1R

Master box: **50pcs**

MAMETE ROUND

LED FOR LAMP INCLUDED	4000K	2A3.000.Z1L
	3000K	2A3.000.Z1R

Master box: **50pcs**

- 10 REVAL
- 36 GARDEN SMALL
- 52 GARDEN MEDIUM
- 72 GARDEN LARGE
- 88 HALF LANTERN
- 90 BOLLARD
- 96 BOLLARD
- 118 DOWNLIGHT
- 126 UP&DOWN
- 138 FLOODLIGHT
- 148 IN-GROUND
- 154 BRICKLIGHT
- 164 BULKHEAD
- 183 POST
- 190 SOLAR MODERN
- 198 SOLAR CLASSIC
- 200 LAMPS

ABRAM RANGE

UP&DOWN



MADE IN ITALY



AB1.000.J1K

CCT SETTABLE

2700 K 4000 K 6500 K

SDCM <6



ABRAM LED VERSIONS				
LAMP	POWER	LUMINOUS FLUX UP TO	VOLTAGE RANGE	CCT SETTABLE
R7s LED	3,5W	365 lm	100-240V 50/60 Hz	6500K/4000K/2700K
R7s LED	7,5W	790 lm	100-240V 50/60 Hz	6500K/4000K/2700K
R7s LED	10,5W	1160 lm	100-240V 50/60 Hz	6500K/4000K/2700K

RESIN BODY (MOULDED COLOURS)			DIFFUSER
BLACK (A)	GREY (L)	WHITE (W)	CLEAR (X)

ABRAM 150

CCT SET LED R7s LAMP INCLUDED **3,5W** AB1.000.J1K

Technical drawing dimensions: 155 (width), 60 (depth), 120 (height)

Master box: **30pcs**

ABRAM 190

CCT SET LED R7s LAMP INCLUDED **7,5W** AB2.000.K1K

Technical drawing dimensions: 195 (width), 60 (depth), 120 (height)

Master box: **30pcs**

ABRAM 270

CCT SET LED R7s LAMP INCLUDED **10,5W** AB3.000.P1K

Technical drawing dimensions: 265 (width), 60 (depth), 120 (height)

Master box: **14pcs**

- 10 REVAL
- 36 GARDEN SMALL
- 52 GARDEN MEDIUM
- 72 GARDEN LARGE
- 88 HALF LANTERN
- 90 BOLLARD
- 96 BOLLARD
- 118 DOWNLIGHT
- 126 UP&DOWN
- 138 FLOODLIGHT
- 148 IN-GROUND
- 154 BRICKLIGHT
- 164 BULKHEAD
- 183 POST
- 190 SOLAR MODERN
- 198 SOLAR CLASSIC
- 200 LAMPS

FRANCA 90

UP&DOWN



MADE IN ITALY



3A7.002.U1K

CCT SETTABLE

2700 K 4000 K

SDCM <3



UP&DOWN

FRANCA 90

FRANCA 90 CCT LED VERSIONS					
LAMP	POWER	LUMINOUS FLUX (Φ TOTAL) UP TO	VOLTAGE RANGE	CCT SETTABLE	
FRANCA 90 1L GU10 LED	3,5W	366 lm	100-240V 50/60 Hz	4000K/2700K	=35W HALOGEN
FRANCA 90 1L GU10 LED	6W	615 lm	100-240V 50/60 Hz	4000K/2700K	=50W HALOGEN
FRANCA 90 2L 2x GU10 LED	2x 3,5W 7W	732 lm	100-240V 50/60 Hz	4000K/2700K	=2 x 35W HALOGEN
FRANCA 90 2L 2x GU10 LED	2x 6W 12W	1230 lm	100-240V 50/60 Hz	4000K/2700K	=2 x 50W HALOGEN

AVAILABLE COLORS

BODY (MOULDED COLOURS)

BLACK (A) GREY (L) WHITE (W)

DIFFUSER

FROSTED (X) BLUE (U)

GREEN (N) ORANGE (R)

FRANCA 90

CCT SET LED GU10 LAMP INCLUDED	3,5W	3A7.000.U1K
	6W	3A7.000.L1K

Master box: **30pcs**

FRANCA 90 SPIKE

CCT SET LED GU10 LAMP INCLUDED	3,5W	3A7.001.U1K
	6W	3A7.001.L1K

Master box: **30pcs**

FRANCA 90-1L WALL

CCT SET LED GU10 LAMP INCLUDED	3,5W	3A7.002.U1K
	6W	3A7.002.L1K

Master box: **30pcs**

FRANCA 90-2L WALL

CCT SET LED GU10 LAMP INCLUDED	2x3,5W 7W	3A7.003.U2K
	2x6W 12W	3A7.003.L2K

Master box: **20pcs**

- 10 REVAL
- 36 GARDEN SMALL
- 52 GARDEN MEDIUM
- 72 GARDEN LARGE
- 88 HALF LANTERN
- 90 BOLLARD
- 96 BOLLARD
- 118 DOWNLIGHT
- 126 UP&DOWN
- 138 FLOODLIGHT
- 148 IN-GROUND
- 154 BRICKLIGHT
- 164 BULKHEAD
- 183 POST
- 190 SOLAR MODERN
- 198 SOLAR CLASSIC
- 200 LAMPS

MARTA 90

UP&DOWN



MADE IN ITALY



1A4.000.U1K

CCT SETTABLE

2700 K 4000 K

SDCM <3



MARTA 90 CCT LED VERSIONS						
LAMP	POWER	LUMINOUS FLUX (Ø TOTAL UP TO)	VOLTAGE RANGE	CCT SETTABLE		
MARTA 90 1L	GU10 LED 3,5W	366 lm	100-240V 50/60 Hz	4000K/2700K	=35W HALOGEN	
MARTA 90 1L	GU10 LED 6W	615 lm	100-240V 50/60 Hz	4000K/2700K	=50W HALOGEN	
MARTA 90 2L	2x GU10 LED 2x 3,5W 7W	732 lm	100-240V 50/60 Hz	4000K/2700K	=2 x 35W HALOGEN	
MARTA 90 2L	2x GU10 LED 2x 6W 12W	1230 lm	100-240V 50/60 Hz	4000K/2700K	=2 x 50W HALOGEN	

AVAILABLE COLORS

BODY (MOULDED COLOURS)

BLACK (A) GREY (L) WHITE (W)

DIFFUSER

FROSTED (X) BLUE (U)

GREEN (N) ORANGE (R)

MARTA90 1L

CCT SET LED GU10 LAMP INCLUDED	3,5W	1A4.000.U1K
	6W	1A4.000.L1K

Master box: **36pcs**

MARTA90 2L

CCT SET LED GU10 LAMP INCLUDED	2x3,5W 7W	2A4.000.U2K
	2x6W 12W	2A4.000.L2K

Master box: **36pcs**

- 10 REVAL
- 36 GARDEN SMALL
- 52 GARDEN MEDIUM
- 72 GARDEN LARGE
- 88 HALF LANTERN
- 90 BOLLARD
- 96 BOLLARD
- 118 DOWNLIGHT
- 126 UP&DOWN
- 138 FLOODLIGHT
- 148 IN-GROUND
- 154 BRICKLIGHT
- 164 BULKHEAD
- 183 POST
- 190 SOLAR MODERN
- 198 SOLAR CLASSIC
- 200 LAMPS

MARTA 160

UP&DOWN



MADE IN ITALY



1A6.000.G1K

CCT SETTABLE

SDCM <6

3000 K 4000 K 6500 K



MARTA 160 CCT LED VERSIONS				
LAMP	POWER	LUMINOUS FLUX (Φ TOTAL)	VOLTAGE RANGE	CCT SETTABLE
MARTA160 1L 	3W	410 lm	100-240V 50/60 Hz	6500K/4000K/3000K =40W INCANDESCENT
	10W	1290 lm	100-240V 50/60 Hz	6500K/4000K/3000K =100W INCANDESCENT
MARTA160 2L 	2x3W 6W	820 lm	100-240V 50/60 Hz	6500K/4000K/3000K =2x40W INCANDESCENT
	2x10W 20W	2580 lm	100-240V 50/60 Hz	6500K/4000K/3000K =2x100W INCANDESCENT

AVAILABLE COLORS

BODY (MOULDED COLOURS)

BLACK (A) GREY (L) WHITE (W)

DIFFUSER

FROSTED (X) BLUE (U)

GREEN (N) ORANGE (R)

MARTA160 1L



CCT SET
LED
GX53
LAMP
INCLUDED

E27	1A6.000.E27
3W	1A6.000.G1K
10W	1A6.000.D1K

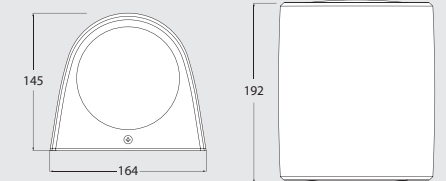

Master box: 18pcs

MARTA160 2L



CCT SET
LED
GX53
LAMP
INCLUDED

2x3W 6W	2A6.000.G2K
2x10W 20W	2A6.000.D2K

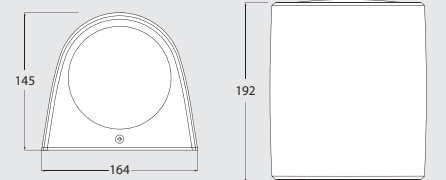

Master box: 18pcs

- 10 REVAL
- 36 GARDEN SMALL
- 52 GARDEN MEDIUM
- 72 GARDEN LARGE
- 88 HALF LANTERN
- 90 BOLLARD
- 96 BOLLARD
- 118 DOWNLIGHT
- 126 UP&DOWN
- 138 FLOODLIGHT
- 148 IN-GROUND
- 154 BRICKLIGHT
- 164 BULKHEAD
- 183 POST
- 190 SOLAR MODERN
- 198 SOLAR CLASSIC
- 200 LAMPS

FRANCY

UP&DOWN



MADE IN ITALY

6,5W 800 lm 2700 K	8,5W 920 lm 2700 K	11W 1200 lm 4000 K	11W 1200 lm 6500 K
--------------------------	--------------------------	--------------------------	--------------------------

More details at page 195



1A1.000.F1R

SMART PACK AVAILABLE

SUPPLIED FULLY PRE-WIRED

2X GX53 LED	FILAMENT LED	CCT LED	E27	E27 + SENSOR
				WITH SENSOR))) 220-240V (E57)



FRANCY LED VERSIONS						AVAILABLE COLORS			
LAMP	POWER	LUMINOUS FLUX UP TO	VOLTAGE RANGE	COLOUR TEMPERATURE		RESIN BODY (MOULDED COLOURS)			DIFFUSER
	6,5W	800 lm	100-240V 50/60 Hz	2700K	=60W INCANDESCENT	BLACK (A)	GREY (L)	WHITE (W)	OPAL (Y)
	8,5W	920 lm	100-240V 50/60 Hz	6500K/4000K/2700K	=60W INCANDESCENT				
2x	2x3W 6W	820 lm (Ø TOTAL)	100-240V 50/60 Hz	6500K/4000K/3000K	=75W INCANDESCENT				

FRANCY

E27	1A2.000.E27	SMART PACK
LED E27 LAMP INCLUDED	6,5W FILAMENT LED 2700K	1A1.000.F1R
	8,5W CCT SET	1A1.000.V1K

Standard Master box: **24pcs**
Smart Pack Master box: **42pcs**

FRANCY-OP

E27	2A2.000.E27	SMART PACK
E27	2A1.000.E27	SINGLE BOX
LED E27 LAMP INCLUDED	6,5W FILAMENT LED 2700K	2A1.000.F1R
	2x3W 6W CCT SET	2A1.000.G2K

Standard Master box: **24pcs**
Smart Pack Master box: **42pcs**

E27 AVAILABLE VERSIONS

FRANCY-OP E27 SINGLE BOX	FRANCY/FRANCY-OP E27 SMART PACK
cbm: 0,14 Master box: 24 pcs	SAVE 40% VOLUME X 42 cbm: 0,15 Master box: 42 pcs
	<ul style="list-style-type: none"> Save 40% volume ECO-friendly packaging Film wrapped items

GARDEN CLASSIC

- 10 REVIVAL
- 36 GARDEN SMALL
- 52 GARDEN MEDIUM
- 72 GARDEN LARGE
- 88 HALF LANTERN
- 90 BOLLARD
- 96 BOLLARD
- 118 DOWNLIGHT
- 126 UP&DOWN

GARDEN MODERN

- 138 FLOODLIGHT
- 148 IN-GROUND
- 154 BRICKLIGHT
- 164 BULKHEAD
- 183 POST

SOLAR

- 190 SOLAR MODERN
- 198 SOLAR CLASSIC
- 200 LAMPS

MINITOMMY FLOODLIGHT



MADE IN ITALY



1M1.001.U1K

CCT SETTABLE

2700 K 4000 K

SDCM <3



MINITOMMY LED VERSIONS					AVAILABLE COLORS				
LAMP	POWER	LUMINOUS FLUX (P TOTAL LUP TO)	VOLTAGE RANGE	CCT SETTABLE	COVER (MOULDED COLOURS)			DIFFUSER	
MINITOMMY FL GU10 LED	3,5W	366 lm	100-240V 50/60 Hz	4000K/2700K HALOGEN	BLACK (A)	GREY (L)	WHITE (W)	FROSTED (X)	BLUE (U)
MINITOMMY FL GU10 LED	6W	615 lm	100-240V 50/60 Hz	4000K/2700K HALOGEN				GREEN (N)	ORANGE (R)
MINITOMMY FL GU10 LED	2x 3,5W	732 lm	100-240V 50/60 Hz	4000K/2700K HALOGEN					
MINITOMMY FL GU10 LED	2x 6W	1230 lm	100-240V 50/60 Hz	4000K/2700K HALOGEN					

MINITOMMY		MINITOMMY SPIKE	
3,5W	1M1.000.U1K	3,5W	1M1.001.U1K
6W	1M1.000.L1K	6W	1M1.001.L1K

Master box: 30pcs

MINITOMMY-EL		MINITOMMY-EL SPIKE	
3,5W	1M2.000.U1K	3,5W	1M2.001.U1K
6W	1M2.000.L1K	6W	1M2.001.L1K

Master box: 30pcs

MINITOMMY 2L		MINITOMMY 2L SPIKE	
2x 3,5W	3M1.000.U2K	2x 3,5W	3M1.001.U2K
2x 6W	3M1.000.L2K	2x 6W	3M1.001.L2K

Master box: 18pcs

MINITOMMY-EL 2L		MINITOMMY-EL 2L SPIKE	
2x 3,5W	3M2.000.U2K	2x 3,5W	3M2.001.U2K
2x 6W	3M2.000.L2K	2x 6W	3M2.001.L2K

Master box: 18pcs

- 10 REVAL
- 36 GARDEN SMALL
- 52 GARDEN MEDIUM
- 72 GARDEN LARGE
- 88 HALF LANTERN
- 90 BOLLARD
- 96 BOLLARD
- 118 DOWNLIGHT
- 126 UP&DOWN
- 138 FLOODLIGHT
- 148 IN-GROUND
- 154 BRICKLIGHT
- 164 BULKHEAD
- 183 POST
- 190 SOLAR MODERN
- 198 SOLAR CLASSIC
- 200 LAMPS

TOMMY FLOODLIGHT



MADE IN ITALY



2M1.000.D1K

CCT SETTABLE

SDCM <6

3000 K 4000 K 6500 K



TOMMY CCT LED VERSIONS						AVAILABLE COLORS				
LAMP	POWER	LUMINOUS FLUX (Φ TOTAL)	VOLTAGE RANGE	CCT SETTABLE		COVER (MOULDED COLOURS)			DIFFUSER	
GX53	3W	410 lm	100-240V 50/60 Hz	6500K/4000K/3000K	=40W INCANDESCENT	BLACK (A)	GREY (L)	WHITE (W)	FROSTED (X)	BLUE (U)
GX53	10W	1290 lm	100-240V 50/60 Hz	6500K/4000K/3000K	=100W INCANDESCENT				GREEN (N)	ORANGE (R)

	TOMMY-SQ	TOMMY-SQ SPIKE
3W	5M1.000.G1K	5M1.001.G1K
10W	5M1.000.D1K	5M1.001.D1K

Master box: **18pcs**

	TOMMY	TOMMY SPIKE
3W	2M1.000.G1K	2M1.001.G1K
10W	2M1.000.D1K	2M1.001.D1K

Master box: **18pcs**

	TOMMY-EL	TOMMY-EL SPIKE
3W	2M2.000.G1K	2M2.001.G1K
10W	2M2.000.D1K	2M2.001.D1K

Master box: **18pcs**

GARDEN CLASSIC

10 REVAL

36 GARDEN SMALL

52 GARDEN MEDIUM

72 GARDEN LARGE

88 HALF LANTERN

90 BOLLARD

96 BOLLARD

118 DOWNLIGHT

126 UP&DOWN

GARDEN MODERN

138 FLOODLIGHT

148 IN-GROUND

154 BRICKLIGHT

164 BULKHEAD

183 POST

SOLAR

190 SOLAR MODERN

198 SOLAR CLASSIC

200 LAMPS

TOMMY 2L FLOODLIGHT



MADE IN ITALY



4M1.001.D2K

CCT SETTABLE

3000 K 4000 K 6500 K

SDCM <6



TOMMY 2L LED VERSIONS						AVAILABLE COLORS				
LAMP	POWER	LUMINOUS FLUX (Φ TOTAL)	VOLTAGE RANGE	CCT SETTABLE		COVER (MOULDED COLOURS)			DIFFUSER	
2x GX53	2x3W 6W	820 lm	100-240V 50/60 Hz	6500K/4000K/3000K	=75W INCANDESCENT	BLACK (A)	GREY (L)	WHITE (W)	FROSTED (X)	BLUE (U)
2x GX53 LED	2x10W 20W	2570 lm	100-240V 50/60 Hz	6500K/4000K/3000K	=150W INCANDESCENT				GREEN (N)	ORANGE (R)

	TOMMY-SQ 2L	TOMMY-SQ 2L SPIKE
FULLY ADJUSTABLE POSITION	2x3W 6W 6M1.000.G2K	2x3W 6W 6M1.001.G2K
	2x10W 20W 6M1.000.D2K	2x10W 20W 6M1.001.D2K
	Master box: 8pcs	Master box: 8pcs

	TOMMY 2L	TOMMY 2L SPIKE
FULLY ADJUSTABLE POSITION	2x3W 6W 4M1.000.G2K	2x3W 6W 4M1.001.G2K
	2x10W 20W 4M1.000.D2K	2x10W 20W 4M1.001.D2K
	Master box: 8pcs	Master box: 8pcs

	TOMMY-EL 2L	TOMMY-EL 2L SPIKE
FULLY ADJUSTABLE POSITION	2x3W 6W 4M2.000.G2K	2x3W 6W 4M2.001.G2K
	2x10W 20W 4M2.000.D2K	2x10W 20W 4M2.001.D2K
	Master box: 8pcs	Master box: 8pcs

- 10 REVAL
- 36 GARDEN SMALL
- 52 GARDEN MEDIUM
- 72 GARDEN LARGE
- 88 HALF LANTERN
- 90 BOLLARD
- 96 BOLLARD
- 118 DOWNLIGHT
- 126 UP&DOWN
- 138 FLOODLIGHT
- 148 IN-GROUND
- 154 BRICKLIGHT
- 164 BULKHEAD
- 183 POST
- 190 SOLAR MODERN
- 198 SOLAR CLASSIC
- 200 LAMPS

GERMANA FLOODLIGHT



MADE IN ITALY



2N1.000.P27

CCT SETTABLE

SDCM <6

3000 K 4000 K 6500 K

SUPPLIED FULLY PRE-WIRED

2x GX53 LED	E27	E27 + SENSOR

WITH SENSOR))
220-240V
(P57)



GERMANA LED VERSIONS				
LAMP	POWER	LUMINOUS FLUX (Φ TOTAL)	VOLTAGE RANGE	CCT SETTABLE
2x GX53	2x3W 6W	820 lm	100-240V 50/60 Hz	6500K/4000K/3000K =75W INCANDESCENT
2x GX53 LED	2x10W 20W	2570 lm	100-240V 50/60 Hz	6500K/4000K/3000K =150W INCANDESCENT

AVAILABLE COLORS			
RESIN BODY (MOULDED COLOURS)			DIFFUSER
BLACK (A)	GREY (L)	WHITE (W)	OPAL (Y)

GERMANA



CCT SET
LED
GX53
LAMP
INCLUDED

E27	2N1.000.P27
2x3W 6W	2N1.000.G2K
2x10W 20W	2N1.000.D2K

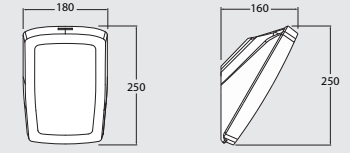

Master box: 18pcs

GIOVA/GERMANA



CCT SET
LED
GX53
LAMP
INCLUDED

E27	2N1.702.P27
2x3W 6W	2N1.702.G2K
2x10W 20W	2N1.702.D2K

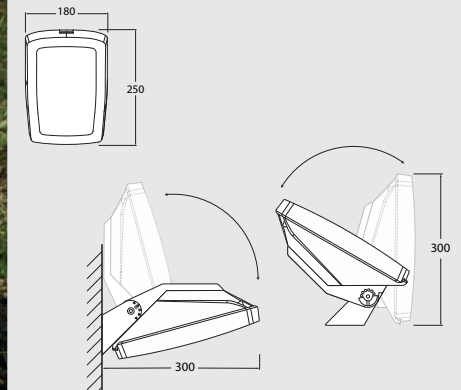

Master box: 18pcs

GARDEN CLASSIC

- 10 REVAL
- 36 GARDEN SMALL
- 52 GARDEN MEDIUM
- 72 GARDEN LARGE
- 88 HALF LANTERN
- 90 BOLLARD
- 96 BOLLARD
- 118 DOWNLIGHT
- 126 UP&DOWN

GARDEN MODERN

- 138 FLOODLIGHT
- 148 IN-GROUND
- 154 BRICKLIGHT
- 164 BULKHEAD
- 183 POST

SOLAR

- 190 SOLAR MODERN
- 198 SOLAR CLASSIC
- 200 LAMPS

GIUSEPPE FLOODLIGHT



MADE IN ITALY



4P2.000.E28

SUPPLIED FULLY PRE-WIRED

GX53 LED	GX53 LED + SENSOR	4x GX53 LED	2x E27	2x E27 + SENSOR
	WITH SENSOR))) (220-240V)			WITH SENSOR))) (220-240V (.ES8))
	11,3W CCT (.85K) 17W CCT (.ESK)			



GIUSEPPE LED VERSIONS

LAMP	POWER	LUMINOUS FLUX (Φ TOTAL)	VOLTAGE RANGE	CCT SETTABLE	
	11,3W	1510 lm	100-240V 50/60 Hz	6500K/4000K/2700K	=100W INCANDESCENT
	17W	2350 lm	100-240V 50/60 Hz	6500K/4000K/2700K	=150W INCANDESCENT
4x GX53	4x10W 40W	5160 lm	100-240V 50/60 Hz	6500K/4000K/3000K	=100W HQI-SON

AVAILABLE COLORS

RESIN BODY (MOULDED COLOURS)			DIFFUSER
BLACK (A)	GREY (L)	WHITE (W)	OPAL (Y)

GIUSEPPE

2x E27	4P2.000.E28
11,3W	4P1.000.B1K
17W	4P1.000.E1K
4x10W 40W	4P2.000.D4K

CCT SET
LED
GX53
LAMP
INCLUDED

Master box: **10pcs**

GIOVA/GIUSEPPE

2x E27	4P2.702.E28
11,3W	4P1.702.B1K
17W	4P1.702.E1K
4x10W 40W	4P2.702.D4K

CCT SET
LED
GX53
LAMP
INCLUDED

Master box: **10pcs**

GARDEN CLASSIC

- 10 REVAL
- 36 GARDEN SMALL
- 52 GARDEN MEDIUM
- 72 GARDEN LARGE
- 88 HALF LANTERN
- 90 BOLLARD
- 96 BOLLARD
- 118 DOWNLIGHT
- 126 UP&DOWN

GARDEN MODERN

- 138 FLOODLIGHT
- 148 IN-GROUND
- 154 BRICKLIGHT
- 164 BULKHEAD
- 183 POST

SOLAR

- 190 SOLAR MODERN
- 198 SOLAR CLASSIC
- 200 LAMPS

ALDO
IN-GROUND / RECESSED



MADE IN ITALY



1L1.000.Z1L

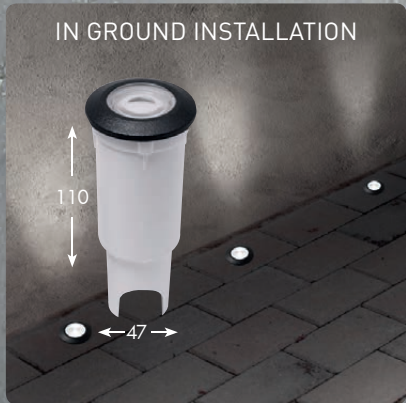

ALDO LED VERSIONS					AVAILABLE COLORS				
LAMP	POWER	LUMINOUS FLUX UP TO	VOLTAGE RANGE	COLOUR TEMPERATURE	COVER (MOULDED COLOURS)			DIFFUSER	
	1,7W	150 lm	100-240V 50/60 Hz	4000K 3000K	BLACK (A)	GREY (L)	WHITE (W)	FROSTED (X)	BLUE (U)
								GREEN (N)	ORANGE (R)

ALDO

IN GROUND	<p>Ø50 110 47</p>	<p>1,7W</p> <p>4000K 110.000.Z1L 3000K 110.000.Z1R</p> <p>LED G9 LAMP INCLUDED</p> <p>Master box: 75pcs</p>	<p>Ø50 70</p>	RECESSED
-----------	---------------------------	---	-------------------	----------

ALDO 1L

IN GROUND	<p>Ø50 110 47</p>	<p>1,7W</p> <p>4000K 111.000.Z1L 3000K 111.000.Z1R</p> <p>LED G9 LAMP INCLUDED</p> <p>Master box: 75pcs</p>	<p>Ø50 70</p>	RECESSED
-----------	---------------------------	---	-------------------	----------

ALDO 2L

IN GROUND	<p>Ø50 110 47</p>	<p>1,7W</p> <p>4000K 112.000.Z1L 3000K 112.000.Z1R</p> <p>LED G9 LAMP INCLUDED</p> <p>Master box: 75pcs</p>	<p>Ø50 70</p>	RECESSED
-----------	---------------------------	---	-------------------	----------

ALDO SQUARE

IN GROUND	<p>Ø50 110 47</p>	<p>1,7W</p> <p>4000K 114.000.Z1L 3000K 114.000.Z1R</p> <p>LED G9 LAMP INCLUDED</p> <p>Master box: 75pcs</p>	<p>Ø50 70</p>	RECESSED
-----------	---------------------------	---	-------------------	----------

- 10 REVAL
- 36 GARDEN SMALL
- 52 GARDEN MEDIUM
- 72 GARDEN LARGE
- 88 HALF LANTERN
- 90 BOLLARD
- 96 BOLLARD
- 118 DOWNLIGHT
- 126 UP&DOWN
- 138 FLOODLIGHT
- 148 IN-GROUND
- 154 BRICKLIGHT
- 164 BULKHEAD
- 183 POST
- 190 SOLAR MODERN
- 198 SOLAR CLASSIC
- 200 LAMPS

CECI
IN-GROUND



MADE IN ITALY



1F2.000.U1K

CCT SETTABLE

2700 K 4000 K

SDCM <3



CECI 90 CCT LED VERSIONS

LAMP	POWER	LUMINOUS FLUX (Φ TOTAL) UP TO	VOLTAGE RANGE	CCT SETTABLE	
GU10 LED	3,5W	366 lm	100-240V 50/60 Hz	4000K/2700K	=35W HALOGEN
GU10 LED	6W	615 lm	100-240V 50/60 Hz	4000K/2700K	=50W HALOGEN

AVAILABLE COLORS

BODY (MOULDED COLOURS)		DIFFUSER	
BLACK (A)	GREY (L)	FROSTED (X)	BLUE (U)
		GREEN (N)	ORANGE (R)

CECI 90

CCT SET LED GU10 LAMP INCLUDED	POWER	SKU
	3,5W	1F1.000.U1K
	6W	1F1.000.L1K

Master box: **40pcs**

CECI 90-2L

CCT SET LED GU10 LAMP INCLUDED	POWER	SKU
	3,5W	1F2.000.U1K
	6W	1F2.000.L1K

Master box: **40pcs**

CECI 90-3L

CCT SET LED GU10 LAMP INCLUDED	POWER	SKU
	3,5W	1F3.000.U1K
	6W	1F3.000.L1K

Master box: **40pcs**

CECI 90-SQ

CCT SET LED GU10 LAMP INCLUDED	POWER	SKU
	3,5W	1F4.000.U1K
	6W	1F4.000.L1K

Master box: **40pcs**

- 10 REVIVAL
- 36 GARDEN SMALL
- 52 GARDEN MEDIUM
- 72 GARDEN LARGE
- 88 HALF LANTERN
- 90 BOLLARD
- 96 BOLLARD
- 118 DOWNLIGHT
- 126 UP&DOWN
- 138 FLOODLIGHT
- 148 IN-GROUND
- 154 BRICKLIGHT
- 164 BULKHEAD
- 183 POST
- 190 SOLAR MODERN
- 198 SOLAR CLASSIC
- 200 LAMPS

AVAILABLE COLORS

COVER (MOULDED COLOURS)

BLACK (A) GREY (L)

DIFFUSER

PROSTED (X)

BLUE (U) GREEN (N) ORANGE (R)

CE, IP67, UV, DOUBLE INSULATION CLASS, ANTI-SHOOT, RECYCLABLE

CECI 120 LED VERSIONS					
LAMP	POWER	LUMINOUS FLUX (Ø TOTAL)	VOLTAGE RANGE	CCT SETTABLE	
	3W	410 lm	100-240V 50/60 Hz	6500K/4000K/3000K	= 40W INCANDESCENT

CECI 120

LED GX53 LAMP INCLUDED

3W 2F1.000.G1K

Master box: **36pcs**

CECI 120-2L

LED GX53 LAMP INCLUDED

3W 2F2.000.G1K

Master box: **36pcs**

CECI 120-3L

LED GX53 LAMP INCLUDED

3W 2F3.000.G1K

Master box: **36pcs**

CECI 120-SQ

LED GX53 LAMP INCLUDED

3W 2F4.000.G1K

Master box: **36pcs**

TUV SUD, IECCE CIP SCHEME

CECI 160 LED VERSIONS					
LAMP	POWER	LUMINOUS FLUX (Ø TOTAL)	VOLTAGE RANGE	CCT SETTABLE	
	10W	1290 lm	100-240V 50/60 Hz	6500K/4000K/3000K	= 100W INCANDESCENT

CECI 160

LED GX53 LAMP INCLUDED

10W 3F1.000.D1K

Master box: **18pcs**

CECI 160-2L

LED GX53 LAMP INCLUDED

10W 3F2.000.D1K

Master box: **18pcs**

CECI 160-3L

LED GX53 LAMP INCLUDED

10W 3F3.000.D1K

Master box: **18pcs**

CECI 160-SQ

LED GX53 LAMP INCLUDED

10W 3F4.000.D1K

Master box: **18pcs**

- 10 REVAL
- 36 GARDEN SMALL
- 52 GARDEN MEDIUM
- 72 GARDEN LARGE
- 88 HALF LANTERN
- 90 BOLLARD
- 96 BOLLARD
- 118 DOWNLIGHT
- 126 UP&DOWN
- 138 FLOODLIGHT
- 148 IN-GROUND
- 154 BRICKLIGHT
- 164 BULKHEAD
- 183 POST
- 190 SOLAR MODERN
- 198 SOLAR CLASSIC
- 200 LAMPS

NINA RANGE

BRICKLIGHT



MADE IN ITALY

6C1.000.J1K

CCT SETTABLE

2700 K 4000 K 6500 K

SDCM <6



NINA LED VERSIONS			
LAMP	POWER	LUMINOUS FLUX UP TO	VOLTAGE RANGE
R7s LED	3,5W	365 lm	100-240V 50/60 Hz
R7s LED	7,5W	790 lm	100-240V 50/60 Hz
R7s LED	10,5W	1160 lm	100-240V 50/60 Hz

AVAILABLE COLORS			
RESIN BODY (MOULDED COLOURS)			DIFFUSER
BLACK (A)	GREY (L)	WHITE (W)	OPAL (Y)

NINA 150

CCT SET LED R7s LAMP INCLUDED **3,5W** 6C1.000.J1K

Master box: **50pcs**

NINA 190

CCT SET LED R7s LAMP INCLUDED **7,5W** 7C1.000.K1K

Master box: **50pcs**

NINA 270

CCT SET LED R7s LAMP INCLUDED **10,5W** 8C1.000.P1K

Master box: **30pcs**

- 10 REVAL
- 36 GARDEN SMALL
- 52 GARDEN MEDIUM
- 72 GARDEN LARGE
- 88 HALF LANTERN
- 90 BOLLARD
- 96 BOLLARD
- 118 DOWNLIGHT
- 126 UP&DOWN
- 138 FLOODLIGHT
- 148 IN-GROUND
- 154 BRICKLIGHT
- 164 BULKHEAD
- 183 POST
- 190 SOLAR MODERN
- 198 SOLAR CLASSIC
- 200 LAMPS

LORENZA RANGE

BRICKLIGHT



MADE IN ITALY



AS1.000.J1K

CCT SETTABLE

2700 K 4000 K 6500 K

SDCM <6



LORENZA LED VERSIONS			
LAMP	POWER	LUMINOUS FLUX UP TO	VOLTAGE RANGE
R7s LED	3,5W	365 lm	100-240V 50/60 Hz
R7s LED	7,5W	790 lm	100-240V 50/60 Hz
R7s LED	10,5W	1160 lm	100-240V 50/60 Hz

AVAILABLE COLORS

RESIN BODY (MOULDED COLOURS)

BLACK (A) GREY (L) WHITE (W)

DIFFUSER

CLEAR (X)

LORENZA 150

CCT SET LED R7s LAMP INCLUDED **3,5W** AS1.000.J1K

Master box: **24pcs**

LORENZA 190

CCT SET LED R7s LAMP INCLUDED **7,5W** AS2.000.K1K

Master box: **24pcs**

LORENZA 270

CCT SET LED R7s LAMP INCLUDED **10,5W** AS3.000.P1K

Master box: **14pcs**

- 10 REVAL
- 36 GARDEN SMALL
- 52 GARDEN MEDIUM
- 72 GARDEN LARGE
- 88 HALF LANTERN
- 90 BOLLARD
- 96 BOLLARD
- 118 DOWNLIGHT
- 126 UP&DOWN
- 138 FLOODLIGHT
- 148 IN-GROUND
- 154 BRICKLIGHT
- 164 BULKHEAD
- 183 POST
- 190 SOLAR MODERN
- 198 SOLAR CLASSIC
- 200 LAMPS

LETI RANGE BRICKLIGHT



MADE IN ITALY

2C1.000.G1K



CCT SETTABLE

SDCM <6

3000 K 4000 K 6500 K



LETI/EXTRALETI 100 CCT LED VERSIONS					
LAMP	POWER	LUMINOUS FLUX (Φ TOTAL)	VOLTAGE RANGE	CCT SETTABLE	
GX53	3W	410 lm	100-240V 50/60 Hz	6500K/4000K/3000K	≈40W INCANDESCENT

AVAILABLE COLORS			
COVER (MOULDED COLOURS)		DIFFUSER	
BLACK (A)	GREY (L)	WHITE (W)	OPAL (Y)

LETI 100 ROUND

CCT SET LED GX53 LAMP INCLUDED 3W 2C1.000.G1K

Master box: 48pcs

EXTRALETI 100 ROUND

CCT SET LED GX53 LAMP INCLUDED 3W 2S1.000.G1K

Master box: 48pcs

LETI 100 ROUND-GR

CCT SET LED GX53 LAMP INCLUDED 3W 2C2.000.G1K

Master box: 48pcs

EXTRALETI 100 ROUND-GR

CCT SET LED GX53 LAMP INCLUDED 3W 2S2.000.G1K

Master box: 48pcs

LETI 100 ROUND-EL

CCT SET LED GX53 LAMP INCLUDED 3W 2C3.000.G1K

Master box: 48pcs

EXTRALETI 100 ROUND-EL

CCT SET LED GX53 LAMP INCLUDED 3W 2S3.000.G1K

Master box: 48pcs

LETI 100 ROUND-ST

CCT SET LED GX53 LAMP INCLUDED 3W 2C4.000.G1K

Master box: 48pcs

EXTRALETI 100 ROUND-ST

CCT SET LED GX53 LAMP INCLUDED 3W 2S4.000.G1K

Master box: 48pcs

- 10 REIVAL
- 36 GARDEN SMALL
- 52 GARDEN MEDIUM
- 72 GARDEN LARGE
- 88 HALF LANTERN
- 90 BOLLARD
- 96 BOLLARD
- 118 DOWNLIGHT
- 126 UP&DOWN
- 138 FLOODLIGHT
- 148 IN-GROUND
- 154 BRICKLIGHT
- 164 BULKHEAD
- 183 POST
- 190 SOLAR MODERN
- 198 SOLAR CLASSIC
- 200 LAMPS

LETI/EXTRALETI 100 LED VERSIONS					
LAMP	POWER	LUMINOUS FLUX (Φ TOTAL)	VOLTAGE RANGE	CCT SETTABLE	
	3W	410 lm	100-240V 50/60 Hz	6500K/4000K/3000K	=40W INCANDESCENT

AVAILABLE COLORS			
COVER	DIFFUSER		
(MOULDED COLOURS)			
BLACK (A)	GREY (L)	WHITE (W)	OPAL (Y)

LETI 100 SQUARE

CCT SET LED GX53 LAMP INCLUDED 3W 3C1.000.G1K

Master box: 48pcs

EXTRALETI 100 SQUARE

CCT SET LED GX53 LAMP INCLUDED 3W 3S1.000.G1K

Master box: 48pcs

LETI 100 SQUARE-GR

CCT SET LED GX53 LAMP INCLUDED 3W 3C2.000.G1K

Master box: 48pcs

EXTRALETI 100 SQUARE-GR

CCT SET LED GX53 LAMP INCLUDED 3W 3S2.000.G1K

Master box: 48pcs

LETI 100 SQUARE-EL

CCT SET LED GX53 LAMP INCLUDED 3W 3C3.000.G1K

Master box: 48pcs

EXTRALETI 100 SQUARE-EL

CCT SET LED GX53 LAMP INCLUDED 3W 3S3.000.G1K

Master box: 48pcs

LETI 100 SQUARE-ST

CCT SET LED GX53 LAMP INCLUDED 3W 3C4.000.G1K

Master box: 48pcs

EXTRALETI 100 SQUARE-ST

CCT SET LED GX53 LAMP INCLUDED 3W 3S4.000.G1K

Master box: 48pcs

LETI/EXTRALETI 200 CCT LED VERSIONS					
LAMP	POWER	LUMINOUS FLUX (Φ TOTAL)	VOLTAGE RANGE	CCT SETTABLE	
	3W	410 lm	100-240V 50/60 Hz	6500K/4000K/3000K	=40W INCANDESCENT

AVAILABLE COLORS			
COVER	DIFFUSER		
(MOULDED COLOURS)			
BLACK (A)	GREY (L)	WHITE (W)	OPAL (Y)

LETI 200

CCT SET LED GX53 LAMP INCLUDED 3W 4C1.000.G1K

Master box: 36pcs

EXTRALETI 200

CCT SET LED GX53 LAMP INCLUDED 3W 4S1.000.G1K

Master box: 36pcs

LETI 200-GL

CCT SET LED GX53 LAMP INCLUDED 3W 4C2.000.G1K

Master box: 36pcs

EXTRALETI 200-GL

CCT SET LED GX53 LAMP INCLUDED 3W 4S2.000.G1K

Master box: 36pcs

LETI 200-RS

CCT SET LED GX53 LAMP INCLUDED 3W 4C3.000.G1K

Master box: 36pcs

EXTRALETI 200-RS

CCT SET LED GX53 LAMP INCLUDED 3W 4S3.000.G1K

Master box: 36pcs

LETI 200-HS

CCT SET LED GX53 LAMP INCLUDED 3W 4C4.000.G1K

Master box: 36pcs

EXTRALETI 200-HS

CCT SET LED GX53 LAMP INCLUDED 3W 4S4.000.G1K

Master box: 36pcs

LETI 200-VP

CCT SET LED GX53 LAMP INCLUDED 3W 4C5.000.G1K

Master box: 36pcs

EXTRALETI 200-VP

CCT SET LED GX53 LAMP INCLUDED 3W 4S5.000.G1K

Master box: 36pcs

- 10 REVAL
- 36 GARDEN SMALL
- 52 GARDEN MEDIUM
- 72 GARDEN LARGE
- 88 HALF LANTERN
- 90 BOLLARD
- 96 BOLLARD
- 118 DOWNLIGHT
- 126 UP&DOWN
- 138 FLOODLIGHT
- 148 IN-GROUND
- 154 BRICKLIGHT
- 164 BULKHEAD
- 183 POST
- 190 SOLAR MODERN
- 198 SOLAR CLASSIC
- 200 LAMPS

LETI 300/EXTRALETI 300

BRICKLIGHT



MADE IN ITALY



5S1.000.G2K

NEW SLIMMER BODY VERSION

CCT SETTABLE

3000 K 4000 K 6500 K

SDCM <6

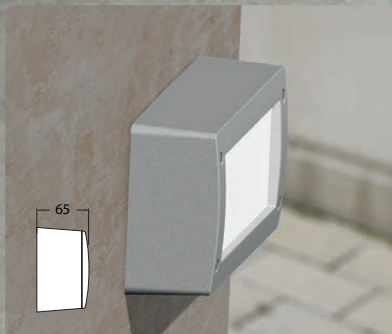

LETI/EXTRALETI 300 LED VERSIONS					
LAMP	POWER	LUMINOUS FLUX (Φ TOTAL)	VOLTAGE RANGE	CCT SETTABLE	
2x GX53	2x 3W 6W	820 lm	100-240V 50/60 Hz	6500K/4000K/3000K	=75W INCANDESCENT

AVAILABLE COLORS			
COVER (MOULDED COLOURS)		DIFFUSER	
BLACK (A)	GREY (L)	WHITE (W)	OPAL (Y)

LETI 300

CCT SET LED GX53 LAMP INCLUDED 2x3W 6W 5C1.000.G2K

E27 5C1.000.E27

Master box: **24pcs**

EXTRALETI 300

CCT SET LED GX53 LAMP INCLUDED 2x3W 6W 5S1.000.G2K

Master box: **20pcs**

LETI 300-GL

CCT SET LED GX53 LAMP INCLUDED 2x3W 6W 5C2.000.G2K

E27 5C2.000.E27

Master box: **24pcs**

EXTRALETI 300-GL

CCT SET LED GX53 LAMP INCLUDED 2x3W 6W 5S2.000.G2K

Master box: **20pcs**

LETI 300-RS

CCT SET LED GX53 LAMP INCLUDED 2x3W 6W 5C3.000.G2K

E27 5C3.000.E27

Master box: **24pcs**

EXTRALETI 300-RS

CCT SET LED GX53 LAMP INCLUDED 2x3W 6W 5S3.000.G2K

Master box: **20pcs**

LETI 300-HS

CCT SET LED GX53 LAMP INCLUDED 2x3W 6W 5C4.000.G2K

E27 5C4.000.E27

Master box: **24pcs**

EXTRALETI 300-HS

CCT SET LED GX53 LAMP INCLUDED 2x3W 6W 5S4.000.G2K

Master box: **20pcs**

LETI 300-VP

CCT SET LED GX53 LAMP INCLUDED 2x3W 6W 5C5.000.G2K

E27 5C5.000.E27

Master box: **24pcs**

EXTRALETI 300-VP

CCT SET LED GX53 LAMP INCLUDED 2x3W 6W 5S5.000.G2K

Master box: **20pcs**

GARDEN CLASSIC

10 REIVAL

36 GARDEN SMALL

52 GARDEN MEDIUM

72 GARDEN LARGE

88 HALF LANTERN

90 BOLLARD

GARDEN MODERN

96 BOLLARD

118 DOWNLIGHT

126 UP&DOWN

138 FLOODLIGHT

148 IN-GROUND

154 BRICKLIGHT

164 BULKHEAD

183 POST

SOLAR

190 SOLAR MODERN

198 SOLAR CLASSIC

200 LAMPS

BERTINA BULKHEAD

Ø200 Ø275 Ø350
 BERTINA BERTA UMBERTA

 since 1973











MADE IN ITALY



1B1.000





**NO SCREWS
AT SIGHT**

CCT SETTABLE

SDCM <6

BERTINA CCT LED VERSIONS

LAMP	POWER	LUMINOUS FLUX (Φ TOTAL)	VOLTAGE RANGE	CCT SETTABLE	
	3W	410 lm	100-240V 50/60 Hz	6500K/4000K/3000K	=40W INCANDESCENT 
	10W	1290 lm	100-240V 50/60 Hz	6500K/4000K/3000K	=100W INCANDESCENT 

AVAILABLE COLORS

RESIN BODY (MOULDED COLOURS)

BLACK (A) 
 GREY (L) 
 WHITE (W) 

DIFFUSER

OPAL (Y) 

BERTINA

3W	1B1.000.G1K
10W	1B1.000.D1K

CCT SET LED GX53 LAMP INCLUDED



Master box: **45pcs**

AVAILABLE VERSIONS SUPPLIED FULLY PRE-WIRED

GX53 LED-CCT SETTABLE



CCT SET 

 **3W**
 **10W**

- 10 REVAL
- 36 GARDEN SMALL
- 52 GARDEN MEDIUM
- 72 GARDEN LARGE
- 88 HALF LANTERN
- 90 BOLLARD
- 96 BOLLARD
- 118 DOWNLIGHT
- 126 UP&DOWN
- 138 FLOODLIGHT
- 148 IN-GROUND
- 154 BRICKLIGHT
- 164 BULKHEAD
- 183 POST
- 190 SOLAR MODERN
- 198 SOLAR CLASSIC
- 200 LAMPS

BERTA

BULKHEAD



NO SCREWS AT SIGHT

1B2.000



CCT SETTABLE

2700 K 4000 K 6500 K

SDCM <6

SMART PACK AVAILABLE

SUPPLIED FULLY PRE-WIRED



BERTA CCT LED VERSIONS					
LAMP	POWER	LUMINOUS FLUX (Φ TOTAL)	VOLTAGE RANGE	CCT SETTABLE	
	11,3W	1510 lm	100-240V 50/60 Hz	6500K/4000K/2700K	=100W INCANDESCENT
	17W	2350 lm	100-240V 50/60 Hz	6500K/4000K/2700K	=150W INCANDESCENT

AVAILABLE COLORS			
RESIN BODY (MOULDED COLOURS)			DIFFUSER
BLACK (A)	GREY (L)	WHITE (W)	OPAL (Y)

BERTA			
E27	2B2.000.P27	SMART PACK	
E27	1B2.000.P27	SINGLE BOX	
11,3W LED	1B2.000.B1K		
17W LED	1B2.000.E1K		

CCT SET LED GX53 LAMP INCLUDED

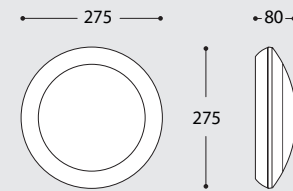

Master box: 16pcs

BERTA - AVAILABLE VERSIONS

BERTA E27 SINGLE BOX	BERTA E27 SMART PACK
cbm: 0,19 Master box: 16 pcs	<p>SAVE 21% VOLUME</p> <ul style="list-style-type: none"> Save 21% volume ECO-friendly packaging Film wrapped items
	cbm: 0,15 Master box: 16 pcs

- 10 REIVAL
- 36 GARDEN SMALL
- 52 GARDEN MEDIUM
- 72 GARDEN LARGE
- 88 HALF LANTERN
- 90 BOLLARD
- 96 BOLLARD
- 118 DOWNLIGHT
- 126 UP&DOWN
- 138 FLOODLIGHT
- 148 IN-GROUND
- 154 BRICKLIGHT
- 164 BULKHEAD
- 183 POST
- 190 SOLAR MODERN
- 198 SOLAR CLASSIC
- 200 LAMPS

UMBERTA

BULKHEAD



MADE IN ITALY



1B3.000

NO SCREWS AT SIGHT

CCT SETTABLE

2700 K 4000 K 6500 K

SDCM <6

SMART PACK AVAILABLE



UMBERTA CCT LED VERSIONS				
LAMP	POWER	LUMINOUS FLUX (Φ TOTAL)	VOLTAGE RANGE	CCT SETTABLE
	11,3W	1510 lm	100-240V 50/60 Hz	6500K/4000K/2700K =100W INCANDESCENT
	17W	2350 lm	100-240V 50/60 Hz	6500K/4000K/2700K =150W INCANDESCENT

AVAILABLE COLORS			
RESIN BODY (MOULDED COLOURS)			DIFFUSER
BLACK (A)	GREY (L)	WHITE (W)	OPAL (Y)

UMBERTA

E27	2B3.000.E27	SMART PACK
2x E27	2B3.000.E28	SMART PACK
E27	1B3.000.E27	SINGLE BOX
2x E27	1B3.000.E28	SINGLE BOX
11,3W LED	1B3.000.B1K	
17W LED	1B3.000.E1K	

CCT SET LED GX53 LAMP INCLUDED

Standard Master box: **12pcs**
Smart Pack Master box: **16pcs**

UMBERTA - AVAILABLE VERSIONS

UMBERTA E27 SINGLE BOX	UMBERTA E27 SMART PACK
cbm: 0,19 Master box: 12 pcs	<p>SAVE 20% VOLUME</p> <ul style="list-style-type: none"> Save 20% volume ECO-friendly packaging Film wrapped items
	cbm: 0,21 Master box: 16 pcs

- 10 REVAL
- 36 GARDEN SMALL
- 52 GARDEN MEDIUM
- 72 GARDEN LARGE
- 88 HALF LANTERN
- 90 BOLLARD
- 96 BOLLARD
- 118 DOWNLIGHT
- 126 UP&DOWN
- 138 FLOODLIGHT
- 148 IN-GROUND
- 154 BRICKLIGHT
- 164 BULKHEAD
- 183 POST
- 190 SOLAR MODERN
- 198 SOLAR CLASSIC
- 200 LAMPS

UMBERTA-EMERGENCY

BULKHEAD



EMERGENCY

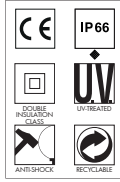
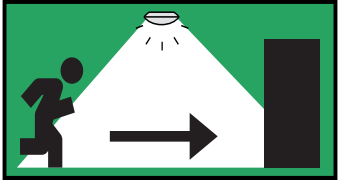

UMBERTA EMERGENCY - LED VERSIONS					
EMERGENCY KIT	MODE	POWER	LUMINOUS FLUX (ID TOTAL) (Lp-TD)	VOLTAGE RANGE	COLOUR TEMPERATURE
	NORMAL	15W	2000 lm	220-240V 50/60 Hz	4000K
	EMERGENCY (min 3 hours)	2,4W	250 lm	220-240V 50/60 Hz	4000K

UMBERTA LED MAINTAINED EMERGENCY

LED 4000K 1B3.000.EM1

PRODUCT TYPE	Wall and Ceiling bulkhead with Emergency kit
OPERATING VOLTAGE	220~240 vAC
LUMINOUS FLUX & POWER	2000 lumen (Normal mode), 15W 250 lumen (Emergency mode), 2.4W
LED TYPE	Edison SMD 2835, 4000 K
CRI	>80Ra
PF (POWER FACTOR)	>0.95
BEAM ANGLE	120°
OPERATING TEMPERATURE	0~50°C
BATTERY	Ni-MH, BK370Ah3.6V, Panasonic (3.5Ah, 3.6V)
BATTERY OPERATING TIME	min 3 hours (250 lumen)
BATTERY CHARGING TIME	24 hours
Drivers Standards	EN 61347-1, EN 61347-2-7, EN 61347-2-13, EN 62384, EN 60598-2-22 EN 55015, EN61547, EN 61000-3-2, EN 61000-3-3
Battery Standards	EN 5501-1, EN 61000, EN 55014-2

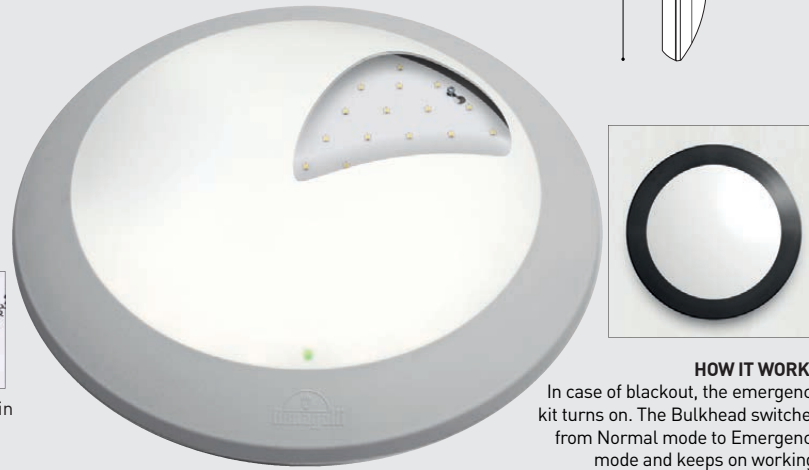
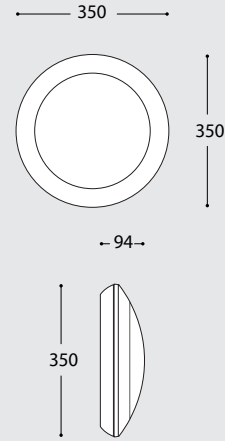

Provided with built-in test button to check battery status.

HOW IT WORKS
In case of blackout, the emergency kit turns on. The Bulkhead switches from Normal mode to Emergency mode and keeps on working.



Green Led: identifies the emergency light and shows that the system is operating correctly.



BULKHEAD

UMBERTA - SENSOR

SENSOR

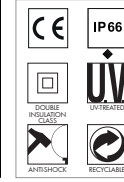
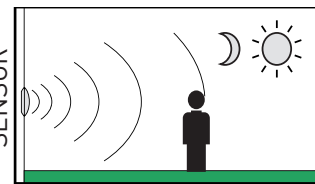

UMBERTA CCT LED VERSIONS					
LAMP	POWER	LUMINOUS FLUX (ID TOTAL)	VOLTAGE RANGE	CCT SETTABLE	
	11,3W	1510 lm	100-240V 50/60 Hz	6500K/4000K/2700K	≈100W INCANDESCENT
	17W	2350 lm	100-240V 50/60 Hz	6500K/4000K/2700K	≈150W INCANDESCENT

UMBERTA MOTION & DAYLIGHT SENSOR

E27 WITH SENSOR))	1B3.000.ES7
2x E27 WITH SENSOR))	1B3.000.ES8
11,3W LED GX53 WITH SENSOR)) <input type="checkbox"/> CCT SET	1B3.000.BSK
17W LED GX53 WITH SENSOR)) <input type="checkbox"/> CCT SET	1B3.000.ESK

Product Type	Wall and Ceiling bulkhead with Motion&Daylight sensor
Sensor operating voltage	220-240 vAC (120v version available on demand)
Version	GX53 LED, E27, 2xE27
Sensor Operating Temperature	-10° +60°C
Detection angle	30° - 150°
Fields of detection	1 - up to 5 mt (adjustable)

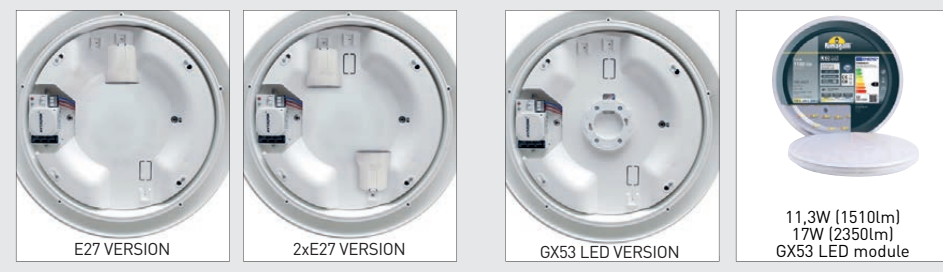
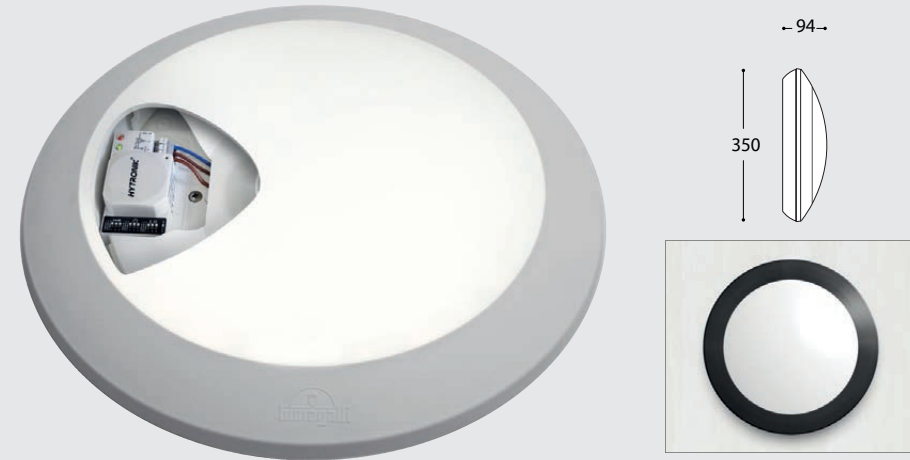
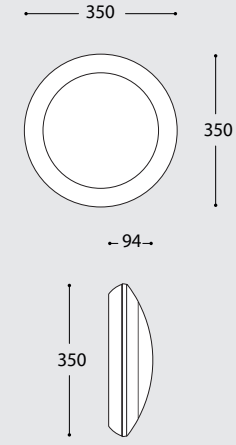

10	REIVAL
36	GARDEN SMALL
52	GARDEN MEDIUM
72	GARDEN LARGE
88	HALF LANTERN
90	BOLLARD
96	BOLLARD
118	DOWNLIGHT
126	UP&DOWN
138	FLOODLIGHT
148	IN-GROUND
154	BRICKLIGHT
164	BULKHEAD
183	POST
190	SOLAR MODERN
198	SOLAR CLASSIC
200	LAMPS

GELMI
BULKHEAD



MADE IN ITALY

1G3.000



SUPPLIED FULLY PRE-WIRED

GX53 LED	E27	E27 + SENSOR
		WITH SENSOR (E57)

CCT SETTABLE

SDCM <6

2700 K 4000 K 6500 K



LED BULKHEAD GX53					
LAMP	POWER	LUMINOUS FLUX (Φ TOTAL)	VOLTAGE RANGE	CCT SETTABLE	
	11,3W	1510 lm	100-240V 50/60 Hz	6500K/4000K/2700K	=100W INCANDESCENT
	17W	2350 lm	100-240V 50/60 Hz	6500K/4000K/2700K	=150W INCANDESCENT

AVAILABLE COLORS			
RESIN BODY (MOULDED COLOURS)		DIFFUSER	
BLACK (A)	GREY (L)	WHITE (W)	OPAL (Y)

GELMI

		E27	1G3.000.E27
		GX53 LED 11,3W	1G3.000.B1K
		GX53 LED 17W	1G3.000.E1K

Master box: 16pcs

GELMI-EL

		E27	2G3.000.E27
		GX53 LED 11,3W	2G3.000.B1K
		GX53 LED 17W	2G3.000.E1K

Master box: 16pcs

GELMI-GR

		E27	3G3.000.E27
		GX53 LED 11,3W	3G3.000.B1K
		GX53 LED 17W	3G3.000.E1K

Master box: 16pcs

GARDEN CLASSIC

- 10 REIVAL
- 36 GARDEN SMALL
- 52 GARDEN MEDIUM
- 72 GARDEN LARGE
- 88 HALF LANTERN
- 90 BOLLARD
- 96 BOLLARD
- 118 DOWNLIGHT
- 126 UP&DOWN

GARDEN MODERN

- 138 FLOODLIGHT
- 148 IN-GROUND
- 154 BRICKLIGHT
- 164 BULKHEAD
- 183 POST

SOLAR

- 190 SOLAR MODERN
- 198 SOLAR CLASSIC
- 200 LAMPS

DANZI
BULKHEAD



MADE IN ITALY



1D3.000

SUPPLIED FULLY PRE-WIRED

GX53 LED	E27	E27 + SENSOR

WITH SENSOR 220-240V (.ES7)

CCT SETTABLE

SDCM <6

2700 K 4000 K 6500 K



LED BULKHEAD GX53					
LAMP	POWER	LUMINOUS FLUX (Φ TOTAL)	VOLTAGE RANGE	CCT SETTABLE	
	11,3W	1510 lm	100-240V 50/60 Hz	6500K/4000K/2700K	=100W INCANDESCENT
	17W	2350 lm	100-240V 50/60 Hz	6500K/4000K/2700K	=150W INCANDESCENT

AVAILABLE COLORS			
RESIN BODY (MOULDED COLOURS)		DIFFUSER	
BLACK (A)	GREY (L)	WHITE (W)	OPAL (Y)

DANZI

		E27	1D3.000.E27
		GX53 LED 11,3W	1D3.000.B1K
		GX53 LED 17W	1D3.000.E1K

Master box: 16pcs

DANZI-VE

		E27	2D3.000.E27
		GX53 LED 11,3W	2D3.000.B1K
		GX53 LED 17W	2D3.000.E1K

Master box: 16pcs

DANZI-GR

		E27	3D3.000.E27
		GX53 LED 11,3W	3D3.000.B1K
		GX53 LED 17W	3D3.000.E1K

Master box: 16pcs

10	REIVAL	GARDEN CLASSIC
36	GARDEN SMALL	GARDEN CLASSIC
52	GARDEN MEDIUM	GARDEN CLASSIC
72	GARDEN LARGE	GARDEN CLASSIC
88	HALF LANTERN	GARDEN CLASSIC
90	BOLLARD	GARDEN CLASSIC
96	BOLLARD	GARDEN CLASSIC
118	DOWNLIGHT	GARDEN CLASSIC
126	UP&DOWN	GARDEN MODERN
138	FLOODLIGHT	GARDEN MODERN
148	IN-GROUND	GARDEN MODERN
154	BRICKLIGHT	GARDEN MODERN
164	BULKHEAD	GARDEN MODERN
183	POST	GARDEN MODERN
190	SOLAR MODERN	SOLAR
198	SOLAR CLASSIC	SOLAR
200	LAMPS	SOLAR

STUCCHI BULKHEAD



MADE IN ITALY



1U3.000

CCT SETTABLE

SDCM <6

2700 K 4000 K 6500 K

SUPPLIED FULLY PRE-WIRED

GX53 LED E27 E27 + SENSOR

WITH SENSOR))) 220-240V (E27)

BACKLIT COLOURS AVAILABLE

*To order the backlit version of our bulkhead, the following suffixes have to be added at the end of the code.

CLEAR .CL1 PINK .PK1 BLUE .BU1 GREEN .GN1 ORANGE .OR1



LED BULKHEAD GX53

LAMP	POWER	LUMINOUS FLUX (Φ TOTAL)	VOLTAGE RANGE	CCT SETTABLE	
	11,3W	1510 lm	100-240V 50/60 Hz	6500K/4000K/2700K	=100W INCANDESCENT
	17W	2350 lm	100-240V 50/60 Hz	6500K/4000K/2700K	=150W INCANDESCENT

AVAILABLE COLORS

RESIN BODY (MOULDED COLOURS)

BLACK (A) GREY (L) WHITE (W)

DIFFUSER

OPAL (Y)

STUCCHI

E27 1U3.000.E27

GX53 LED 11,3W 1U3.000.B1K

GX53 LED 17W 1U3.000.E1K

BACKLIT COLOURS VERSION

*To order the backlit version of our bulkhead, the following suffixes have to be added at the end of the code.

CLEAR .CL1 PINK .PK1 BLUE .BU1 GREEN .GN1 ORANGE .OR1

Master box: 16pcs

CECCHI

E27 1H3.000.E27

GX53 LED 11,3W 1H3.000.B1K

GX53 LED 17W 1H3.000.E1K

BACKLIT COLOURS VERSION

*To order the backlit version of our bulkhead, the following suffixes have to be added at the end of the code.

CLEAR .CL1 PINK .PK1 BLUE .BU1 GREEN .GN1 ORANGE .OR1

Master box: 16pcs

RITA

E27 1T3.000.E27

GX53 LED 11,3W 1T3.000.B1K

GX53 LED 17W 1T3.000.E1K

PAINTED COLOURS

*To order the painted colour version of RITA, the following suffixes have to be added at the end of the code.

MOULDED COLOURS

BLACK (A) WHITE (W) ANTIQUE GREEN (V) ANTIQUE BRONZE (B)

Master box: 12pcs

- 10 REVAL
- 36 GARDEN SMALL
- 52 GARDEN MEDIUM
- 72 GARDEN LARGE
- 88 HALF LANTERN
- 90 BOLLARD
- 96 BOLLARD
- 118 DOWNLIGHT
- 126 UP&DOWN
- 138 FLOODLIGHT
- 148 IN-GROUND
- 154 BRICKLIGHT
- 164 BULKHEAD
- 183 POST
- 190 SOLAR MODERN
- 198 SOLAR CLASSIC
- 200 LAMPS

LUCIA BULKHEAD



1R3.000

CCT SETTABLE

SDCM <6

2700 K 4000 K 6500 K

BACKLIT COLOURS AVAILABLE

*To order the backlit version of our bulkhead, the following suffixes have to be added at the end of the code.

CLEAR .CL1 PINK .PK1 BLUE .BU1 GREEN .GN1 ORANGE .OR1

SUPPLIED FULLY PRE-WIRED

GX53 LED E27 E27 + SENSOR

WITH SENSOR))) 220-240V (E27)

SMART PACK AVAILABLE

NEW SMART PACK *

- Save 21% volume
- ECO-friendly packaging
- Film wrapped items

SAVE 21% VOLUME

cbm: 0,15 Master box: 16 pcs



LED BULKHEAD GX53

LAMP	POWER	LUMINOUS FLUX (Φ TOTAL)	VOLTAGE RANGE	CCT SETTABLE	
	11,3W	1510 lm	100-240V 50/60 Hz	6500K/4000K/2700K	=100W INCANDESCENT
	17W	2350 lm	100-240V 50/60 Hz	6500K/4000K/2700K	=150W INCANDESCENT

AVAILABLE COLORS

RESIN BODY (MOULDED COLOURS)			DIFFUSER
BLACK (A)	GREY (L)	WHITE (W)	OPAL (Y)

LUCIA

E27	1R3.000.E27
CCT SET LED GX53 LAMP INCLUDED	
GX53 LED 11,3W	1R3.000.B1K
GX53 LED 17W	1R3.000.E1K

NEW SMART PACK *

E27 1R4.000.E27

REMI/LUCIA

E27	1R3.602.E27
GX53 LED 11,3W	1R3.602.B1K
GX53 LED 17W	1R3.602.E1K

cbm: 0,19 Master box: 16pcs

LUCIA-EL

E27	2R3.000.E27
CCT SET LED GX53 LAMP INCLUDED	
GX53 LED 11,3W	2R3.000.B1K
GX53 LED 17W	2R3.000.E1K

NEW SMART PACK *

E27 2R4.000.E27

REMI/LUCIA-EL

E27	2R3.602.E27
GX53 LED 11,3W	2R3.602.B1K
GX53 LED 17W	2R3.602.E1K

cbm: 0,19 Master box: 16pcs

LUCIA-GD

E27	3R3.000.E27
CCT SET LED GX53 LAMP INCLUDED	
GX53 LED 11,3W	3R3.000.B1K
GX53 LED 17W	3R3.000.E1K

NEW SMART PACK *

E27 3R4.000.E27

REMI/LUCIA-GD

E27	3R3.602.E27
GX53 LED 11,3W	3R3.602.B1K
GX53 LED 17W	3R3.602.E1K

cbm: 0,19 Master box: 16pcs

- 10 REIVAL
- 36 GARDEN SMALL
- 52 GARDEN MEDIUM
- 72 GARDEN LARGE
- 88 HALF LANTERN
- 90 BOLLARD
- 96 BOLLARD
- 118 DOWNLIGHT
- 126 UP&DOWN
- 138 FLOODLIGHT
- 148 IN-GROUND
- 154 BRICKLIGHT
- 164 BULKHEAD
- 183 POST
- 190 SOLAR MODERN
- 198 SOLAR CLASSIC
- 200 LAMPS

MADDI BULKHEAD



MADE IN ITALY



1V3.000

CCT SETTABLE

SDCM <6

2700 K 4000 K 6500 K

BACKLIT COLOURS AVAILABLE

*To order the backlit version of our bulkhead, the following suffixes have to be added at the end of the code.

CLEAR .CL1 PINK .PK1 BLUE .BU1 GREEN .GN1 ORANGE .OR1

SUPPLIED FULLY PRE-WIRED

GX53 LED E27 E27 + SENSOR

WITH SENSOR ** 220-240V (E27)

SMART PACK AVAILABLE

NEW SMART PACK *

- Save 21% volume
- ECO-friendly packaging
- Film wrapped items

SAVE 21% VOLUME

cbm: 0,15 Master box: 16 pcs



LED BULKHEAD GX53

LAMP	POWER	LUMINOUS FLUX (Φ TOTAL)	VOLTAGE RANGE	CCT SETTABLE	
	11,3W	1510 lm	100-240V 50/60 Hz	6500K/4000K/2700K	=100W INCANDESCENT
	17W	2350 lm	100-240V 50/60 Hz	6500K/4000K/2700K	=150W INCANDESCENT

AVAILABLE COLORS

RESIN BODY (MOULDED COLOURS)			DIFFUSER
BLACK (A)	GREY (L)	WHITE (W)	OPAL (Y)

MADDI

E27 1V3.000.E27

CCT SET LED GX53 LAMP INCLUDED

GX53 LED 11,3W 1V3.000.B1K
GX53 LED 17W 1V3.000.E1K

NEW SMART PACK *
E27 1V4.000.E27

REMI/MADDI

E27 1V3.602.E27

GX53 LED 11,3W 1V3.602.B1K
GX53 LED 17W 1V3.602.E1K

cbm: 0,19 Master box: 16pcs

MADDI-VE

E27 2V3.000.E27

CCT SET LED GX53 LAMP INCLUDED

GX53 LED 11,3W 2V3.000.B1K
GX53 LED 17W 2V3.000.E1K

NEW SMART PACK *
E27 2V4.000.E27

REMI/MADDI-VE

E27 2V3.602.E27

GX53 LED 11,3W 2V3.602.B1K
GX53 LED 17W 2V3.602.E1K

cbm: 0,19 Master box: 16pcs

MADDI-HL

E27 3V3.000.E27

CCT SET LED GX53 LAMP INCLUDED

GX53 LED 11,3W 3V3.000.B1K
GX53 LED 17W 3V3.000.E1K

NEW SMART PACK *
E27 3V4.000.E27

REMI/MADDI-HL

E27 3V3.602.E27

GX53 LED 11,3W 3V3.602.B1K
GX53 LED 17W 3V3.602.E1K

cbm: 0,19 Master box: 16pcs

- 10 REVIVAL
- 36 GARDEN SMALL
- 52 GARDEN MEDIUM
- 72 GARDEN LARGE
- 88 HALF LANTERN
- 90 BOLLARD
- 96 BOLLARD
- 118 DOWNLIGHT
- 126 UP&DOWN
- 138 FLOODLIGHT
- 148 IN-GROUND
- 154 BRICKLIGHT
- 164 BULKHEAD
- 183 POST
- 190 SOLAR MODERN
- 198 SOLAR CLASSIC
- 200 LAMPS

BEPPE 400/VIVI 400

POST



MADE IN ITALY



NEW HIGH POWER LED

INDOOR & OUTDOOR USE

+80°C
-30°C

90% HUMIDITY

VOLTAGE SURGE RESISTANT

30W (3620 lm)

50W (6550 lm)

More details at page 202



POST EKTOR / BEPPE-VIVI 400

BEPPE-VIVI 400 HIGH POWER LED					
LAMP	POWER	LUMINOUS FLUX UP TO	VOLTAGE RANGE	COLOUR TEMPERATURE	
HIGH POWER LED E27	30W	3620 lm	100-240V 50/60 Hz	3000K/ 4000K	=70W HQI-SO
HIGH POWER LED E27	50W	6550 lm	100-240V 50/60 Hz	4000K 3000K	=70W HQI-SO

AVAILABLE COLORS			
RESIN BODY (MOULDED COLOURS)			DIFFUSER
BLACK (A)	GREY (L)	WHITE (W)	CLEAR (X) OPAL (Y)

EKTOR 2500 / BEPPE400		
30W LED	CCT SET	P50.361.Q1K
50W LED	4000K 3000K	P50.361.H1L P50.361.H1R

EKTOR 2500 MIDIPILAR / VIVI400 1L		
30W LED	CCT SET	V50.361.A10.Q1K
50W LED	4000K 3000K	V50.361.A10.H1L V50.361.A10.H1R

HIGH POWER LED VERSION

HIGH POWER LED VERSION

- 10 REIVAL
- 36 GARDEN SMALL
- 52 GARDEN MEDIUM
- 72 GARDEN LARGE
- 88 HALF LANTERN
- 90 BOLLARD
- 96 BOLLARD
- 118 DOWNLIGHT
- 126 UP&DOWN
- 138 FLOODLIGHT
- 148 IN-GROUND
- 154 BRICKLIGHT
- 164 BULKHEAD
- 183 POST
- 190 SOLAR MODERN
- 198 SOLAR CLASSIC
- 200 LAMPS

FORTUNATO
for details see pag.193



BISSO/ROSETTA
for details see pag.199

FELICE 200
for details see.195



FELICE 400
for details see pag.195

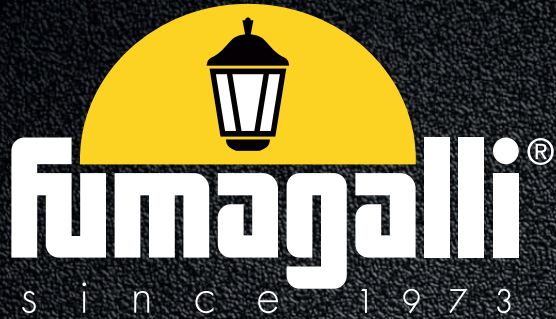

PROMO GARDEN 2024 - SOLAR RANGE

**SOLAR MODULE
NEW VERSION**

JOSEPHA 800
for details see pag.191

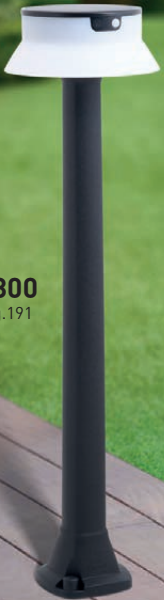

FIORINA
for details see pag.193



MINILOT/ROSETTA
for details see pag.199



JOSEPHA 160
for details see pag.191



TÜV CERTIFIED LED MODULES



SWITCH FOR ON/OFF and BATTERY ACTIVATION

SOLAR PANEL

- Panel 2W/5V
- Monocrystalline
- High resistant tempered glass



MATERIAL

- PC material suitable for outdoor use
- UV rays stabilized
- Anti shock



REPLACEABLE BATTERY

- Quick and easy battery replacement
- LiFePO4 IFR 26650 3,4Ah-3,2V
- No risk of explosion



PIR SENSOR

- Detection angle 120°
- Fields of detection up to 5m
- Active for 25 sec.



LENS

- Frosted color lens reducing dazzle.
- Made of UV rays stabilized resin material to avoid yellowing process.
- Very compact and slim design for a better light distribution and for improving the light efficiency.

LED

- Power absorption of the led plate 2,7W (at 100% light)
- LED chips connected by pure gold wires able to withstand at the highest and lowest temperatures and granting a lumens maintenance factor > 80%.
- SMD 2835 LED.
- 4000K CRI>80



NEW VERSION



- SOLAR PANEL COVER IN HIGH RESISTANT TEMPERED GLASS
- IP65 IMPROVED IP PROTECTION
- SAME SWITCH FOR ON/OFF AND BATTERY ACTIVATION
- VERY SIMPLE USE

IP65

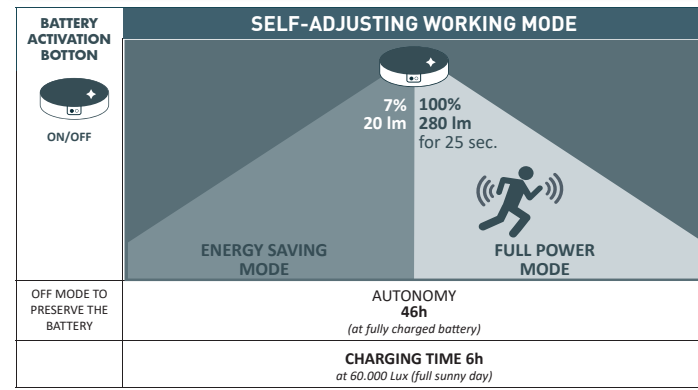

REPLACEABLE BATTERY		
	<ul style="list-style-type: none"> • LiFePO4 IFR 26650E3400, 3,2V • No risk of explosion • Longer Lifetime 	
MOTION SENSOR		
	<ul style="list-style-type: none"> • PIR Sensor control • Detection angle 120° • Fields of detection up to 5mt • Active for 25 sec. 	
SOLAR PANEL		
	<ul style="list-style-type: none"> • 5V/2W • Monocrystalline • High resistant tempered glass 	



SOLAR

JOSEPHA

SOLAR MODERN



MADE IN ITALY

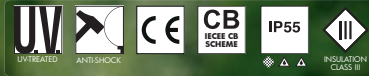
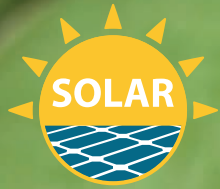

JS1.242.S3LOP2

SOLAR MODULE NEW VERSION



REFLECTOR - OPTIONAL COLOURS



SOLAR MODERN

JOSEPHA

JOSEPHA SOLAR				
SOLAR MODULE NEW VERSION	BATTERY LIFE/POK	SOLAR PANEL	LUMINOUS FLUX	COLOUR TEMPERATURE
	3,4Ah 3,2V	5V/2W	max 280Lm	4000K

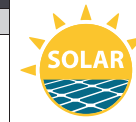

AVAILABLE COLORS			
RESIN BODY (MOULDED COLOURS)			REFLECTOR (STANDARD VERSION)
BLACK (A)	GREY (L)	WHITE (W)	OPAL (LOP2)

JOSEPHA 160



SOLAR MODULE NEW VERSION

JS1.114.S3LOP2
OPAL REFLECTOR

Master box: **18pcs**

JOSEPHA 800



SOLAR MODULE NEW VERSION

JS1.242.S3LOP2
OPAL REFLECTOR

- 10 REVAL
- 36 GARDEN SMALL
- 52 GARDEN MEDIUM
- 72 GARDEN LARGE
- 88 HALF LANTERN
- 90 BOLLARD
- 96 BOLLARD
- 118 DOWNLIGHT
- 126 UP&DOWN
- 138 FLOODLIGHT
- 148 IN-GROUND
- 154 BRICKLIGHT
- 164 BULKHEAD
- 183 POST
- 190 SOLAR MODERN
- 198 SOLAR CLASSIC
- 200 LAMPS

SOLAR

FIORINA

SOLAR MODERN



FI1.542.S3L

**SOLAR MODULE
NEW VERSION**



SOLAR MODERN

FIORINA/FORTUNATO

FIORINA/FORTUNATO SOLAR				
SOLAR MODULE NEW VERSION	BATTERY LFP/PO4	SOLAR PANEL	LUMINOUS FLUX	COLOUR TEMPERATURE
	3,4Ah 3,2V	5V/2W	max 280Lm	4000K

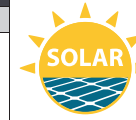

AVAILABLE COLORS		
RESIN BODY (MOULDED COLOURS)		
BLACK (A)	GREY (L)	WHITE (W)

FIORINA



**SOLAR MODULE
NEW VERSION**

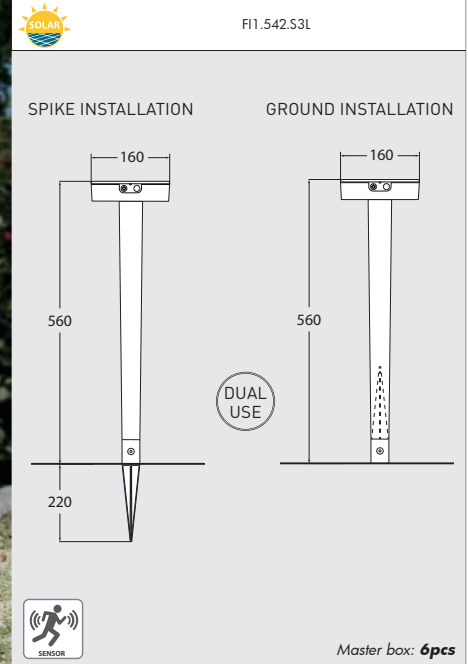

FORTUNATO



**SOLAR MODULE
NEW VERSION**

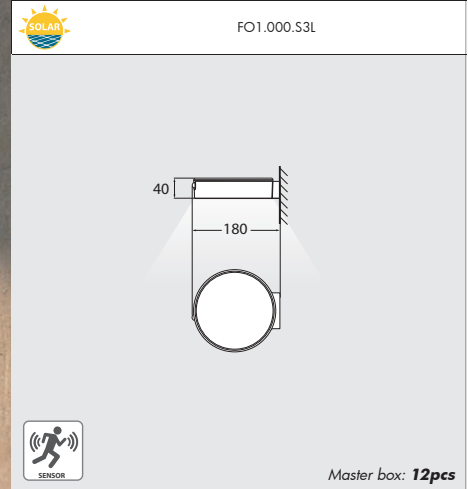

- 10 REVAL
- 36 GARDEN SMALL
- 52 GARDEN MEDIUM
- 72 GARDEN LARGE
- 88 HALF LANTERN
- 90 BOLLARD
- 96 BOLLARD
- 118 DOWNLIGHT
- 126 UP&DOWN
- 138 FLOODLIGHT
- 148 IN-GROUND
- 154 BRICKLIGHT
- 164 BULKHEAD
- 183 POST
- 190 SOLAR MODERN
- 198 SOLAR CLASSIC
- 200 LAMPS

SOLAR

FELICE

SOLAR MODERN



FE1.575.S3LOP2

**SOLAR MODULE
NEW VERSION**



SOLAR MODERN

FELICE

FELICE SOLAR				
SOLAR MODULE NEW VERSION	BATTERY LIFE/POK	SOLAR PANEL	LUMINOUS FLUX	COLOUR TEMPERATURE
	3,4Ah 3,2V	5V/2W	max 280Lm	4000K

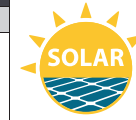

AVAILABLE COLORS			REFLECTOR (STANDARD VERSION)
RESIN BODY (MOULDED COLOURS)			OPAL (OP2)
BLACK (A)	GREY (L)	WHITE (W)	

FELICE 800

FE1.575.S3LOP2
OPAL REFLECTOR

SOLAR MODULE NEW VERSION

730 220 Ø155

Master box: **4pcs**

FELICE 400

FE1.574.S3LOP2
OPAL REFLECTOR

SOLAR MODULE NEW VERSION

330 220 Ø155

Master box: **12pcs**

FELICE 200

FE1.573.S3LOP2
OPAL REFLECTOR

SOLAR MODULE NEW VERSION

180 220 Ø95

Master box: **18pcs**

FELICE 200 SPIKE

FE1.572.S3LOP2
OPAL REFLECTOR

SOLAR MODULE NEW VERSION

180 220 Ø95

Master box: **18pcs**

MADE IN ITALY

- 10 REVAL
- 36 GARDEN SMALL
- 52 GARDEN MEDIUM
- 72 GARDEN LARGE
- 88 HALF LANTERN
- 90 BOLLARD
- 96 BOLLARD
- 118 DOWNLIGHT
- 126 UP&DOWN
- 138 FLOODLIGHT
- 148 IN-GROUND
- 154 BRICKLIGHT
- 164 BULKHEAD
- 183 POST
- 190 SOLAR MODERN
- 198 SOLAR CLASSIC
- 200 LAMPS

SOLAR

SANTINA

SOLAR MODERN



MADE IN ITALY



SL1.257.S3LOP2



SOLAR MODULE
NEW VERSION

REFLECTOR - OPTIONAL COLOURS



SOLAR MODERN

SANTINA

SANTINA SOLAR				
SSOLAR MODULE NEW VERSION	BATTERY LIFE/POK	SOLAR PANEL	LUMINOUS FLUX	COLOUR TEMPERATURE
	3,4Ah 3,2V	5V/2W	max 280Lm	4000K



AVAILABLE COLORS	
RESIN BODY (MOULDED COLOURS)	REFLECTOR (STANDARD VERSION)
BLACK (A)	OPAL (LOP2)



SOLAR MODULE
NEW VERSION

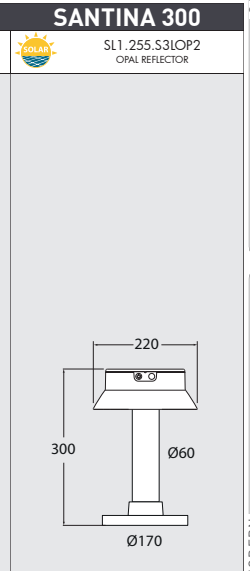
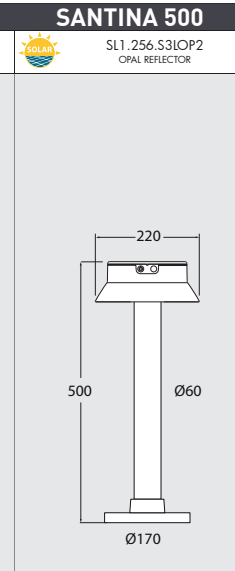
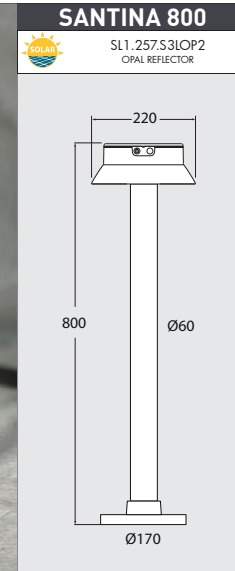

SOLAR MODULE
NEW VERSION

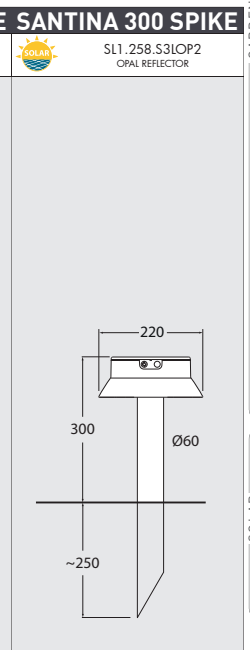
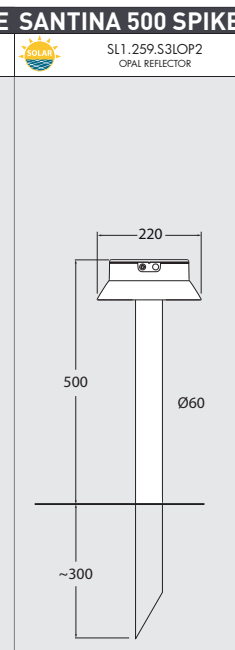
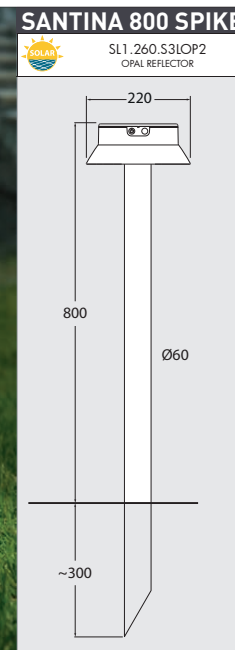

MADE IN ITALY

- 10 REVIVAL
- 36 GARDEN SMALL
- 52 GARDEN MEDIUM
- 72 GARDEN LARGE
- 88 HALF LANTERN
- 90 BOLLARD
- 96 BOLLARD
- 118 DOWNLIGHT
- 126 UP&DOWN
- 138 FLOODLIGHT
- 148 IN-GROUND
- 154 BRICKLIGHT
- 164 BULKHEAD
- 183 POST
- 190 SOLAR MODERN
- 198 SOLAR CLASSIC
- 200 LAMPS

SOLAR

ROSETTA

SOLAR CLASSIC

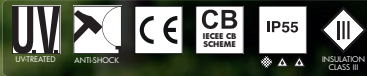

**SOLAR MODULE
NEW VERSION**

R22.151.S3L



SOLAR CLASSIC

ROSETTA

ROSETTA SOLAR				
SOLAR MODULE NEW VERSION	BATTERY LFP/PO4	SOLAR PANEL	LUMINOUS FLUX	COLOUR TEMPERATURE
	3,4Ah 3,2V	5V/2W	max 280Lm	4000K



AVAILABLE COLORS	
RESIN BODY	DIFFUSER
 BLACK (A)	 FROSTED (F)

BISSO/ROSETTA

R22.131.S3L

SOLAR MODULE NEW VERSION

300
340

Master box: **12 pcs**

MINILOT/ROSETTA

R22.111.S3L

SOLAR MODULE NEW VERSION

240
355
Ø150

Master box: **12 pcs**

MIZAR/ROSETTA

R22.151.S3L

SOLAR MODULE NEW VERSION

240
960
Ø50

IAFET/ROSETTA

R22.162.S3L

SOLAR MODULE NEW VERSION

240
935
Ø190

- 10 REVAL
- 36 GARDEN SMALL
- 52 GARDEN MEDIUM
- 72 GARDEN LARGE
- 88 HALF LANTERN
- 90 BOLLARD
- 96 BOLLARD
- 118 DOWNLIGHT
- 126 UP&DOWN
- 138 FLOODLIGHT
- 148 IN-GROUND
- 154 BRICKLIGHT
- 164 BULKHEAD
- 183 POST
- 190 SOLAR MODERN
- 198 SOLAR CLASSIC
- 200 LAMPS



TÜV CERTIFIED LED MODULES



Power surges resistant

- **Wide voltage range (100-240V)** to protect the driver both from voltage droop and voltage overshoot, which are quite frequent in case of outdoor installations.
- **Double 400V capacitors** and multiple resistances to withstand power surges.
- **Silicone paste** to avoid – in case of voltage swings – the vibration of the electronic components of the driver and the consequent risk of components unsoldering.

Heat resistant - Working temperature -30°+80°C

- **Gold wire bonding:** Chips connected by pure gold wires, which are able to withstand at the highest and lowest temperatures and at temperature fluctuations between day and night. The gold wire bonding can grant a lumens maintenance factor > 80%.
- **Silicone paste:** Thermoconductive silicone paste with metal powder inside for helping heat dissipation and avoid overheating problems and for protecting the electronic components in case of high and low temperatures.

Humidity resistant - Weatherproof driver for a longer lifetime

- **Silicone paste:** The driver is fully enclosed in a special silicone paste, which ensures the highest driver protection against moisture and humidity up to 90%, both unavoidable in outdoor installations.



LVD TESTED	LVD Certificate: Fumagalli lamps fulfil the Low Voltage Directive 2014/35/EU, therefore are CE marked and comply with safety requirements like protection against electrical shock, moisture and heat resistance, resistance to flame and ignition.
EMC TESTED	EMC Certificate: Fumagalli lamps meet the Electromagnetic Compatibility Directive 2014/30/EU and its amendments.
NEW ERP	New ERP Attestation of conformity: Fumagalli lamps fulfil the NEW European Ecodesign Directive EU 2019/2020, which sets stricter energy efficiency requirements, new verification tolerances and other factors such as bulb lifetime and warm-up time.
CB	IECEE CB Certificate: Fumagalli lamps meet the International System for Conformity and Certification of Electrotechnical Equipment allowing direct market access in more than 50 countries all over the world.
RoHS REACH COMPLIANT	RoHS REACH compliant: Fumagalli lamps fulfil the RoHS (Restriction of Hazardous Substances) directive 2011/65/EU and its amendments and the REACH regulation (EC) No. 1907/2006, regarding the concentration of Very High Concern Substances (SVHC).

Tested according to :
EN 62560:2012/A1: 2015
IEC/TR 62778:2014
EN 62493:2015



Saudi Standards

Fumagalli lamps meet the Saudi energy efficiency and functionality requirements according to SASO Directive 2870:2018/ADM1:2021. A SASO version packaging with Energy Efficiency label, according to 6.000 hours EEI test report, is available upon request.



TÜV CERTIFIED LED MODULES

E27 LED A60- CCT SETTABLE

POWER	8,5 W		11 W	
	LUMINOUS FLUX (Φ TOTAL)	2700 K 840 lm	4000 K 920 lm	6500 K 920 lm
		1100 lm	1200 lm	1200 lm
SIZE & SOCKET				
VOLTAGE	100-240 V		100-240 V	
FREQUENCY	50/60 Hz		50/60 Hz	
DISPLACEMENT FACTOR	>0,5		>0,7	
PSTLM (NO FLICKER)	< 1		< 1	
SVM	0,4		0,4	
CRI	> 80		> 80	
SDCM	<6		<6	
LIFETIME	25.000 h		25.000 h	
EFFICIENCY CLASS	F		F	
REF. CODE	H.LED.A60.CCT		H2.LED.A60.CCT	

*SASO version available upon request

E27 LED FILAMENT A60

POWER	6,5 W	
	LUMINOUS FLUX (Φ TOTAL)	2700 K
SIZE & SOCKET		
VOLTAGE	100-240 V	
FREQUENCY	50/60 Hz	
DISPLACEMENT FACTOR	>0,5	
CRI	> 80	
SWITCHING CYCLE	> 100.000	
WARM UP TIME	≤ 0,5"	
LIFETIME	25.000 h	
EFFICIENCY CLASS	E	
REF. CODE	H.LED.FIL.3K	

- 10 REVAL
- 36 GARDEN SMALL
- 52 GARDEN MEDIUM
- 72 GARDEN LARGE
- 88 HALF LANTERN
- 90 BOLLARD
- 96 BOLLARD
- 118 DOWNLIGHT
- 126 UP&DOWN
- 138 FLOODLIGHT
- 148 IN-GROUND
- 154 BRICKLIGHT
- 164 BULKHEAD
- 183 POST
- 190 SOLAR MODERN
- 198 SOLAR CLASSIC
- 200 LAMPS

TÜV CERTIFIED LED MODULES

TÜV CERTIFIED LED MODULES



E27 HIGH POWER LED

POWER	15 W		30W	
	LUMINOUS FLUX (Φ TOTAL)	3000 K 4000 K	1545 lm 1690 lm	3325lm 3620 lm
SIZE & SOCKET	 E27		 E27	
VOLTAGE	100-240 V		100-240 V	
FREQUENCY	50/60 Hz		50/60 Hz	
DISPLACEMENT FACTOR	>0,7		>0,9	
PSTLM (NO FLICKER)	<1		<1	
SVM	0,4		0,4	
CRI	> 80		> 80	
SDCM	<6		<6	
SWITCHING CYCLE	30.000		30.000	
WARM UP TIME	< 0,5"		< 1"	
LIFETIME	25.000 h		25.000 h	
EFFICIENCY CLASS	F		E	
REF. CODE	H3.LED.HIP.CCT		H2.LED.HIP.CCT	

CCT SETTABLE
3000 K 4000 K

SILICONE PROTECTION DRIVER

INDOOR & OUTDOOR USE

-30 +80 °C 90% HUMIDITY

VOLTAGE SURGE RESISTANT

ENERGY+

CE LVD EMC CB ERP

TECEE CB SCHEME

COMPLY WITH: EU 2019/2015 EU 2019/2020

IECEE CB CERTIFICATE: SG PSB-LE-03835 SG PSB-LE-03834

TUV SUD

CE LVD EMC CB ERP

TECEE CB SCHEME

COMPLY WITH: EU 2019/2015 EU 2019/2020

IECEE CB CERTIFICATE: SG PSB-LE-02300A1

90% SAVINGS
=35W

30 kWh/1000h

E27 HIGH POWER LED

POWER	50 W		60W	
	LUMINOUS FLUX (Φ TOTAL)	3000 K 4000 K	5850 lm 6550 lm	6800 lm 7600 lm
SIZE & SOCKET	 E27		 E27	
VOLTAGE	100-240 V		100-240 V	
FREQUENCY	50/60 Hz		50/60 Hz	
DISPLACEMENT FACTOR	>0,9		>0,9	
PSTLM (NO FLICKER)	<1		<1	
SVM	0,4		0,4	
CRI	> 80		> 80	
SDCM	<6		<6	
SWITCHING CYCLE	30.000		30.000	
WARM UP TIME	< 1"		< 0,5"	
LIFETIME	25.000 h		25.000 h	
KELVIN	3000 K	4000 K	3000 K	4000 K
EFFICIENCY CLASS	E		E	
REF. CODE	H.LED.HIP.3K	H.LED.HIP.4K	H4.LED.HIP.3K	H4.LED.HIP.4K

CCT SETTABLE
2700 K 4000 K

SILICONE PROTECTION DRIVER

INDOOR & OUTDOOR USE

-30 +80 °C 90% HUMIDITY

VOLTAGE SURGE RESISTANT

ENERGY+

CE LVD EMC CB ERP

TECEE CB SCHEME

COMPLY WITH: EU 2019/2015 EU 2019/2020

IECEE CB CERTIFICATE: SG PSB-LE-03791 SG PSB-LE-03799

TUV SUD

CE LVD EMC CB ERP

TECEE CB SCHEME

COMPLY WITH: EU 2019/2015 EU 2019/2020

IECEE CB CERTIFICATE: SG PSB-LE-02300A1

88% SAVINGS
=50W

50 kWh/1000h

GU10 LED - CCT SETTABLE

POWER	3,5 W	
	LUMINOUS FLUX (Φ TOTAL)	2700 K 4000 K
SIZE & SOCKET	 GU10	
VOLTAGE	100-240 V	
FREQUENCY	50/60 Hz	
DISPLACEMENT FACTOR	>0	
PSTLM (NO FLICKER)	<1	
SVM	0,4	
CRI	> 80	
SDCM	<3	
BEAM ANGLE	43°	
SWITCHING CYCLE	> 25.000	
WARM UP TIME	≤ 0,5"	
LIFETIME	25.000 h	
EFFICIENCY CLASS	F	
REF. CODE	H.LED.GU10.CCT	

CCT SETTABLE
2700 K 4000 K

SILICONE PROTECTION DRIVER

INDOOR & OUTDOOR USE

-30 +80 °C 90% HUMIDITY

VOLTAGE SURGE RESISTANT

ENERGY+

CE LVD EMC CB ERP

TECEE CB SCHEME

COMPLY WITH: EU 2019/2015 EU 2019/2020

IECEE CB CERTIFICATE: SG PSB-LE-02300A1

TUV SUD

CE LVD EMC CB ERP

TECEE CB SCHEME

COMPLY WITH: EU 2019/2015 EU 2019/2020

IECEE CB CERTIFICATE: SG PSB-LE-02300A1

90% SAVINGS
=35W

4 kWh/2000h

GU10 LED - CCT SETTABLE

POWER	6 W	
	LUMINOUS FLUX (Φ TOTAL)	2700 K 4000 K
SIZE & SOCKET	 GU10	
VOLTAGE	100-240 V	
FREQUENCY	50/60 Hz	
DISPLACEMENT FACTOR	>0,5	
PSTLM (NO FLICKER)	<1	
SVM	0,9	
CRI	> 80	
SDCM	<3	
BEAM ANGLE	45°	
SWITCHING CYCLE	> 25.000	
WARM UP TIME	≤ 0,5"	
LIFETIME	25.000 h	
EFFICIENCY CLASS	F	
REF. CODE	H2.LED.GU10.CCT	

CCT SETTABLE
2700 K 4000 K

SILICONE PROTECTION DRIVER

INDOOR & OUTDOOR USE

-30 +80 °C 90% HUMIDITY

VOLTAGE SURGE RESISTANT

ENERGY+

CE LVD EMC CB ERP

TECEE CB SCHEME

COMPLY WITH: EU 2019/2015 EU 2019/2020

IECEE CB CERTIFICATE: SG PSB-LE-02300A1

TUV SUD

CE LVD EMC CB ERP

TECEE CB SCHEME

COMPLY WITH: EU 2019/2015 EU 2019/2020

IECEE CB CERTIFICATE: SG PSB-LE-02300A1

88% SAVINGS
=50W

6 kWh/1000h

GARDEN CLASSIC 10 36 52 72 88 90 96 118 126 138 148 154 164 183 190 198 200
REVAL SMALL MEDIUM LARGE LANTERN BOLLARD DOWNLIGHT UP&DOWN FLOODLIGHT IN-GROUND BRICKLIGHT BULKHEAD POST SOLAR CLASSIC MODERN

TÜV CERTIFIED LED MODULES

TÜV CERTIFIED LED MODULES



GX53 LED Ø75mm- CCT SETTABLE

	POWER	3 W	
	LUMINOUS FLUX (Φ TOTAL)	3000 K	405 lm
		4000 K	410 lm
6500 K		410 lm	
SIZE & SOCKET	<p>GX53</p>		
<p>COMPLY WITH: EU 2019/2015 EU 2019/2020</p>	LUMINOUS FLUX (Φ USE 120°)	335 lm	
	VOLTAGE	100-240 V	
	FREQUENCY	50/60 Hz	
	PSTLM (NO FLICKER)	<1	
	SVM	0,4	
	CRI	> 80	
	SDCM	<6	
	BEAM ANGLE	112°	
	SWITCHING CYCLE	> 30.000	
	WARM UP TIME	0s	
LIFETIME	25.000 h		
EFFICIENCY CLASS	E		
REF. CODE	H.LED.G53.CCT		

GX53 LED Ø180mm- CCT SETTABLE

	POWER	11,3 W	
	LUMINOUS FLUX (Φ TOTAL)	2700 K	1380 lm
		4000 K	1510 lm
6500 K		1510 lm	
SIZE & SOCKET	<p>GX53</p>		
<p>COMPLY WITH: EU 2019/2015 EU 2019/2020</p>	LUMINOUS FLUX (Φ USE 120°)	1100 lm	
	VOLTAGE	100-240 V	
	FREQUENCY	50/60 Hz	
	DISPLACEMENT FACTOR	>0,7	
	PSTLM (NO FLICKER)	<1	
	SVM	0,4	
	CRI	> 80	
	SDCM	<6	
	BEAM ANGLE (FWHM)	110°	
	SWITCHING CYCLE	> 25.000	
WARM UP TIME	≤ 0,5"		
LIFETIME	25.000 h		
EFFICIENCY CLASS	E		
REF. CODE	H4.LED.G53.CCT		

GX53 LED Ø100mm - CCT SETTABLE

	POWER	10W	
	LUMINOUS FLUX (Φ TOTAL)	3000 K	1190 lm
		4000 K	1290 lm
6500 K		1210 lm	
SIZE & SOCKET	<p>GX53</p>		
<p>COMPLY WITH: EU 2019/2015 EU 2019/2020</p>	LUMINOUS FLUX (Φ USE 120°)	975 lm	
	VOLTAGE	100-240 V	
	FREQUENCY	50/60 Hz	
	DISPLACEMENT FACTOR	>0,5	
	PSTLM (NO FLICKER)	<1	
	SVM	0,4	
	CRI	> 80	
	SDCM	<6	
	BEAM ANGLE	112°	
	SWITCHING CYCLE	> 30.000	
WARM UP TIME	0s		
LIFETIME	25.000 h		
EFFICIENCY CLASS	E		
REF. CODE	H3.LED.G53.CCT		

GX53 LED Ø180mm- CCT SETTABLE

	POWER	17 W	
	LUMINOUS FLUX (Φ TOTAL)	2700 K	2070 lm
		4000 K	2350 lm
6500 K		2350 lm	
SIZE & SOCKET	<p>GX53</p>		
<p>COMPLY WITH: EU 2019/2015 EU 2019/2020</p>	LUMINOUS FLUX (Φ USE 120°)	1660 lm	
	VOLTAGE	100-240 V	
	FREQUENCY	50/60 Hz	
	DISPLACEMENT FACTOR	>0,7	
	PSTLM (NO FLICKER)	<1	
	SVM	0,4	
	CRI	> 80	
	SDCM	<6	
	BEAM ANGLE (FWHM)	108°	
	SWITCHING CYCLE	> 25.000	
WARM UP TIME	≤ 0,5"		
LIFETIME	25.000 h		
EFFICIENCY CLASS	E		
REF. CODE	H5.LED.G53.CCT		

GARDEN CLASSIC

10 REVAL

36 GARDEN SMALL

52 GARDEN MEDIUM

72 GARDEN LARGE

88 HALF LANTERN

90 BOLLARD

96 BOLLARD

118 DOWNLIGHT

126 UP&DOWN

GARDEN MODERN

138 FLOODLIGHT

148 IN-GROUND

154 BRICKLIGHT

164 BULKHEAD

183 POST

SOLAR

190 SOLAR MODERN

198 SOLAR CLASSIC

200 LAMPS

TÜV CERTIFIED LED MODULES



TÜV CERTIFIED LED MODULES

R7s LED 78mm- CCT SETTABLE		POWER		3,5W	
SIZE & SOCKET	R7s	LUMINOUS FLUX (Φ TOTAL)	2700 K	325 lm	
		4000 K	365 lm		
		6500 K	365 lm		
		VOLTAGE	100-240 V		
		FREQUENCY	50/60 Hz		
		DISPLACEMENT FACTOR	>0		
		PSTLM (NO FLICKER)	<1		
		SVM	0,4		
		CRI	> 80		
		SDCM	<6		
		SWITCHING CYCLE	45.000		
		WARM UP TIME	≤ 0,5"		
		LIFETIME	25.000 h		
		EFFICIENCY CLASS	F		
		REF. CODE	H7.LED.R7S.CCT		

R7s LED 118mm- CCT SETTABLE		POWER		7,5 W	
SIZE & SOCKET	R7s	LUMINOUS FLUX (Φ TOTAL)	2700 K	680 lm	
		4000 K	775 lm		
		6500 K	790 lm		
		VOLTAGE	100-240 V		
		FREQUENCY	50/60 Hz		
		DISPLACEMENT FACTOR	>0,5		
		PSTLM (NO FLICKER)	<1		
		SVM	0,4		
		CRI	> 80		
		SDCM	<6		
		SWITCHING CYCLE	45.000		
		WARM UP TIME	≤ 0,5"		
		LIFETIME	25.000 h		
		EFFICIENCY CLASS	F		
		REF. CODE	H8.LED.R7S.CCT		

R7s LED 189mm- CCT SETTABLE		POWER		10,5 W	
SIZE & SOCKET	R7s	LUMINOUS FLUX (Φ TOTAL)	2700 K	1000 lm	
		4000 K	1130 lm		
		6500 K	1160 lm		
		VOLTAGE	100-240 V		
		FREQUENCY	50/60 Hz		
		DISPLACEMENT FACTOR	>0,7		
		PSTLM (NO FLICKER)	<1		
		SVM	0,4		
		CRI	> 80		
		SDCM	<6		
		SWITCHING CYCLE	45.000		
		WARM UP TIME	≤ 0,5"		
		LIFETIME	25.000 h		
		EFFICIENCY CLASS	F		
		REF. CODE	H9.LED.R7S.CCT		

G9LED		POWER		1,7 W	
		LUMINOUS FLUX (Φ TOTAL)	3000 K	150 lm	
		4000 K	150 lm		
		SIZE & SOCKET			
		VOLTAGE	100-240 V		
		FREQUENCY	50/60 Hz		
		PSTLM (NO FLICKER)	<1		
		SVM	0,9		
		CRI	> 80		
		SDCM	<6		
		SWITCHING CYCLE	>40.000		
		WARM UP TIME	≤ 0,5"		
		LIFETIME	15.000 h		
		KELVIN	3000 K	4000 K	
		EFFICIENCY CLASS	F		F
		REF. CODE	H.LED.G09.3K		H.LED.G09.4K

*SASO version available upon request.

SOLAR MODULE		SIZE		Ø160		
		ENERGY SAVING MODE		LUMEN	20	
		AUTONOMY		46h		
		FULL POWER MODE		LUMEN	280	
		ACTIVE TIME		25 sec		
		5V/2W				
		Monocrystalline				
		Antishock material				
		High resistant tempered glass				
		6h				
		LiFePO4 IFR26650E3400, 3.2V				
		No Risk of explosion				
		Longer Lifetime				
		Detection angle 120°				
		Fields of detection up to 5 mt				
		Active for 25 sec.				
		1 CIRCUITS		SMD 2835		
		COLOR RENDERING INDEX RA		> 80		
		SDCM		< 6		
		LIFETIME		30.000 h		
		KELVIN		4000 K		
		REF. CODE				H2.LED.SOL.4K

GARDEN CLASSIC 10 REVAL 36 GARDEN SMALL 52 GARDEN MEDIUM 72 GARDEN LARGE 88 HALF LANTERN 90 BOLLARD 96 BOLLARD 118 DOWNLIGHT 126 UP&DOWN 138 FLOODLIGHT 148 IN-GROUND 154 BRICKLIGHT 164 BULKHEAD 183 POST 190 SOLAR MODERN 198 SOLAR CLASSIC

PRODUCT DISPLAY STAND



H.STAND.01

MARKETING SUPPORT

- Coloured images for emphasizing resin material advantages, Italian origin and brand identity.



MODULAR CONSTRUCTION

- Modular design concept with stackable cubes for easy installation and screwless assembly.

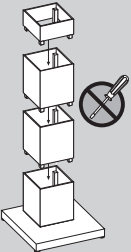

360° DISPLAY

- 4 sides solid and resistant stand in MDF material, complete with basement for bollard fixation.
- The products on display can be personalized at the customer's choice.



EASY CATALOGUE ACCESS

- QR code on every cube for direct access to Fumagalli browsable catalogues.



VERY COMPACT SIZE

- Suitable to be installed in every showroom.
- Occupied surface area: 0,64 sqm only.

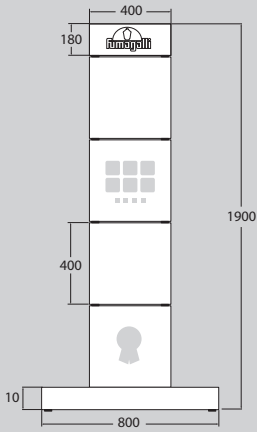

PACKAGING

- Kg.39,2
- mc 0,49 (2 boxes)

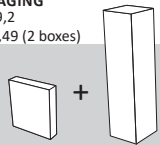

SCAN ME!



VIDEO PRESENTATION



GET INSPIRED
BY OUR
SUGGESTED COMBINATIONS...

BEST SELLER-ALL-IN-ONE

CLASSIC RANGE

MODERN RANGE

REVIVAL RANGE



FRONT VIEW



REAR VIEW

BEST SELLER-MODERN RANGE



FRONT VIEW



REAR VIEW

LOOKING FOR SOMETHING ELSE?

GARDEN RANGE



PROJECT RANGE



TO SEE OUR COMPLETE COLLECTION

Ask for our NEW **General Catalogue 2025** or visit our website at www.fumagalli.it

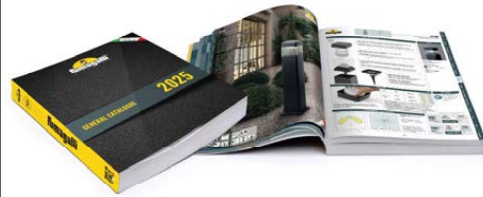

MADE IN ITALY

211 DISTRIBUTORS ALL OVER THE WORLD

190 EMPLOYEES

COME TO VISIT US

COMPONENTS STOCK

LUMINARIES FACTORY

POLES FACTORY

OFFICES, ASSEMBLY, DELIVERY

POLES FACTORY

NEW WAREHOUSE & FACTORY

OPENING SOON!

RESIN MATERIAL ADVANTAGES

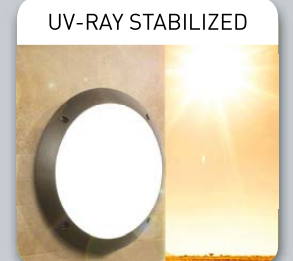
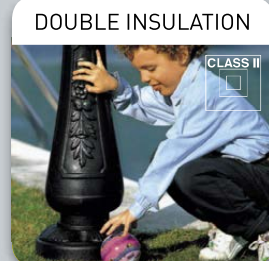
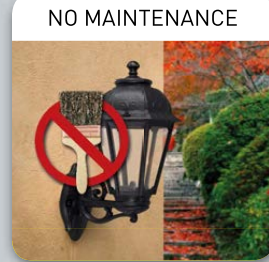

- CE
- RECYCLABLE
- UV TREATED
- CLASS II
- DOUBLE INSULATION
- ANTI-SHOCK
- TEMPERATURE
- ENERGY SAVING
- RESIDENTIAL
- PUBLIC

HOW TO READ THE CODE

DIFFUSER	STRUCTURE	SYSTEM	COLOUR OF THE STRUCTURE	COLOUR OF THE DIFFUSER	ELECTRIFICATION	VARIANT
IDENTIFIES THE DIFFUSER	IDENTIFIES THE STRUCTURE ON WHICH THE DIFFUSER IS MOUNTED (POLE, BRACKET, BASE, SPIKE)	IDENTIFIES THE MULTILIGHT SYSTEM IF PRESENT	IDENTIFIES THE COLOUR OF THE STRUCTURE	IDENTIFIES THE COLOUR OF THE DIFFUSER	IDENTIFIES THE TYPE OF ELECTRIFICATION AND THE EVENTUAL PRESENCE OF BULBS	IDENTIFIES THE PRESENCE OF COMPONENTS SUCH AS AN EVENTUAL LOUVER OR BACKLIT BASE ON THE BULKHEAD RANGE
1R3	613	X20	A	Y	B1L	OR1

MADE IN
ITALY

fumagalli[®]
s i n c e 1 9 7 3

Fumagalli S.r.l.
Via Ca' Bassa, 59
21100 Varese - ITALY
Tel. +39.0332.336353
Fax. +39.0332.336358
E-mail customerservice@fumagalli.it



www.fumagalli.it

