

CINQUE 

24



ENJOY YOUR LIGHT.

CINQUE 

CINQUE präsentiert eine unverwechselbare Leuchten-Kollektion, die ebenso lebendig wie anmutig ist. Qualitativ hochwertige Lichtobjekte, die elegant-stilvolles Design mit modernster Technologie vereinen und sich nicht zuletzt durch beeindruckende Lichteigenschaften auszeichnen. Das Zusammenspiel innovativer Materialien und funktionaler Finesse machen die Leuchten zu etwas ganz Besonderem. So wird Licht nicht nur zum Erlebnis, sondern verleiht Lebensräumen ästhetische und emotionale Qualität.

CINQUE presents a distinctive lighting collection that is as lively as it is graceful. High-quality lighting objects that combine elegant, stylish design with state-of-the-art technology and, last but not least, are characterised by impressive lighting properties. The interplay of innovative materials and functional finesse make the luminaires something very special. In this way, light not only becomes an experience, but also gives living spaces aesthetic and emotional quality.

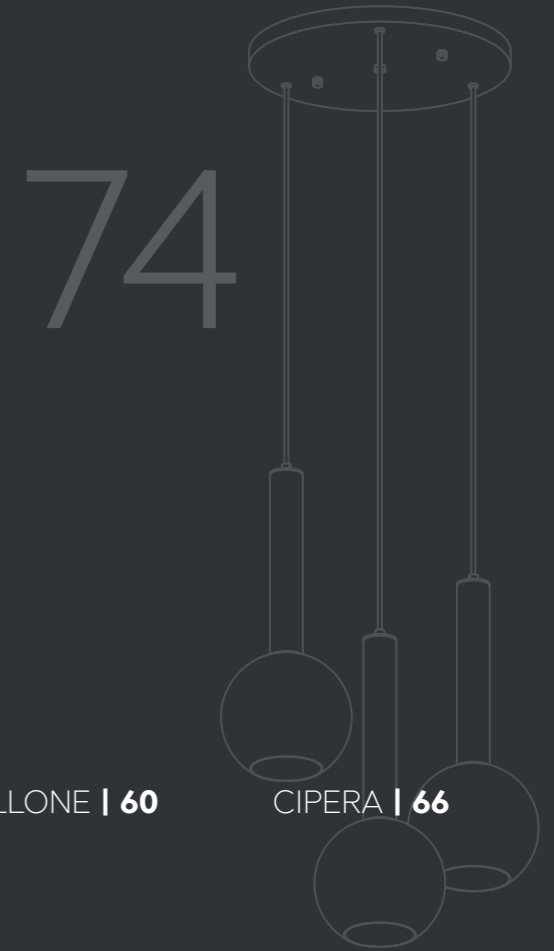
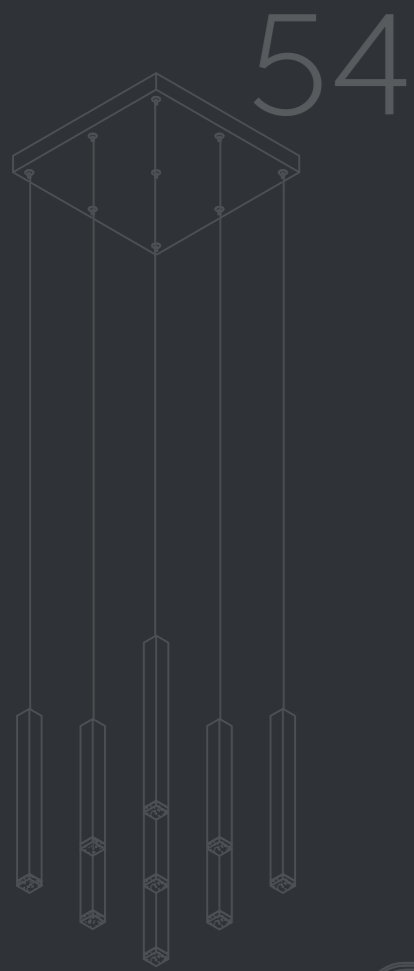

CIFAVO | 6

CIZIONE | 12

CICARA | 18

CINARDI | 26

CIOLA | 32

CICANTO | 40

CIZENZA | 48

CIVETO | 54

CIPALLONE | 60

CIPERA | 66

CILIANA | 74

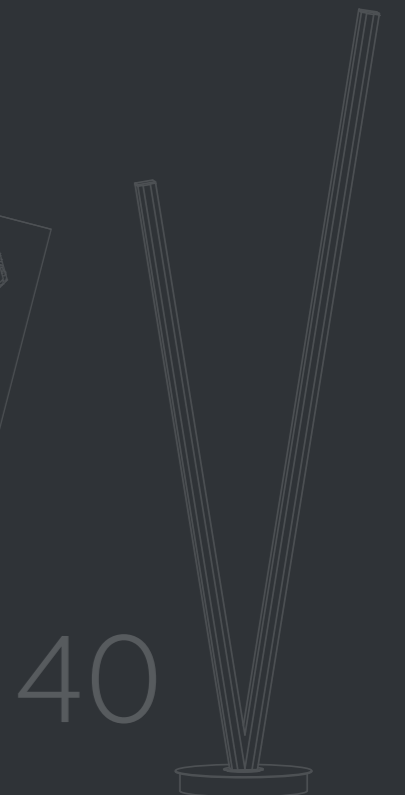
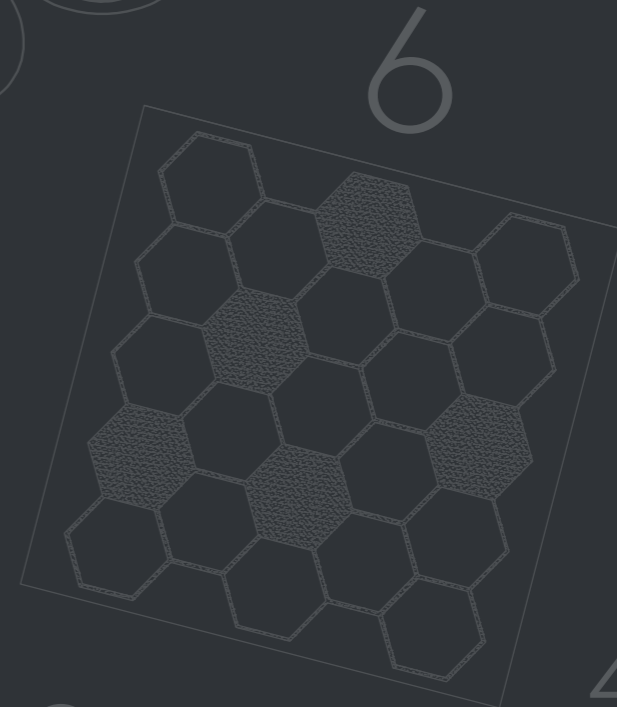
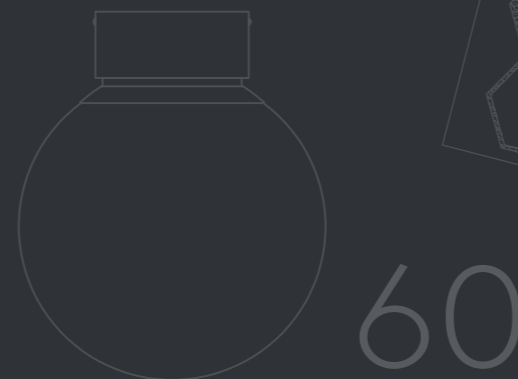
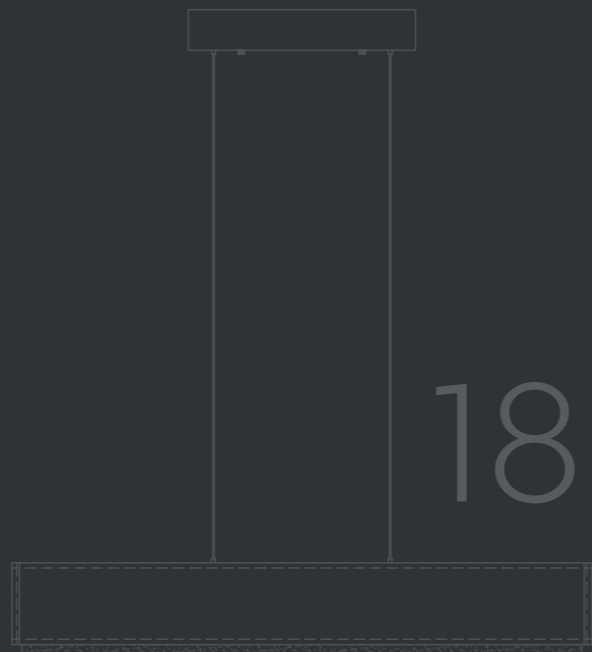
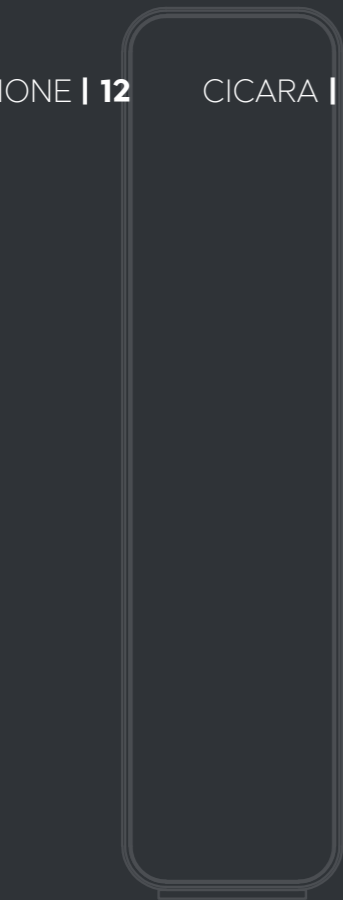

CIFAVO

HARMONIE VON LICHT UND DESIGN
HARMONY OF LIGHT AND DESIGN



Leuchten sind längst nicht mehr nur einfache Lichtquellen. Durch die Symbiose von Technik und Design werden Lichtobjekte zu stilvollen Wohnaccessoires. Das futuristische und kunstvolle Design der Serie CIFAVO demonstriert eindrucksvoll, wie sinnlich Licht gestaltet werden kann. Diese extravaganten Designobjekte akzentuieren Raumdecken und Wände auf einzigartige Weise. Das Besondere: Der Lieferumfang enthält magnetische Dekorelemente, die nach Belieben angeordnet werden können. So entstehen unzählige geometrische Gestaltungsmöglichkeiten und optisch ansprechende Kontraste.

Lights are no longer just simple light sources. The symbiosis of technology and design turns lighting objects into stylish home accessories. The futuristic and artistic design of the CIFAVO series impressively demonstrates how sensually light can be designed. These extravagant design objects accentuate ceilings and walls in a unique way. The special feature: The scope of delivery includes magnetic decorative elements that can be arranged as desired. This creates countless geometric design options and visually appealing contrasts.

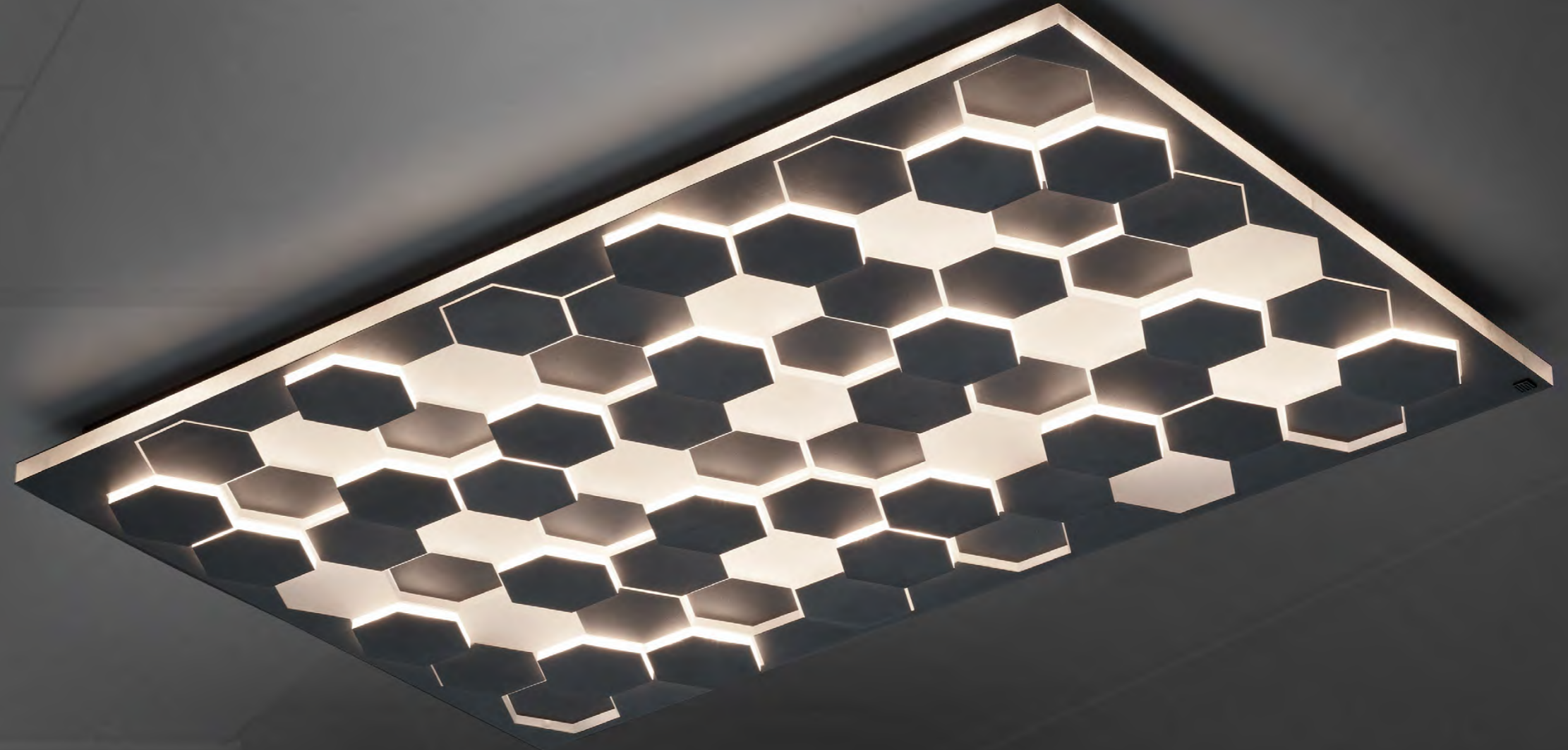

CIFAVO

HARMONIE VON LICHT UND DESIGN
HARMONY OF LIGHT AND DESIGN



Inkl. 9 magnetische Dekoplaten
Incl. 9 magnetic decorative panels

CI-MOTE
ready

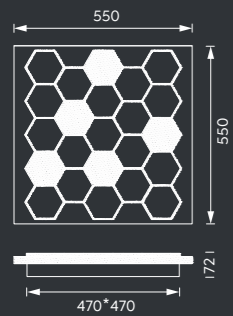
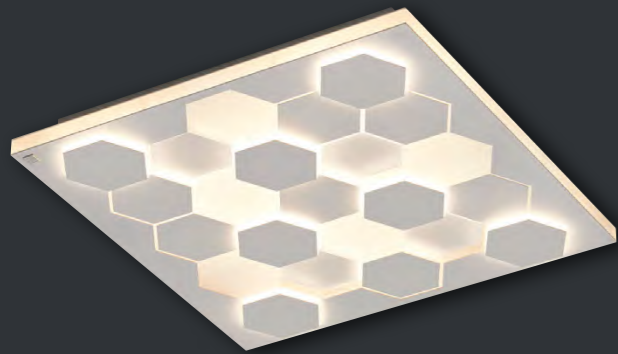

CIFAVO

Wand- und Deckenleuchte, Metall Acryl
Wall and ceiling lamp, metal acryl

↔ 550 mm ↓ 550 mm ↗ 72 mm

SMD-LED, 1 x 40 W, 3780 lm

2.000 - 4.000 K

245410131 | Weiß matt, weiß

White mat, white

245410132 | Schwarz matt, weiß

Black mat, white



CIFAVO

HARMONIE VON LICHT UND DESIGN
HARMONY OF LIGHT AND DESIGN

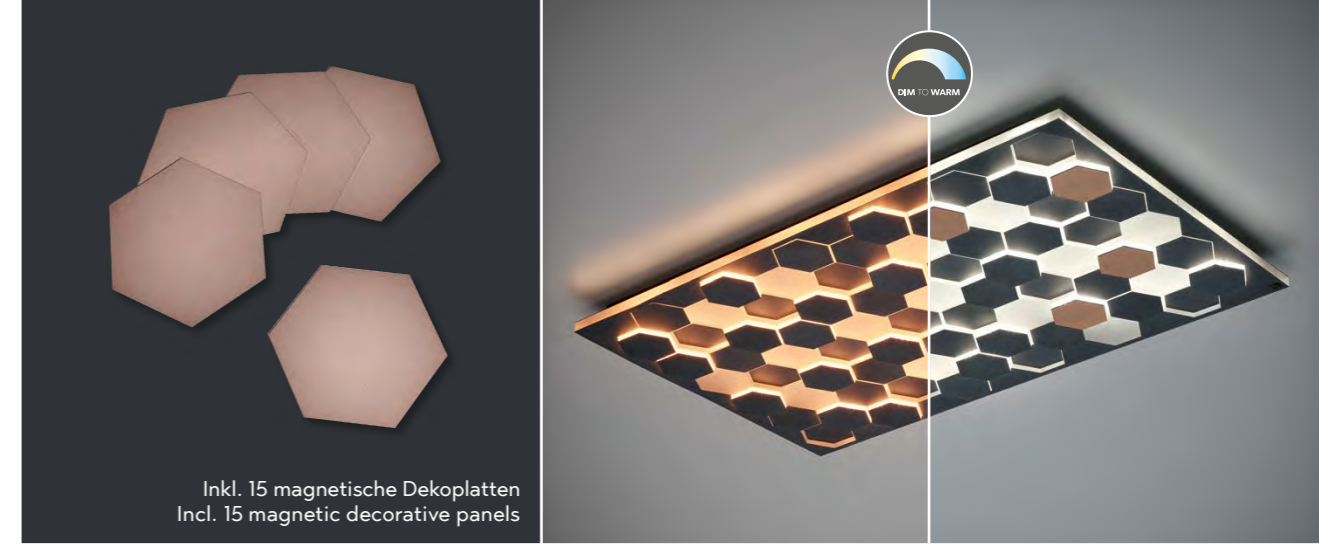

CI-MOTE
ready

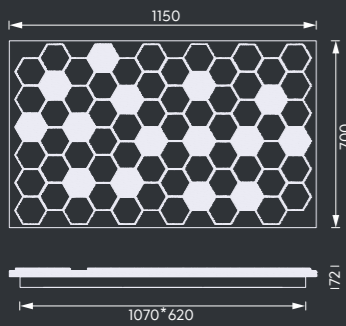
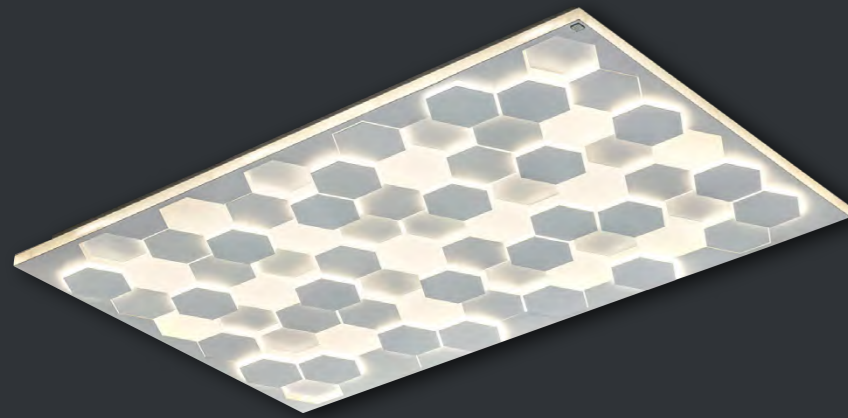

CIFAVO

Wand- und Deckenleuchte, Metall Acryl
Wall and ceiling lamp, metal acryl

↔ 1150 mm ↑ 700 mm ↗ 72 mm

SMD-LED, 1 x 66 W, 6270 lm

2.000 - 4.000 K

245490131 | Weiß matt, weiß
White mat, white

245490132 | Schwarz matt, weiß
Black mat, white



CIZIONE

FUTURISTISCHES DESIGN
FUTURISTIC DESIGN



Die CIZIONE Lichtobjekte sind mit ihrem futuristischen Design die ideale Ergänzung für modern gestaltete Wohnkonzepte. Die hocheffizienten LED-Lichtbänder erzeugen besonders angenehmes, indirektes Licht, dessen warmer Farbton durch die goldene Lackierung der Innenflächen noch verstärkt wird. Selbst im ausgeschalteten Zustand beeindruckt die Leuchten als eigenständige skulpturale Designobjekte und verleihen jedem Raum eine optische Aufwertung.

With their futuristic design, the CIZIONE lighting objects are the ideal addition to modern living concepts. The highly efficient LED light strips produce particularly pleasant, indirect light, the warm color tone of which is further enhanced by the golden finish of the inner surfaces. Even when switched off, the lights impress as independent sculptural design objects and lend any room a visual enhancement.

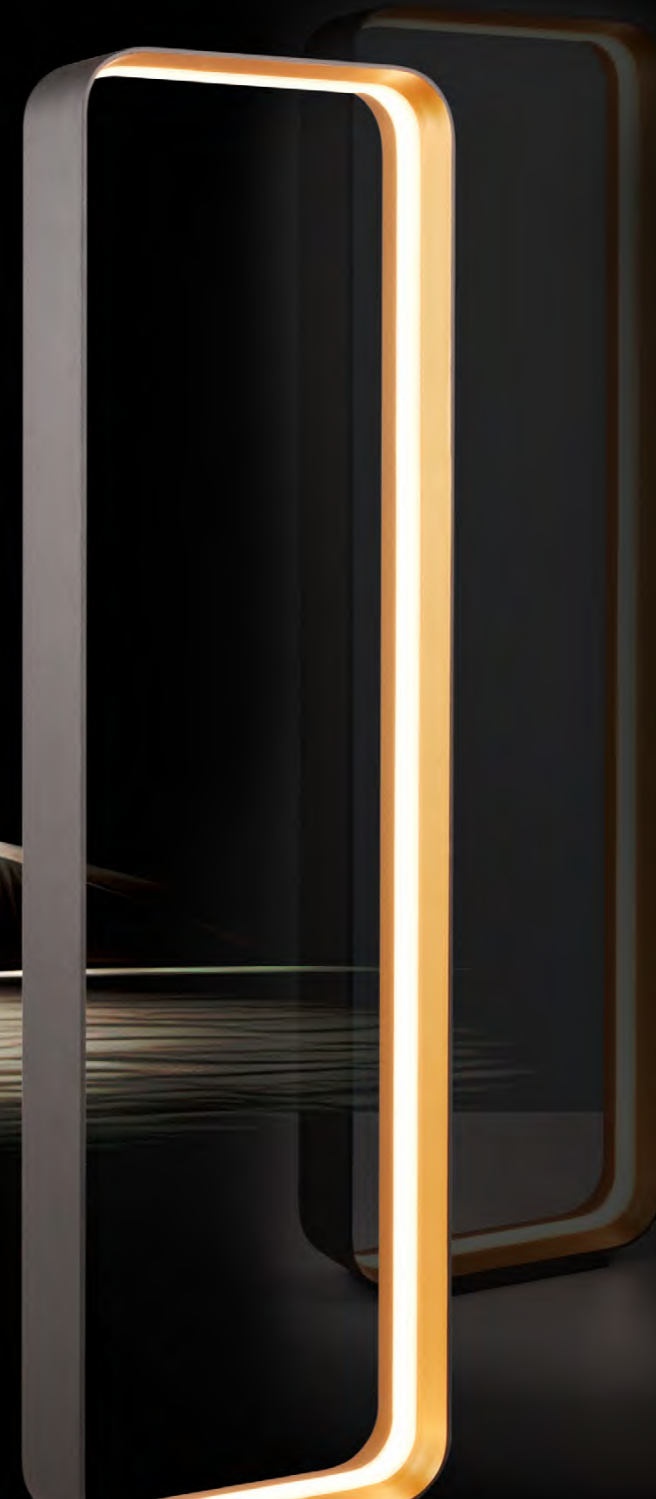

CIZIONE

FUTURISTISCHES DESIGN
FUTURISTIC DESIGN



CI-MOTE
ready

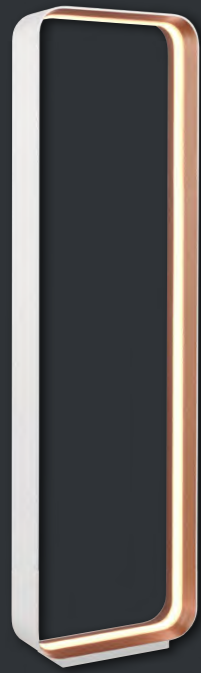

CIZIONE

Stehleuchte, Metall
Floor lamp, metal

↔ 300 mm ↑ 1090 mm ↗ 100 mm
SMD-LED, 1 x 35 W, 4200 lm
2.000 - 4.000 K

444610131 | Weiß matt, Coffee
White mat, coffee

444610132 | Schwarz matt, goldfarbig
Black mat, gold



CIZIONE

FUTURISTISCHES DESIGN
FUTURISTIC DESIGN

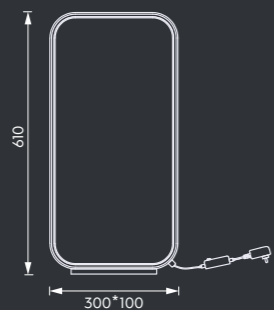
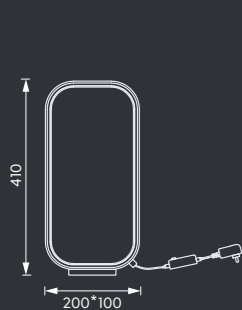

CIZIONE

Tischleuchte, Metall
Table lamp, metal

↔ 200 mm ↑ 410 mm ↗ 100 mm
SMD-LED, 1 x 15 W, 1800 lm
2.000 - 4.000 K

544610131 | Weiß matt, Coffee
White mat, coffee

544610132 | Schwarz matt, goldfarbig
Black mat, gold



CIZIONE

Tischleuchte, Metall
Table lamp, metal

↔ 300 mm ↑ 610 mm ↗ 100 mm
SMD-LED, 1 x 20 W, 2380 lm
2.000 - 4.000 K

544690131 | Weiß matt, Coffee
White mat, coffee

544690132 | Schwarz matt, goldfarbig
Black mat, gold



CICARA

MATERIAL UND DESIGN
MATERIAL AND DESIGN



Die Serie CICARA verkörpert ein minimalistisches Design und zeitlose Moderne auf eine einzigartige Weise. Ihr charakteristisches Merkmal ist die bezaubernde Umhüllung aus hellgrauem Filz-Material. Die Verwendung von Filz schafft eine warme Atmosphäre und ist nicht nur umweltfreundlich, sondern auch raumakustisch wirksam. Daher sind diese Leuchten nicht nur für den Einsatz in den eigenen vier Wänden geeignet, sondern auch in Büros und Besprechungsräumen. Die Serie bietet eine Pendel- und Stehleuchte sowie eine Tisch- und zwei Wandleuchten, die eine Vielzahl von Raumgestaltungsoptionen ermöglichen.

The CICARA series embodies minimalist design and timeless modernity in a unique way. Its characteristic feature is the enchanting cover made of light gray felt material. The use of felt creates a warm atmosphere and is not only environmentally friendly but also effective in terms of room acoustics. These lights are therefore not only suitable for use in the home, but also in offices and meeting rooms. The series offers a pendant and floor lamp as well as a table lamp and two wall lamps, which enable a variety of room design options.



CICARA

MATERIAL UND DESIGN
MATERIAL AND DESIGN



CI-MOTE
ready

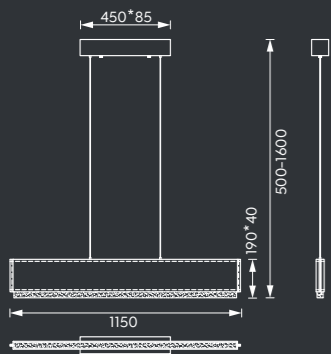
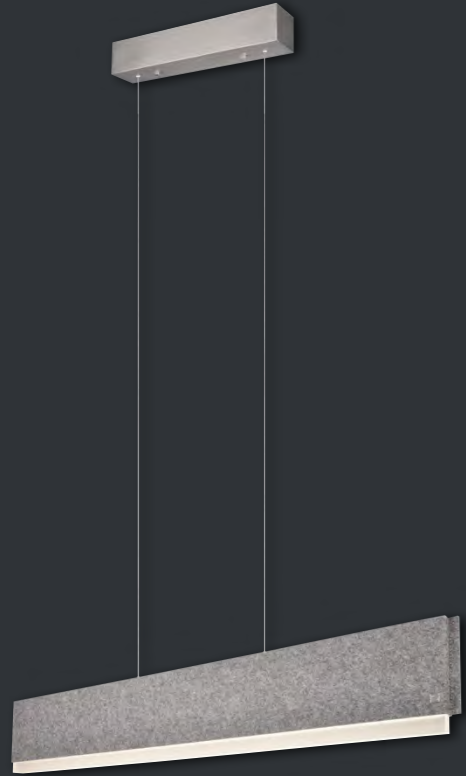

CICARA

Pendelleuchte, Metall Filz Acryl
Pendant lamp, metal felt acryl

↔ 1150 mm ↑ 500 - 1600 mm ↗ 85 mm

SMD-LED, 24 W, 3200 lm

2.000 - 4.000 K

345110207 | Nickel matt, grau, weiß
Nickel mat, grey, white



CICARA

MATERIAL UND DESIGN
MATERIAL AND DESIGN

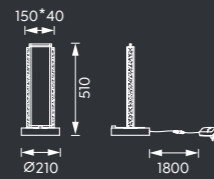
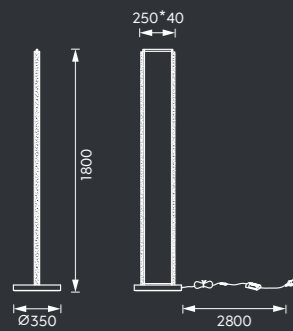
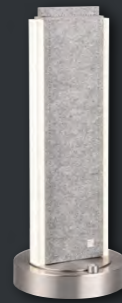
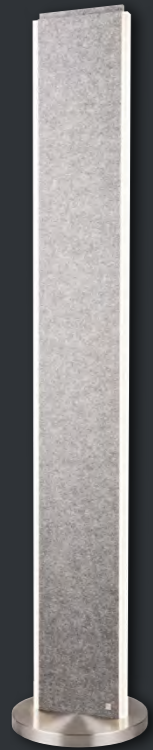

CICARA

Stehleuchte, Metall Filz Acryl
Floor lamp, metal felt acryl

↔ Ø 350 mm ↑ 1800 mm

SMD-LED, 24 W, 2900 lm

3.000 - 4.000 K

445110207 | Nickel matt, grau, weiß
Nickel mat, grey, white



CICARA

Tischleuchte, Metall Filz Acryl
Table lamp, metal felt acryl

↔ Ø 210 mm ↑ 510 mm

SMD-LED, 12 W, 1500 lm

2.000 - 4.000 K

545110207 | Nickel matt, grau, weiß
Nickel mat, grey, white



CICARA

MATERIAL UND DESIGN
MATERIAL AND DESIGN

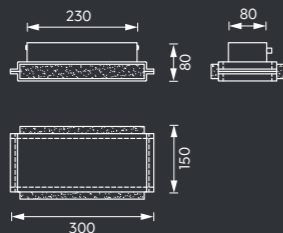
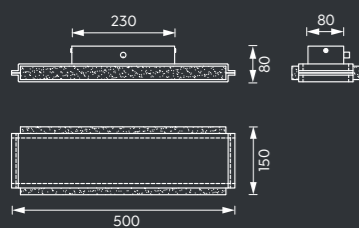
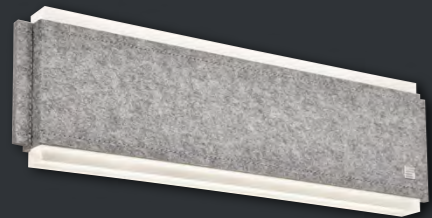
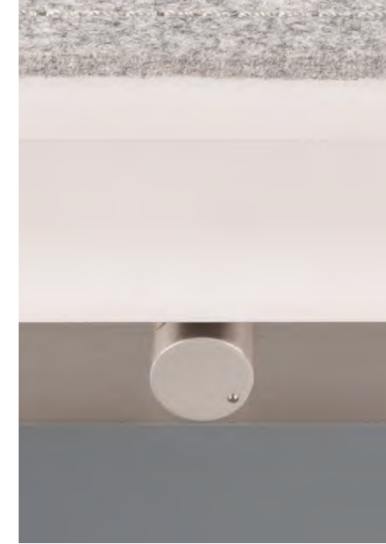

CICARA

Wandleuchte, Metall Filz Acryl
Wall lamp, metal felt acryl

↔ 500 mm ↑ 150 mm ↗ 80 mm

SMD-LED, 14 W, 2000 lm

2.000 - 4.000 K

245190207 | Nickel matt, grau, weiß
Nickel mat, grey, white



CICARA

Wandleuchte, Metall Filz Acryl
Wall lamp, metal felt acryl

↔ 300 mm ↑ 150 mm ↗ 80 mm

SMD-LED, 12 W, 1300 lm

2.000 - 4.000 K

245110207 | Nickel matt, grau, weiß
Nickel mat, grey, white



CINARDI

ELEGANTE LICHTKUNST
ELEGANT LIGHT ART



Die faszinierende Leuchten-Serie CINARDI vereint zeitlose Eleganz mit innovativer LED-Technologie. Die virtuose Formensprache sowie die brillanten Lichteigenschaften vermitteln unbeschwerter Leichtigkeit und sorgen für ein angenehm entspanntes Wohngefühl. Mit einem Durchmesser von 75 cm kommt die Pendelleuchte besonders in großzügig gestalteten Wohnbereichen hervorragend zur Geltung. In Kombination mit der passenden Tisch- und Bodenleuchte entstehen so faszinierende Beleuchtungsszenarien. Die Serie ist in Nickel gebürstet und Mattschwarz erhältlich.

The fascinating CINARDI light series combines timeless elegance with innovative LED technology. The virtuoso design language and brilliant lighting properties convey a carefree lightness and ensure a pleasantly relaxed atmosphere. With a diameter of 75 cm, the pendant light is particularly effective in spacious living areas. In combination with the matching table and floor lamps, it creates fascinating lighting scenarios. The series is available in brushed nickel and matt black.



CINARDI

ELEGANTE LICHTKUNST
ELEGANT LIGHT ART



CI-MOTE
ready

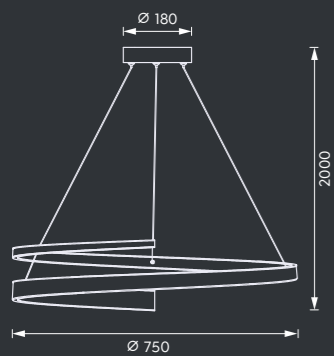

CINARDI

Pendelleuchte, Metall
Pendant lamp, metal
↔ Ø 750 mm ↑ 2000 mm
SMD-LED, 1 x 50 W, 5950 lm
2.000 - 4.000 K
346110107 | Nickel matt · Nickel mat
346110132 | Schwarz matt · Black mat



CINARDI

ELEGANTE LICHTKUNST
ELEGANT LIGHT ART

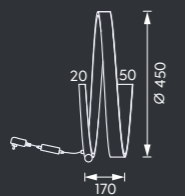
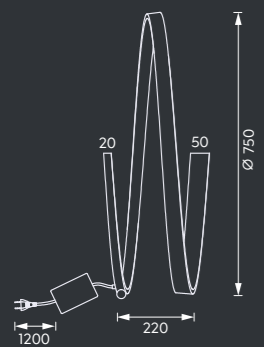

CINARDI

Stehleuchte, Metall
Floor lamp, metal
↔ 220 mm ↑ Ø 750 mm
SMD-LED, 1 x 42 W, 4900 lm
2.000 - 4.000 K
446110107 | Nickel matt · Nickel mat
446110132 | Schwarz matt · Black mat



CINARDI

Tischleuchte, Metall
Table lamp, metal
↔ 170 mm ↑ Ø 450 mm
SMD-LED, 1 x 21 W, 2400 lm
2.000 - 4.000 K
546110107 | Nickel matt · Nickel mat
546110132 | Schwarz matt · Black mat



CIOLA

IMPOSANT UND REPRÄSENTATIV
IMPRESSIVE AND DISTINGUISHED



Imposant und repräsentativ zeigen sich die Leuchten aus der Serie CIOLA. Das perfekte Zusammenspiel von Opulenz und spielerischer Leichtigkeit macht die Leuchten einzigartig und überraschend emotional. So passt sich die Serie gleichermaßen in moderne Räume und auch in klassische Wohnkonzepte ein. Das gilt insbesondere für Wohnbereiche, in denen die Leuchte gerne mal im Mittelpunkt stehen darf. Ob in den Ausführungen Schwarz, Weiß oder edlem Nickel matt, die Serie CIOLA lässt keine Wünsche offen und verspricht maximalen Lichtkomfort.

The lamps from the CIOLA series are impressive and distinguished. The perfect interplay of opulence and playful ease makes the lamps unique and surprisingly evocative. Therefore the series fits equally into modern rooms as well as into classic living concepts. This applies in particular to living areas where the lamp may be the centre of attention. Whether in the black, white or elegant nickel matte, the CIOLA series leaves nothing to be desired and promises maximum lighting comfort.

CIOLA

IMPOSANT UND REPRÄSENTATIV
IMPRESSIVE AND DISTINGUISHED



CI-MOTE
ready

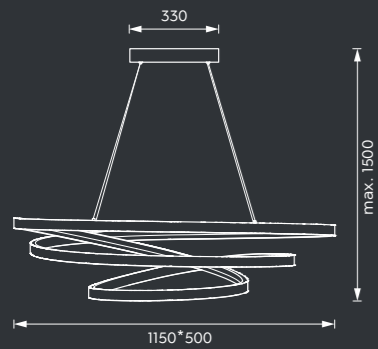

CIOLA

Pendelleuchte, Metall Acryl
Pendant lamp, metal acryl

↔ 1150 mm ↓ 1500 mm

SMD-LED, 100 W, 11.900 lm

2.000 - 4.000 K

377210107 | Nickel matt · Nickel mat

377210132 | Schwarz matt · Black mat



CIOLA

IMPOSANT UND REPRÄSENTATIV
IMPRESSIVE AND DISTINGUISHED

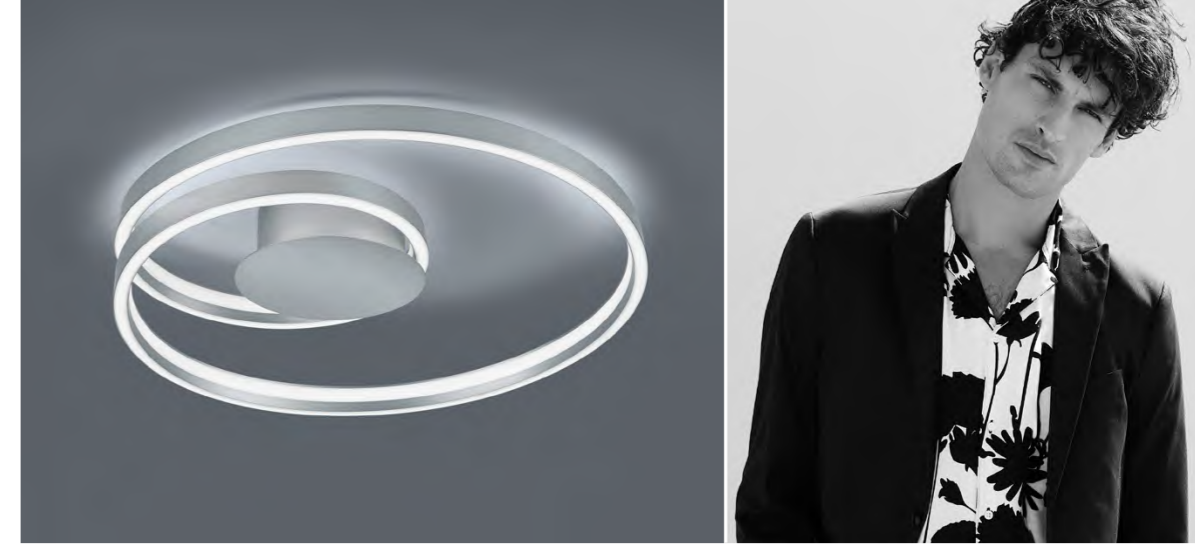

CI-MOTE
ready

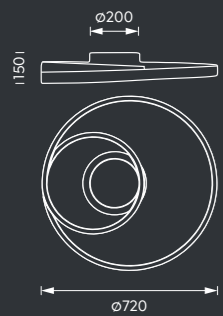

CIOLA

Deckenleuchte, Metall Acryl
Ceiling lamp, metal acryl

↔ Ø 720 mm ↑ 150 mm

SMD-LED, 46 W, 5.400 lm

2.000 - 4.000 K

677210107 | Nickel matt · Nickel mat

677210132 | Schwarz matt · Black mat



CIOLA

IMPOSANT UND REPRÄSENTATIV
IMPRESSIVE AND DISTINGUISHED



CIOLA

Stehleuchte, Metall Acryl
Floor lamp, metal acryl

↔ 500 mm ↑ 1750 mm

SMD-LED, 62 W, 6.400 lm

2.000 - 4.000 K

477210107 | Nickel matt · Nickel mat

477210132 | Schwarz matt · Black mat



CIOLA

Tischleuchte, Metall Acryl
Table lamp, metal acryl

↔ 260 mm ↑ 650 mm

SMD-LED, 21 W, 2.300 lm

2.000 - 4.000 K

577210107 | Nickel matt · Nickel mat

577210132 | Schwarz matt · Black mat



CICANTO

DESIGN AUF GANZER LINIE
DESIGN ALL ALONG THE LINE



Klares und edles Design sowie eine hohe Wertigkeit zeichnen die puristische Leuchtenserie CICANTO aus. Die Decken- und Pendelleuchten überzeugen durch die ausgewogene Kombination von direktem und indirektem Licht. Die Steh- und Tischleuchten wurden so konstruiert, dass sie sich um 360° – also einmal um die eigene Achse – drehen lassen. Ein einzigartiger Bewegungsradius mit höchstem Komfort, der einfach nur begeistert.

The puristic CICANTO luminaire series is characterised by a clear and elegant design and high quality. The ceiling and pendant luminaires convince with their balanced combination of direct and indirect light. The floor and table luminaires have been designed in such a way that they can be rotated 360° – once around their own axis. A unique range of movement with maximum comfort that simply inspires.



CICANTO

DESIGN AUF GANZER LINIE
DESIGN ALL ALONG THE LINE



CI-MOTE
ready

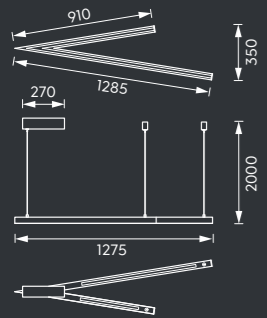
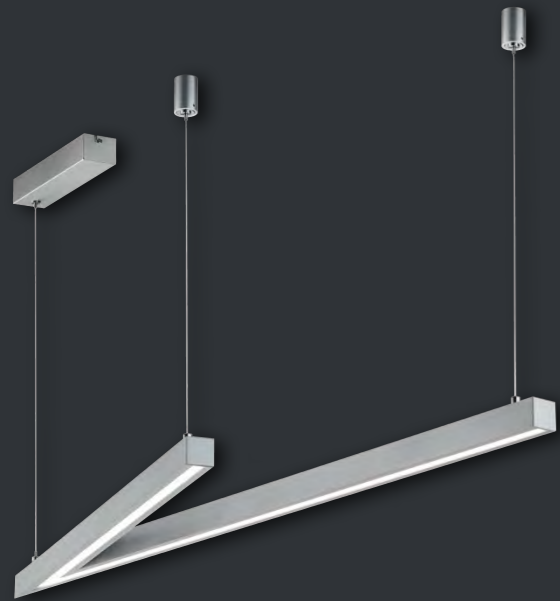

CICANTO

Pendelleuchte, Metall Acryl
Pendant lamp, metal acryl

↔ 1275 mm ↓ 2000 mm ↗ 350 mm

SMD-LED, incl. 1 x 44 W

5.050 lm, 2.000 - 4.000 K

375010107 | Nickel matt · Nickel mat

375010132 | Schwarz matt · Black mat



CICANTO

DESIGN AUF GANZER LINIE
DESIGN ALL ALONG THE LINE



CI-MOTE
ready

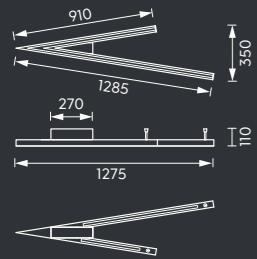
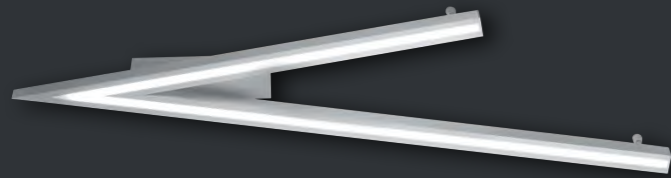

CICANTO

Wand- und Deckenleuchte, Metall Acryl
Wall and ceiling lamp, metal acryl

↔ 1275 mm ↓ 110 mm ↗ 350 mm

SMD-LED, incl. 1 x 44 W

5.050 lm, 2.000 - 4.000 K

675010107 | Nickel matt · Nickel mat

675010132 | Schwarz matt · Black mat



CICANTO

DESIGN AUF GANZER LINIE
DESIGN ALL ALONG THE LINE

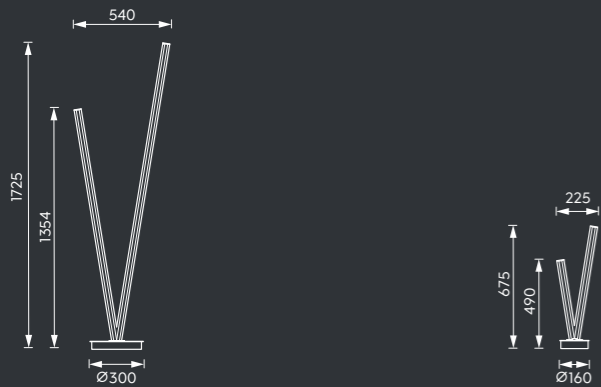
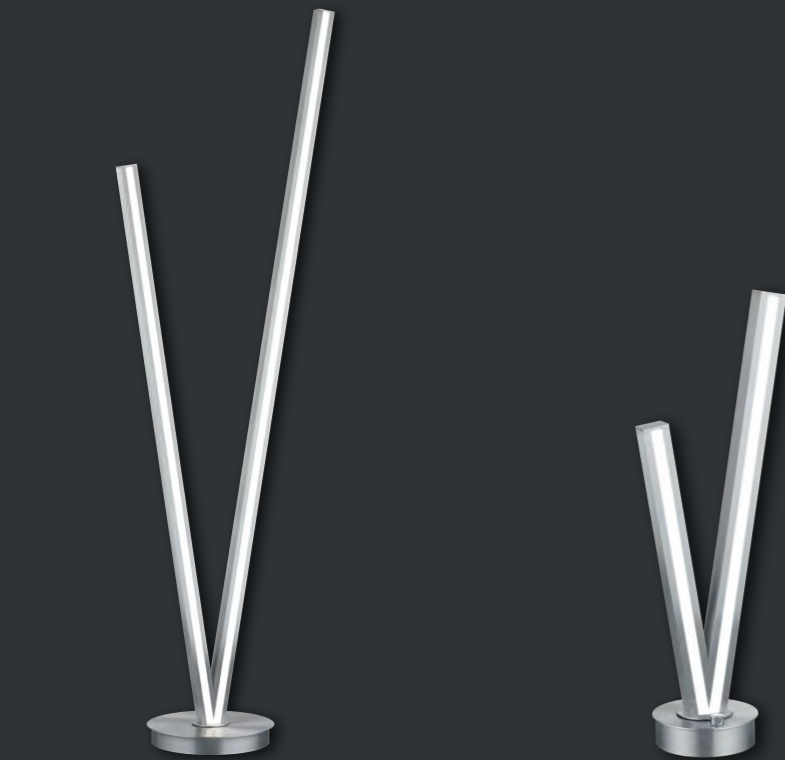

CICANTO

Stehleuchte, Metall
Floor lamp, metal

↔ 540 mm ↓ 1725 mm ↗ 300 mm

SMD-LED, 1 x 45 W, 5.250 lm

2.000 - 4.000 K

475010107 | Nickel matt · Nickel mat

475010132 | Schwarz matt · Black mat



CICANTO

Tischleuchte, Metall
Table lamp, metal

↔ 225 mm ↓ 675 mm ↗ 160 mm

SMD-LED, 1 x 15 W, 1.600 lm

2.000 - 4.000 K

575010107 | Nickel matt · Nickel mat

575010132 | Schwarz matt · Black mat



CIZENZA

MODERNE LEICHTIGKEIT
MODERN EASE



Ein Lichtgenuss der besonderen Art. Die Serie CIZENZA zeigt sich einzigartig in ihrem Design und verkörpert durch ihre elegant geschwungene Form eine moderne Leichtigkeit. Die seitlich verlaufenden LED-Streifen wirken fast schon magisch und vereinen die exzellente Lichtqualität mit dem lebhaften Profil der Leuchten. Um die Freude am Licht zu unterstreichen, ist die Pendelleuchte dank innovativer Lift-Technik kinderleicht höhenregulierbar – Steh- und Tischleuchte lassen sich spielend leicht um 360° drehen. Die Serie ist lieferbar in den Ausführungen Schwarz matt und Weiß matt.

The right lighting provides a special kind of enjoyment. The CIZENZA series is unique in its design and embodies modern ease with its elegantly curved shape. The LED strips running along the side seem almost magical and combine the excellent light quality with the lively profile of the lights. In order to emphasize the enjoyment of light, the pendant lamp is easy to use thanks to innovative lift technology – floor and table lamps can be easily rotated 360°. The series is available in matte black and matte white.

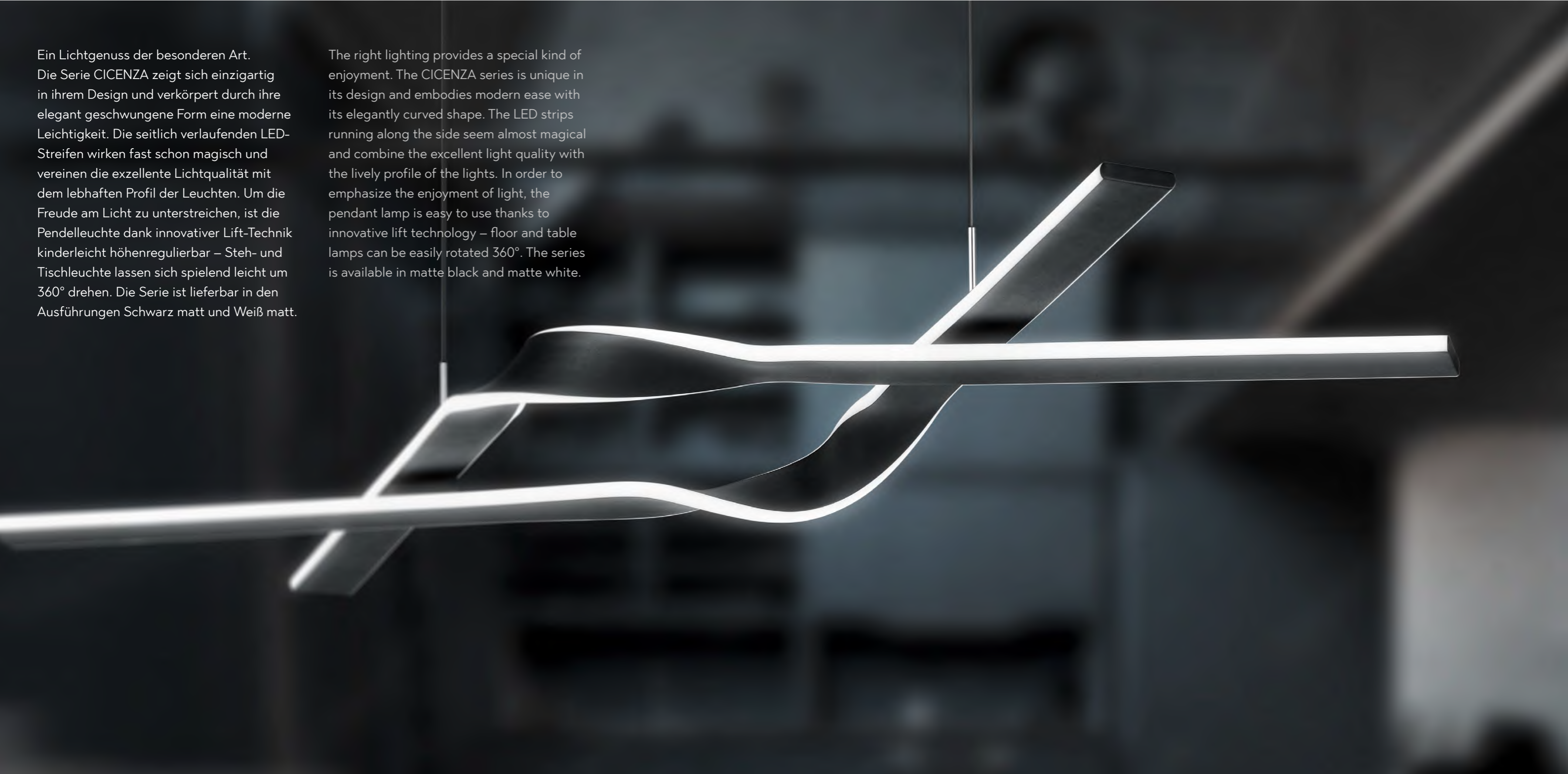

CIZENZA

MODERNE LEICHTIGKEIT
MODERN EASE

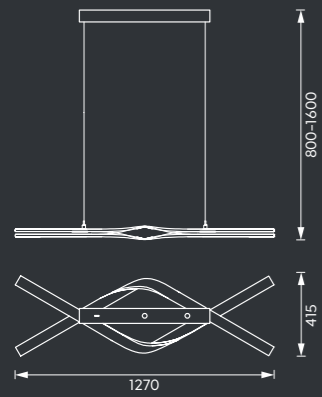
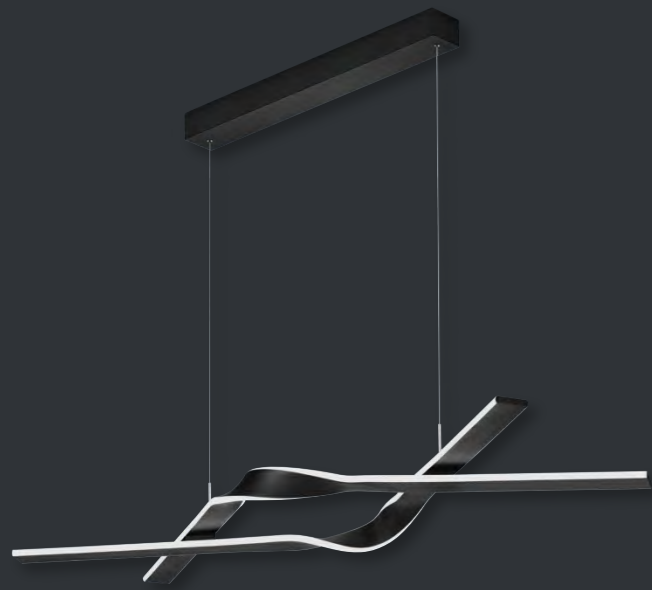

CIZENZA

Pendelleuchte, Metall Acryl
Pendant lamp, metal acryl
↔ 1270 mm ↑ 800-1600 mm ↗ 415 mm
SMD-LED, 52 W, 6.500 lm
2.000 - 4.000 K
378510232 | Schwarz matt · Black mat



CIZENZA

MODERNE LEICHTIGKEIT
MODERN EASE



CIZENZA

Stehleuchte, Metall Acryl
Floor lamp, metal acryl

↔ 530 mm ↑ 1810 mm

SMD-LED, 40 W, 4.700 lm

2.000 - 4.000 K

478510132 | Schwarz matt · Black mat



CIZENZA

Tischleuchte, Metall Acryl
Table lamp, metal acryl

↔ 230 mm ↑ 645 mm

SMD-LED, 12 W, 1.300 lm

2.000 - 4.000 K

578510132 | Schwarz matt · Black mat



CIVETO

ZEITLOSES DESIGN
TIMELESS DESIGN



Modernes, zeitloses Design und schlichte Eleganz verleihen der Leuchtenserie CIVETO einen einmaligen Charme. Die Pendelleuchte ist in zwei verschiedenen Ausführungen erhältlich und fasziniert durch einen gelungenen Mix aus matt schwarzen und hell silbernen Aluminiumoberflächen. Spielend leicht kann die Abhänglänge jedes einzelnen Pendels individuell bestimmt werden. Je nach Lust und Laune bieten sich dadurch zahlreiche Gestaltungsmöglichkeiten. Die passende Deckenleuchte ist vielseitig einsetzbar und räumt Platz für Kombinationen ein.

Modern, timeless design and simple elegance provide the CIVETO light series with a unique charm. The pendant lamp is available in two different versions and captivates with its successful mix of matte black and light silver aluminium surfaces. The hanging length of each individual endulum can be individually adjusted with ease. Depending on your mood, there are numerous design options. The matching ceiling lamp is versatile and allows space for combinations.



CIVETO

ZEITLOSES DESIGN
TIMELESS DESIGN



CI-MOTE
ready

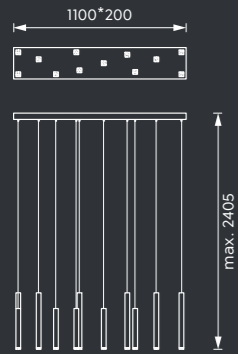

CIVETO

Pendelleuchte, Metall Acryl
Pendant lamp, metal acryl

↔ 1100 mm ↓ max. 2405 mm ↗ 200 mm

SMD-LED, 12 x 3,5 W, 12 x 360 lm

2.000 - 4.000 K

373511232 | Schwarz matt · Black mat



CIVETO

ZEITLOSES DESIGN
TIMELESS DESIGN

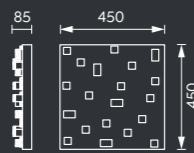
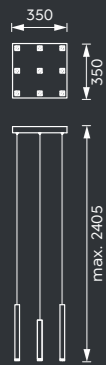

CIVETO

Pendelleuchte, Metall Acryl
Pendant lamp, metal acryl

↔ 350 mm ↓ max. 2405 mm ↗ 350 mm
SMD-LED, 9 x 3,5 W, 9 x 360 lm
2.000 - 4.000 K

373510932 | Schwarz matt · Black mat



CIVETO

Deckenleuchte, Metall Acryl
Ceiling lamp, metal acryl

↔ 450 mm ↓ 85 mm ↗ 450 mm
SMD-LED, 20 x 3 W, 20 x 320 lm
2.000 - 4.000 K

673512032 | Schwarz matt · Black mat



CIPALLONE

KLASSISCHE ÄSTHETIK
CLASSIC AESTHETICS



Die Serie CIPALLONE besticht durch ihre charakteristischen, voluminösen Glaskörper, die ein E27 LED-Leuchtmittel umhüllen. Die gelungene Harmonie von transparentem Rauchglas, mattschwarzem Metall und schlichter Formensprache verleiht diesen Leuchten eine zeitlose Schönheit und Klasse. Die chrombedampften Gläser verleihen nicht nur eine edle Optik, sondern auch für eine zauberhafte, sanfte Lichtverteilung. Ob als einzelne Pendel- oder Deckenleuchte oder als Ensemble in Form einer beeindruckenden Bodenleuchte, die erstklassige Verarbeitung und zeitlosen Designmerkmale verleihen jeder Umgebung eine besondere Note.

The CIPPALLONE series impresses with its characteristic, voluminous glass bodies that encase an E27 LED light source. The successful harmony of transparent smoked glass, matt black metal and simple design lends these lights a timeless beauty and class. The chrome-plated glass not only lends an elegant look, but also ensures magical, soft light distribution. Whether as a single pendant or ceiling light or as an ensemble in the form of an impressive floor light, the first-class workmanship and timeless design features add a special touch to any setting.



CIPALLONE

KLASSISCHE ÄSTHETIK
CLASSIC AESTHETICS

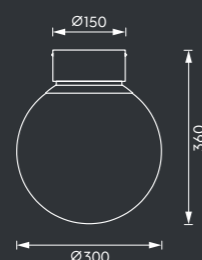
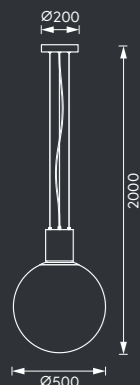

CIPALLONE

Pendelleuchte, Metall Glas
Pendant lamp, metal glass

↔ Ø 500 mm ↑ 2000 mm

Excl. 1x E27

317690132 | Schwarz matt, Chrom
bedampft | Black mat, Chrome plated



CIPALLONE

Deckenleuchte, Metall Glas
Ceiling lamp, metal glass

↔ Ø 300 mm ↑ 360 mm

Excl. 1x E27

617600132 | Schwarz matt, Chrom
bedampft | Black mat, Chrome plated



CIPALLONE

KLASSISCHE ÄSTHETIK
CLASSIC AESTHETICS

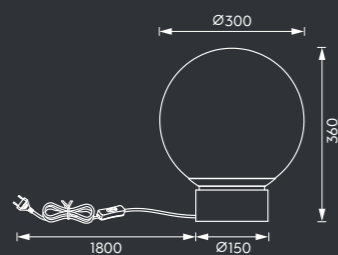
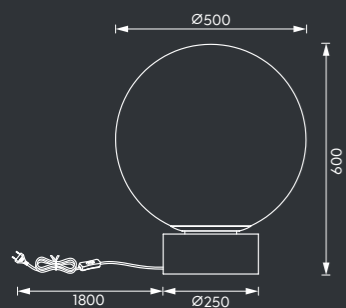

CIPALLONE

Tischeuchte, Metall Glas
Table lamp, metal glass

↔ Ø 500 mm ↑ 600 mm

Excl. 1x E27

517690132 | Schwarz matt, Chrom
bedampft | Black mat, Chrome plated



CIPALLONE

Tischeuchte, Metall Glas
Table lamp, metal glass

↔ Ø 300 mm ↑ 360 mm

Excl. 1x E27

517600132 | Schwarz matt, Chrom
bedampft | Black mat, Chrome plated



CIPERA

MODERN UND STILVOLL
STATE-OF-THE-ART AND STYLISH



Die Pendelleuchten CIPERA vereinen modernste Lichttechnik mit stilvollem Glasdesign. Blendfreies homogenes LED-Licht, spielerisch eingefangen in kunstvollem Glas, verleiht den Leuchten einen einzigartigen Charakter und lässt sie garantiert zum Blickfang jeder Wohnraumgestaltung werden. Zur Wahl stehen verschiedene Ausführungen in den Kombinationen Weiß mit transparentem Glas und Schwarz mit effektvollem Spiegelglas.

The CIPERA pendant luminaires combine state-of-the-art lighting technology with stylish glass design. Glare-free homogeneous LED light, playfully captured in artistic glass, gives the luminaires a unique character and is guaranteed to make them the eye-catcher of any living room design. There is a choice of different versions in the combinations white with transparent glass and black with effective mirror glass.



CIPERA

MODERN UND STILVOLL
STATE-OF-THE-ART AND STYLISH



CI-MOTE
ready

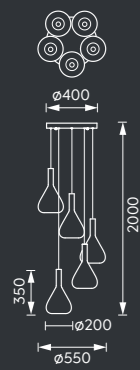

CIPERA

Pendelleuchte, Metall Glas
Pendant lamp, metal glass

↔ Ø 550 mm ↑ 2000 mm

SMD-LED, 5 x 5,6 W, 5 x 620 lm

2.000 - 4.000 K

345030531 | Weiß matt, transparent
White mat, transparent

345030532 | Schwarz matt, Chrom
bedampft · Black mat, Chrome plated



CIPERA

MODERN UND STILVOLL
STATE-OF-THE-ART AND STYLISH



CI-MOTE
ready

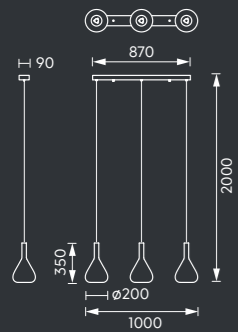
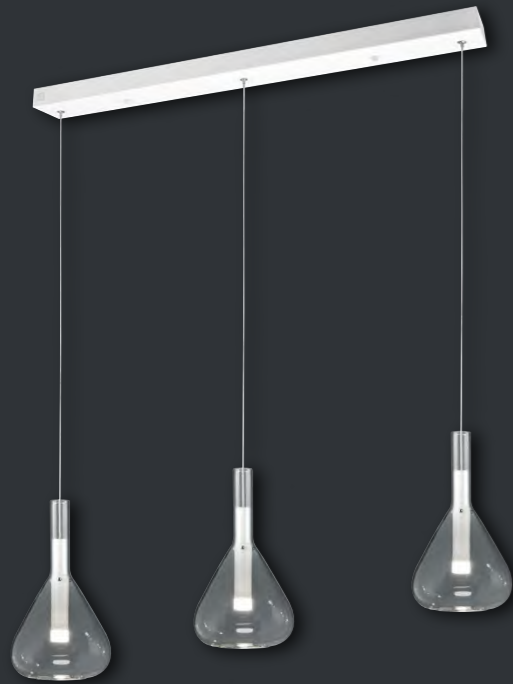

CIPERA

Pendelleuchte, Metall Glas
Pendant lamp, metal glass

↔ 1000 mm ↓ 2000 mm ↗ 200 mm

SMD-LED, 3 x 5,6 W, 3 x 620 lm

2.000 - 4.000 K

345010331 | Weiß matt, transparent
White mat, transparent

345010332 | Schwarz matt, Chrom
bedampft · Black mat, Chrome plated



CIPERA

MODERN UND STILVOLL
STATE-OF-THE-ART AND STYLISH



CI-MOTE
ready

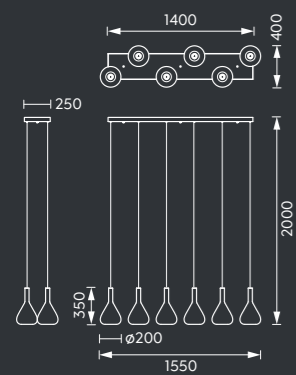

CIPERA

Pendelleuchte, Metall Glas,
Pendant lamp, metal glass

↔ 1550 mm ↑ 2000 mm ↗ 400 mm

SMD-LED, 6 x 5,6 W, 6 x 620 lm

2.000 - 4.000 K

345010631 | Weiß matt, transparent
White mat, transparent

345010632 | Schwarz matt, Chrom
bedampft · Black mat, Chrome plated



CILIANA

SCHLICHTE ELEGANZ
SIMPLE ELEGANCE



Schlichte Eleganz gehüllt in feines Leder. Das faszinierende Zusammenspiel aus Metall und Echtleder vereint Nüchternheit mit dem Besonderen. Die kugelförmigen Metallschirme sorgen für blendfreies, nach unten gerichtetes Licht. So finden die Leuchten ihren Platz idealerweise über Couch- oder Esstischen. Erhältlich sind die Pendelleuchten jeweils in edlem Nickel matt und coolem Schwarz.

Simple elegance wrapped in fine leather. The fascinating interplay of metal and genuine leather combines sobriety with something special. The spherical metal shades provide glare-free light directed downwards. Thus, the luminaires are ideally placed above couches or dining tables. The pendant lamps are available in elegant matt nickel and cool black.

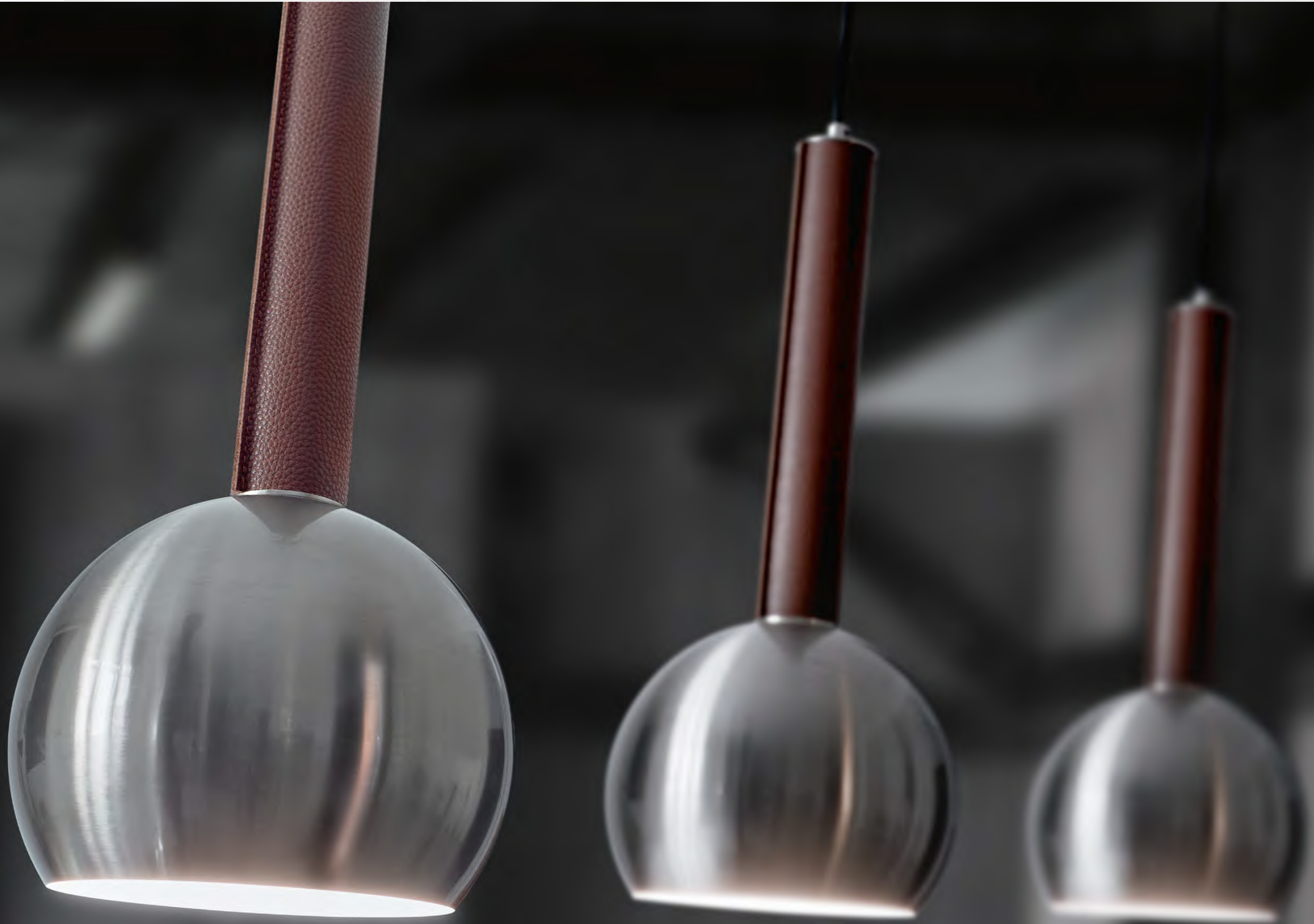

CILIANA

SCHLICHTE ELEGANZ
SIMPLE ELEGANCE

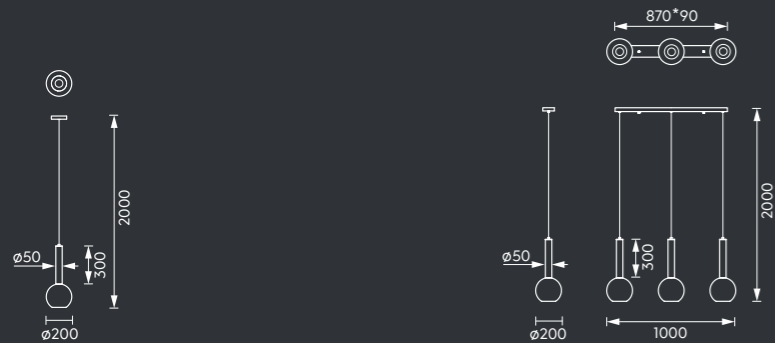

CILIANA

Pendelleuchte, Metall Leder
Pendant lamp, metal leather
↔ Ø 200 mm ↓ 2000 mm
excl. 1 x E27

316300107 | Nickel matt, Braun
Nickel mat, brown

316300132 | Schwarz matt, Schwarz
Black mat, black



CILIANA

Pendelleuchte, Metall Leder
Pendant lamp, metal leather
↔ 1000 mm ↓ 2000 mm ↗ 200 mm
excl. 3 x E27

316300307 | Nickel matt, Braun
Nickel mat, brown

316300332 | Schwarz matt, Schwarz
Black mat, black



CILIANA

SCHLICHTE ELEGANZ
SIMPLE ELEGANCE

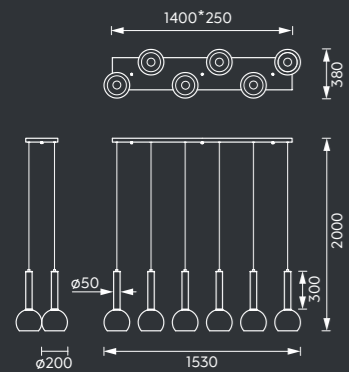

CILIANA

Pendelleuchte, Metall Leder
Pendant lamp, metal leather

↔ 1530 mm ↓ 2000 mm ↗ 380 mm

excl. 6 x E27

316300607 | Nickel matt, Braun
Nickel mat, brown

316300632 | Schwarz matt, Schwarz
Black mat, black



CILIANA

SCHLICHTE ELEGANZ
SIMPLE ELEGANCE

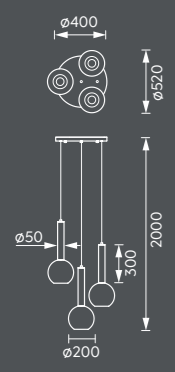
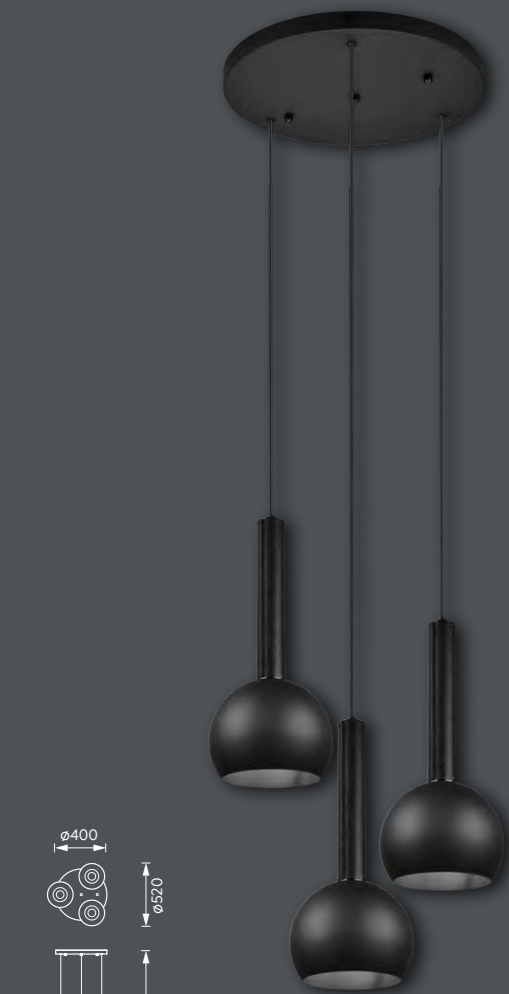

CILIANA
Pendelleuchte, Metall Leder
Pendant lamp, metal leather
↔ Ø 520 mm ↑ 2000 mm
excl. 3 x E27

316330307 | Nickel matt, Braun
Nickel mat, brown

316330332 | Schwarz matt, Schwarz
Black mat, black



DIM-TO-WARM

IMMER DIE RICHTIGE STIMMUNG
ALWAYS THE RIGHT MOOD



4.000 K - NEUTRALWEISS | NEUTRAL WHITE

Gute Lichtqualität definiert sich unter anderem durch die Lichtfarbe. Der Begriff „Kelvin“ beschreibt die Lichtfarbe. Je höher dieser Wert ist, desto neutraler bzw. kälter ist das Licht. Unterschiedliche Bedürfnisse verlangen nach individuellen Lichtstimmungen. Für ein Höchstmaß an Wohlbefinden, sind alle Leuchten der Marke CINQUE mit der innovativen Dim-to-Warm Technologie ausgestattet. Gegenüber der herkömmlichen Dimmfunktion, reduziert sich beim Dimmen nicht nur die Lichtstärke, sondern auch die Lichtfarbe. Je weiter die Helligkeit reduziert wird, desto wärmer wird auch das Licht. Für ein helles weißes Licht starten Sie mit 4.000 Kelvin Farbtemperatur. Wünschen Sie eine besonders warme Atmosphäre, dimmen Sie die Farbtemperatur auf 2.000 Kelvin herab – und dies alles stufenlos und absolut flackerfrei.

Good light quality is defined, amongst other things, by the colour of the lighting. The term “Kelvin” describes the colour of the lighting. The higher this value, the more neutral or cold the lighting is. Different needs call for individual lighting moods. For maximum physical comfort all CINQUE brand lamps are equipped with the innovative “DIM TO WARM” technology. In contrast to conventional dimming functions, with CINQUE technology it is not just the light intensity that is reduced, but also the colour of the lighting. The more the brightness is reduced, the warmer the light also becomes. For a bright white light, start with a colour temperature of 4000 Kelvin. If you want a particularly warm atmosphere, you can dim the colour temperature down to 2000 Kelvin – and all of this can be done progressively and absolutely flicker-free.

3.000 K - WARMWEISS | WARM WHITE



2.000 K - WARM | WARM



DIM-TO-WARM

FR NL ES IT



DIM-TO-WARM pour une ambiance chaleureuse !

Une bonne qualité de lumière est entre autres déterminée par la couleur de l'éclairage. Le terme "Kelvin" décrit la couleur de l'éclairage. Plus cette valeur est élevée, plus l'éclairage est neutre, ou froid. Des besoins différents appellent des ambiances lumineuses différentes. Pour une convivialité maximale, toutes les lampes de la marque CINQUE sont équipées de la technologie innovante "DIM TO WARM". Contrairement aux fonctions de réglage de l'intensité classiques, avec la technologie CINQUE, ce n'est pas seulement l'intensité lumineuse qui varie, mais également la couleur de l'éclairage. Plus la luminosité est réduite, plus la lumière devient chaude. Pour une lumière blanche brillante, commencez avec une température de couleur de 4000 Kelvin. Si vous êtes à la recherche d'une atmosphère particulièrement chaleureuse, vous pouvez abaisser la température de couleur jusqu'à 2000 Kelvin – et tout cela de manière progressive et sans aucun scintillement.

DIM-TO-WARM voor een gezellige sfeer!

Een goede lichtkwaliteit wordt onder andere bepaald door de kleur van de verlichting. Met de term "kelvin" wordt de kleur van de verlichting beschreven. Hoe hoger deze waarde, des te neutraler of kouder is de verlichting. Verschillende behoeften vereisen individuele verlichtingsstemmingen. Voor maximaal fysiek comfort zijn alle lampen van het merk CINQUE uitgerust met de innovatieve "DIM TO WARM"-technologie. In tegenstelling tot de klassieke dimfuncties wordt met CINQUE-technologie niet alleen de lichtintensiteit verminderd, maar ook de kleur van het licht. Hoe meer de felheid wordt verminderd, des te warmer wordt het licht. Voor een fel wit licht begint u met een kleurtemperatuur van 4000 kelvin. Als u een bijzonder warme sfeer wilt, kunt u de kleurtemperatuur dimmen tot 2000 kelvin. Dit kan allemaal geleidelijk gedaan worden en absoluut zonder flikkeren.

DIM TO WARM para un entorno acogedor.

Una iluminación de buena calidad se define, entre otras cosas, por su color. El término «Kelvin» describe el color de la iluminación. Cuanto más alto sea este valor, más neutra o fría será la iluminación. Diferentes necesidades requieren ambientes de iluminación individuales. Todas las lámparas de la marca CINQUE están equipadas con la innovadora tecnología «DIM TO WARM» para ofrecer el máximo confort. A diferencia de las funciones de atenuación convencionales, la tecnología de las lámparas CINQUE no solo reduce la intensidad de iluminación, sino también su color. Cuanto más se reduce el brillo, más cálida es la luz. Para obtener una luz blanca brillante, empiece por una temperatura del color de 4000 Kelvin. Si desea conseguir un entorno particularmente cálido, puede atenuar la temperatura del color a 2000 Kelvin; ¡y lo mejor es que puede hacerlo de forma progresiva y sin parpadeos!

DIM-TO-WARM per un'atmosfera accogliente!

La buona qualità dell'illuminazione è determinata, tra l'altro, dal suo colore. Il termine "Kelvin" descrive il colore dell'illuminazione. Più questo valore è alto e più l'illuminazione risulta neutra o fredda. Le diverse esigenze richiedono stati d'animo personali in termini di illuminazione. Per il massimo comfort fisico, tutte le lampade del marchio CINQUE sono dotate dell'innovativa tecnologia "DIM TO WARM". Diversamente dalle funzioni di dimmerazione convenzionali, la tecnologia CINQUE non permette solo di modificare l'intensità luminosa, ma anche il colore dell'illuminazione. Più la luminosità si riduce, più calda diventa la luce. Per una luce bianca luminosa, iniziare con una emperatura di colore di 4000 Kelvin. Se si desidera un'atmosfera particolarmente calda, si può abbassare la temperatura di colore fino a 2000 Kelvin – e tutto questo può essere fatto in modo progressivo e senza alcuno sfarfallio.



CI·MOTE

PERFEKTES LICHTERLEBNIS
PERFECT LIGHT EXPERIENCE

*Make it
Smarter*

CI·MOTE – für das perfekte Lichterlebnis

Schon durch die DIM TO WARM-Technik bieten CINQUE-Leuchten einen großen Bedienkomfort. Doch es geht noch komfortabler. Mit dem neuen CI·MOTE-Plugin-Modul wird die Lichtsteuerung nicht nur smart, sondern schlichtweg genial. Obendrein ist sie mühelos und schnell installiert.

Das vorhandene DIM TO WARM-Basismodul einfach durch das CI·MOTE-Plugin-Modul ersetzen, und schon lässt sich die Beleuchtung individuellen Vorlieben und Bedürfnissen anpassen. Damit bietet CI·MOTE für jede Raumsituation das perfekte Lichterlebnis.

CI·MOTE – for the perfect light experience

CINQUE luminaires already offer great ease of use thanks to the DIM TO WARM technology. But it can be even more convenient. With the new CI·MOTE plug-in module, lighting control is not only smart, but simply ingenious. On top of that, it is installed effortlessly and quickly.

Simply replace the existing DIM TO WARM base module with the CI·MOTE plug-in module and the lighting can be adapted to individual preferences and needs. CI·MOTE thus offers the perfect lighting experience for every room situation.



cinque.lighting/
ci-mote



SIMPLE TO SET THE RIGHT AMBIENCE



Make it Smarter

- Steuerung der Leuchten mittels Fernbedienung oder mit der WiZ-App von überall per Smartphone oder Tablet (www.wizconnected.com)
- Helligkeit und Lichtfarbe getrennt voneinander stufenlos regelbar
- Einstellung und Programmierung individueller Lichtszenarien mit Memory-Funktion
- Steuerung über Zeitpläne oder einfache Sprachbefehle. Kompatibel mit allen gängigen Sprachassistenten wie Amazon Alexa, Google Home oder Siri

- Control of the luminaires by remote control and via the WiZ app
- Brightness and light colour separately, infinitely adjustable
- Setting and programming of individual light scenarios with memory function.
- Control via time schedules or voice commands. Compatible with all common voice assistants (Amazon Alexa, Google Home or Siri)

CI·MOTE

WiZ Funk-Fernbedienung, Metall
WiZ Remote control, metal

↔ 83 mm ↑ 103 mm ↗ 12 mm

Akku 3,7 V, 1.000 mAh

FB071-01 | Schwarz matt · Black mat

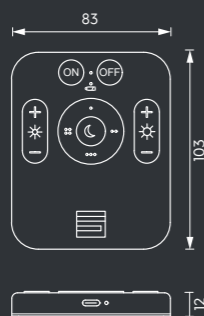

VERBUNDEN MIT DER WIZ-APP CONNECTED BY WIZ

Connected by
WIZ



FERNBEDIENUNG REMOTE CONTROL

- | | |
|---|---|
| → Stufenloses Dimmen | → Stepless dimming |
| → Lichtfarbe stufenlos einstellbar (2.000 - 4.500 Kelvin) | → Light colour continuously adjustable (2,000 - 4,500 Kelvin) |
| → 4 verschiedene Lichtszenen auf Knopfdruck | → 4 different light scenes at the touch of a button |
| → Nachlichtfunktion | → Night light function |
| → USB-C-Ladeanschluss | |



STEUERUNG NACH WUNSCH CONTROL AS YOU LIKE



Steuerung von überall
Control anywhere



Zeitpläne
Schedules



Sprachbefehle
Voice control



Fernbedienung
Remote control

works with
Siri Shortcuts

works with
alexa

works with
Google Home

LIEFERUMFANG CONTENT

- | | |
|---|---|
| → CI·MOTE-Plugin-Modul | → CI·MOTE plug-in module |
| → Elegante Fernbedienung mit USB-C-Ladefunktion | → Elegant remote control with USB-C charging function |
| → Praktische Magnet-Wandhalterung | → Practical magnetic wall mount |
| → USB-C Ladekabel | → USB-C charging cable |



IMMER DIE RICHTIGE STIMMUNG ALWAYS THE RIGHT MOOD

DIMMEN | DIMMING



64.000 WEISSTÖNE
64,000 WHITES

Einstellbare Lichtprogramme
Preset light modes



AMBIENTE EINFACH EINZUSTELLEN SIMPLE TO SET THE RIGHT AMBIENCE

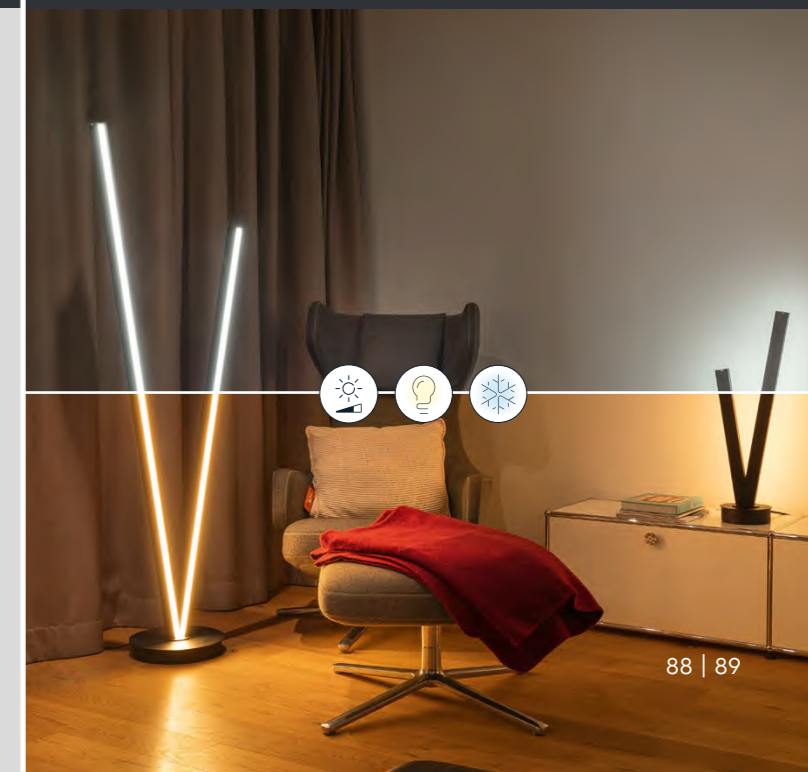

*Make it
Smarter*

(FR)

CI·MOTE – pour l'expérience lumineuse parfaite

Les luminaires CINQUE offrent déjà une grande facilité d'utilisation grâce à la technologie DIM TO WARM. Mais ils peuvent être encore plus pratiques. Avec le nouveau module enfichable CI·MOTE, le contrôle de l'éclairage n'est pas seulement intelligent mais simplement ingénieux. En outre, ils s'installent sans effort et rapidement. Remplacez simplement le module de base DIM TO WARM par l'unité de contrôle CI·MOTE et l'éclairage peut s'adapter aux préférences et besoins individuels. CI·MOTE offre donc l'expérience lumineuse parfaite pour chaque pièce.

- Contrôle des luminaires par télécommande et via WiZ-app
- Luminosité et couleur des lumières réglables séparément et à l'infini
- Configuration et programmation des ambiances lumineuses individuelles avec fonction mémoire.
- Contrôle selon les heures ou par commande vocale. Compatible avec tous les assistants vocaux courants (Amazon Alexa, Google Home or Siri)

Télécommande

- Variation du flux lumineux
- Couleur des lumières continuellement réglable (2 000 - 4 500 Kelvin)
- 4 ambiances lumineuses différentes en touchant un bouton
- Fonction éclairage nocturne

Contenu

- Module de contrôle enfichable CI·MOTE
- Télécommande élégante avec fonction de charge USB-C
- Montage mural aimanté pratique

(NL)

CI·MOTE – voor de perfecte lichtervaring

CINQUE-verlichtingstoestellen bieden reeds groot gebruiksgemak dankzij de DIM TO WARM-technologie. Maar het kan zelfs nog handiger zijn. Met de nieuwe CI·MOTE plug-in module is verlichtingsregeling niet enkel smart, maar eenvoudigweg ingenieus. Bovendien wordt het moeiteloos en snel geïnstalleerd. Vervang eenvoudigweg de huidige DIM TO WARM-basismodule met de CI·MOTE-besturingseenheid en de verlichting kan aangepast worden aan individuele voorkeuren en noden. CI·MOTE biedt dus de perfecte verlichtingservaring voor elke kamersituatie.

- Regeling van de verlichtingstoestellen met afstandsbediening en via de WiZ-app
- Helderheid en lichtkleur apart, oneindig aanpasbaar
- Instelling en programmering van individuele lichtscenario's met geheugenfunctie.
- Regeling via tijdschema's of spraakopdrachten. Compatibel met alle gebruikelijke spraakassistenten (Amazon Alexa, Google Home or Siri)

Afstandsbediening

- Staploos dimmen
- Lichtkleur voortdurend aanpasbaar (2.000 - 4.500 Kelvin)
- 4 verschillende lichtscènes bij aanraking van een toets
- Nachtlichtfunctie

Inhoud

- CI·MOTE plug-in regelingsmodule
- Elegante afstandsbediening met USB-C laadfunctie
- Praktische magnetische muurmontage

(ES)

CI·MOTE: la experiencia de iluminación perfecta

Las lámparas CINQUE ofrecen un uso de gran sencillez gracias a la tecnología DIM TO WARM. No obstante, pueden brindar aún más comodidad con el nuevo módulo enchufable CI·MOTE; este brinda un control de la iluminación inteligente y sencillamente ingenioso. Además, su instalación es rápida y sin esfuerzos. Solo es necesario sustituir el módulo base DIM TO WARM con la unidad de control del CI·MOTE para poder adaptar la iluminación a sus preferencias y necesidades personales. CI·MOTE brinda la experiencia de iluminación perfecta a la estancia para cada situación.

- Control de las lámparas por control remoto a través de la WiZ-app
- Control independiente del brillo y color de la iluminación, totalmente graduable
- Configuración y programación de entornos de iluminación individuales con función memoria.
- Control mediante programación de horarios y comandos por voz. Compatible con todos los asistentes controlados por voz habituales (Alexa de Amazon, Google Home or Siri)

Control remoto

- Atenuación gradual de la luz
- Color de la luz ajustable ininterrumpidamente (2.000 - 4.500 Kelvin)
- 4 escenas de iluminación distintas con solo pulsar un botón
- Función de iluminación nocturna

Contiene

- Módulo de control enchufable CI·MOTE
- Mando a distancia elegante con función de carga mediante USB-C
- Práctico soporte de pared magnético

(IT)

CI·MOTE – per l'esperienza di illuminazione perfetta

Gli apparecchi CINQUE offrono già una grande facilità d'uso grazie alla tecnologia DIM TO WARM. Ma può essere ancora più comodo. Con il nuovo modulo plug-in CI·MOTE, il controllo della luce non è solo intelligente, ma semplicemente geniale. Inoltre, si installa in modo semplice e veloce. È sufficiente sostituire il modulo base DIM TO WARM esistente con l'unità di controllo CI·MOTE per adattare l'illuminazione alle preferenze e alle esigenze individuali. CI·MOTE offre così un'esperienza di illuminazione perfetta per ogni situazione ambientale.

- Controllo degli apparecchi tramite telecomando e tramite WiZ-app
- Luminosità e colore della luce separati, regolabili in infiniti modi
- Impostazione e programmazione di scenari luminosi individuali con funzione di memoria.
- Controllo tramite programmi orari o comandi vocali. Compatibile con tutti i più comuni assistenti vocali (Amazon Alexa, Google Home or Siri)

Telecomando

- Dimmerazione graduale
- Colore della luce regolabile in continuo (2000 - G14 Kelvin)
- 4 diverse scene di luce con la semplice pressione di un pulsante
- Funzione luce notturna

Contenuto

- Modulo di controllo plug-in CI·MOTE plug-in control module
- Elegante telecomando con funzione di ricarica USB-C
- Pratico supporto magnetico per installazione a parete



cinque.lighting/
ci-mote

INDEX

Art-Nr.	EAN	Familie Family	Serie Series	Farbe Colour	CI-MOTE ready	Seite Page
245410131	4017807579482	Wand- und Deckenleuchte Wall and ceiling lamp	CIFAVO	○	CI-MOTE ready	8
245410132	4017807579475	Wand- und Deckenleuchte Wall and ceiling lamp	CIFAVO	●	CI-MOTE ready	8
245490131	4017807579468	Wand- und Deckenleuchte Wall and ceiling lamp	CIFAVO	○	CI-MOTE ready	10
245490132	4017807579451	Wand- und Deckenleuchte Wall and ceiling lamp	CIFAVO	●	CI-MOTE ready	10
444610131	4017807578393	Stehleuchte Floor lamp	CIZIONE	○	CI-MOTE ready	14
444610132	4017807578423	Stehleuchte Floor lamp	CIZIONE	●	CI-MOTE ready	14
544610131	4017807578379	Tischleuchte Table lamp	CIZIONE	○	CI-MOTE ready	16
544610132	4017807578409	Tischleuchte Table lamp	CIZIONE	●	CI-MOTE ready	16
544690131	4017807578386	Tischleuchte Table lamp	CIZIONE	○	CI-MOTE ready	16
544690132	4017807578416	Tischleuchte Table lamp	CIZIONE	●	CI-MOTE ready	16
245110207	4017807579215	Wandleuchte Wall lamp	CICARA	○	CI-MOTE ready	24
245190207	4017807579222	Wandleuchte Wall lamp	CICARA	●	CI-MOTE ready	24
345110207	4017807579185	Pendelleuchte Pendant lamp	CICARA	○	CI-MOTE ready	20
445110207	4017807579192	Stehleuchte Floor lamp	CICARA	●	CI-MOTE ready	22
545110207	4017807579208	Tischleuchte Table lamp	CICARA	○	CI-MOTE ready	22
346110107	4017807579505	Pendelleuchte Pendant lamp	CINARDI	○	CI-MOTE ready	28
346110132	4017807579499	Pendelleuchte Pendant lamp	CINARDI	●	CI-MOTE ready	28
446110107	4017807579536	Stehleuchte Floor lamp	CINARDI	○	CI-MOTE ready	30
446110132	4017807579512	Stehleuchte Floor lamp	CINARDI	●	CI-MOTE ready	30
546110107	4017807579567	Tischleuchte Table lamp	CINARDI	○	CI-MOTE ready	30
546110132	4017807579550	Tischleuchte Table lamp	CINARDI	●	CI-MOTE ready	30
377210107	4017807471717	Pendelleuchte Pendant lamp	CIOLA	○	CI-MOTE ready	34
377210132	4017807471755	Pendelleuchte Pendant lamp	CIOLA	●	CI-MOTE ready	34
477210107	4017807471649	Stehleuchte Floor lamp	CIOLA	○	CI-MOTE ready	38
477210132	4017807471687	Stehleuchte Floor lamp	CIOLA	●	CI-MOTE ready	38
577210107	4017807471601	Tischleuchte Table lamp	CIOLA	○	CI-MOTE ready	38
577210132	4017807471632	Tischleuchte Table lamp	CIOLA	●	CI-MOTE ready	38
677210107	4017807471786	Deckenleuchte Ceiling lamp	CIOLA	○	CI-MOTE ready	36
677210132	4017807471779	Deckenleuchte Ceiling lamp	CIOLA	●	CI-MOTE ready	36
375010107	4017807543100	Pendelleuchte Pendant lamp	CICANTO	○	CI-MOTE ready	42
375010132	4017807543094	Pendelleuchte Pendant lamp	CICANTO	●	CI-MOTE ready	42
475010107	4017807543285	Stehleuchte Floor lamp	CICANTO	○	CI-MOTE ready	46
475010132	4017807543278	Stehleuchte Floor lamp	CICANTO	●	CI-MOTE ready	46
575010107	4017807543339	Tischleuchte Table lamp	CICANTO	○	CI-MOTE ready	46
575010132	4017807543315	Tischleuchte Table lamp	CICANTO	●	CI-MOTE ready	46
675010107	4017807543131	Wand- und Deckenleuchte Wall and ceiling lamp	CICANTO	○	CI-MOTE ready	44
675010132	4017807543124	Wand- und Deckenleuchte Wall and ceiling lamp	CICANTO	●	CI-MOTE ready	44
378510232	4017807471878	Pendelleuchte Pendant lamp	CIZENZA	●	-	50
478510132	4017807471854	Stehleuchte Floor lamp	CIZENZA	●	CI-MOTE ready	52
578510132	4017807471830	Tischleuchte Table lamp	CIZENZA	●	CI-MOTE ready	52
373510932	4017807471496	Pendelleuchte Pendant lamp	CIVETO	○	CI-MOTE ready	58
373511232	4017807471526	Pendelleuchte Pendant lamp	CIVETO	●	CI-MOTE ready	56
673512032	4017807471540	Deckenleuchte Ceiling lamp	CIVETO	○	CI-MOTE ready	56
317690132	4017807579352	Pendelleuchte Pendant lamp	CIPALLONE	●	-	62
517600132	4017807579390	Tischleuchte Table lamp	CIPALLONE	●	-	64
517690132	4017807579406	Tischleuchte Table lamp	CIPALLONE	●	-	64
617600132	4017807579383	Deckenleuchte Ceiling lamp	CIPALLONE	●	-	62
345010331	4017807555899	Pendelleuchte Pendant lamp	CIPERA	○	CI-MOTE ready	70
345010332	4017807555905	Pendelleuchte Pendant lamp	CIPERA	●	CI-MOTE ready	70
345010631	4017807542950	Pendelleuchte Pendant lamp	CIPERA	○	CI-MOTE ready	72
345010632	4017807542929	Pendelleuchte Pendant lamp	CIPERA	●	CI-MOTE ready	72
345030531	4017807542875	Pendelleuchte Pendant lamp	CIPERA	○	CI-MOTE ready	68
345030532	4017807542868	Pendelleuchte Pendant lamp	CIPERA	●	CI-MOTE ready	68
316300107	4017807552621	Pendelleuchte Pendant lamp	CILIANA	○	-	76
316300132	4017807552614	Pendelleuchte Pendant lamp	CILIANA	●	-	76
316300307	4017807552683	Pendelleuchte Pendant lamp	CILIANA	○	-	76
316300332	4017807552676	Pendelleuchte Pendant lamp	CILIANA	●	-	76
316300607	4017807552706	Pendelleuchte Pendant lamp	CILIANA	○	-	78
316300632	4017807552690	Pendelleuchte Pendant lamp	CILIANA	●	-	78
316330307	4017807552669	Pendelleuchte Pendant lamp	CILIANA	○	-	80
316330332	4017807552652	Pendelleuchte Pendant lamp	CILIANA	●	-	80
FB071-01	4017807552881	Funk-Fernbedienung Remote control	CI-MOTE	●	-	88

FEATURES



Extern dimmbar | Externally dimmable | Dimmable avec variateur externe | Extern dimbaar | Dimmable por regulador externo | Dimmerabile con dimmer esterno



DIM TO WARM: Stufenlose Einstellung der Lichtfarbe beim Dimmen (von Kaltweiß zu Warmweiß) | Variable setting of the light color when dimming (from cold white to warm white) | Réglage en continu de la couleur de la lumière avec un variateur (du blanc froid au blanc chaud) | Niveauloze instelling van de lichtkleur bij het dimmen (van koud wit naar warm wit) | Regulación continua del color de la luz mediante atenuador (de frío a cálido) | Regolazione continua della luce durante la gradazione (da bianco freddo a bianco caldo)



Lichtfarbe stufenlos einstellbar | Light color infinitely variable | Couleur de lumière infiniment variable | Lichtkleur traploos instelbaar | Color de luz infinitamente variable | Colore della luce infinitamente variabile



Integrierter Dimmer | Integrated dimmer | Variateur intégré | Geïntegreerde dimmer | Regulador integrado | Dimmer integrato



Fußschalter | Footswitch | Interrupteur à pédale | Voetschakelaar | Interruptor de pie | Interruttore a pedale



Ohne Leuchtmittel | Lamp(s) excluded | Sans ampoule(s) | Zonder lichtbron(nen) | Sin bombilla(s) | Lampadina Esclusa



Up and down Beleuchtung | Up and Down lighting | Point lumineux en haut et en bas | Lichtpunt boven en onder | Luz de arriba y abajo | Luce su e giù



Höhenverstellbar | Adjustable height | Hauteur réglable | In hoogte verstelbaar | Altura regulable | Altezza regolabile



Schalter | Switch | Interrupteur | Schakelaar | Interruptor | Interruttore



Nachlicht | Night light | Veilleuse de nuit | Nachtlamp | Luz de la noche | Luce notturna



Helligkeit einstellbar | Adjustable light level | Niveau d'éclairage ajustable | Instelbaar lichtniveau | Nivel de luz ajustable | Livello di luce regolabile



Akkubetrieb | Rechargeable battery operated | Fonctionnement sur batteries rechargeable | Werkt op oplaadbare batterijen | Bateria recargable | Batteria Ricaricabile



WiZ Connected



Echtes Leder | Genuine leather | Cuir véritable | Echt leer | Piel genuina | Vera pelle



Diese Leuchte ist CI-MOTE kompatibel | This luminaire is CI-MOTE compatible | Ce luminaire est compatible CI-MOTE | Dit verlichtingstoestel is CI-MOTE compatibel | Esta luminaria es compatible con CI-MOTE | Questo apparecchio è compatibile CI-MOTE

TRIO Leuchten GmbH

Gut Nierhof 17
D-59757 Arnsberg
T +49 2931 9666-0
F +49 2931 9666-28

info@trio-leuchten.de
www.trio-leuchten.de

DEUTSCHLAND

BADEN WÜRTTEMBERG,
RHEINLAND-PFALZ,
SAARLAND

Antonio De Simone
T +49 (0) 151 58555222
antonio.desimone@trio-leuchten.de

BAYERN, HESSEN

Martin Kluge
T +49 (0) 171 7300330
martin.kluge@trio-leuchten.de

BERLIN, BRANDENBURG,
MECKLENBURG-
VORPOMMERN, SACHSEN,
SACHSEN-ANHALT,
THÜRINGEN

Jörg Bumke
T +49 (0) 160 7406860
joerg.bumke@trio-leuchten.de

BREMEN, HAMBURG,
NIEDERSACHSEN,
SCHLESWIG-HOLSTEIN

Jens Gebers
T +49 (0) 170 1615227
jens.gebers@trio-leuchten.de

NORDRHEIN-WESTFALEN

Christian Teller
T +49 (0) 171 4521820
christian.teller@trio-leuchten.de

ÖSTERREICH

Wolfgang Melich
T +43 (0) 6605161228
wolfgang.melich@trio-leuchten.de

SCHWEIZ

TRIO Leuchten
T +49 (0) 2931 9666-0
info@trio-leuchten.de

TRIO International GmbH

Gut Nierhof 17
D-59757 Arnsberg
T +49 2931 9666-587
F +49 2931 9666-56

info@trio-lighting.com
www.trio-lighting.com

FRANCE

Stéphane Papierny
Directeur Commercial France
info.france@trio-lighting.com

Julien Lamouret
Product Manager France &
Sales Manager DIY France
info.france@trio-lighting.com

Jean Philippe Bailly
info.france@trio-lighting.com
*Agent exclusif pour les départements
60, 75 Nord, 92, 93 et 95*

Jean Barel
info.france@trio-lighting.com
*Agent exclusif pour les départements
09, 12, 15, 16, 19, 24, 31, 32, 33, 40, 46,
47, 64, 65, 81, 82 et 87*

Jean Marc Beneforti
info.france@trio-lighting.com
*Agent exclusif pour les départements
2a et 2b*

Christophe Meulien
info.france@trio-lighting.com
*Agent exclusif pour les départements
04, 05, 06, 11, 13, 30, 34, 66, 83 et 84*

Sullivan Nicolas
info.france@trio-lighting.com
*Commercial pour les départements
01, 03, 07, 21, 23, 26, 38, 39, 42, 43, 48,
63, 69, 71, 73 et 74*

Stéphane Riebel
info.france@trio-lighting.com
*Agent exclusif pour les départements
18, 27, 28, 45, 58, 75 Sud, 76, 77,
78, 89, 91 et 94*

Michel Salamand
info.france@trio-lighting.com
*Agent exclusif pour les départements
14, 17, 22, 29, 35, 36, 37, 41, 44, 49, 50,
53, 56, 61, 72, 79, 85 et 86*

Vincent Zaepffel
info.france@trio-lighting.com
*Commercial pour les départements
02, 08, 10, 25, 51, 52, 54, 55, 57, 59, 62,
67, 68, 70, 80, 88 et 90*

DANMARK

Jan Rantzau-Bartens
info.denmark@trio-lighting.com

NORDIC & BALTIC

TRIO Lighting Scandinavia Oy
Malmin raitti, rappu 17 B
00700 Helsinki
T +358 (0) 10 23 13 390
tls@trio-lighting.com
*Our Scandinavian organisation represents
TRIO also in Sweden, Norway, Estonia, Latvia,
Lithuania and Iceland*

ITALIA

TRIO Lighting Italia s.r.l
Via Isonzo 81
22066 Mariano Comense (CO)
commerciale@trio-lighting.com



cinque.lighting

ESPAÑA

TRIO Lighting Ibèrica SL
C/ Can Lietget nº9 nave 9
Pol. Ind. Can Roqueta
08206 Sabadell
T +34 (0) 9 35 45 86 30
F +34 (0) 9 33 96 45 48
info.iberica@trio-lighting.com

GREAT BRITAIN

TRIO Lighting UK Ltd.
Unit 5, Hemmells Park Hemmells,
Laindon Essex
SS1s 6GF
T +44 (0) 12 68 88 95 95
F +44 (0) 12 68 88 95 96
sales@trio-lightinguk.com

NEDERLAND

Karl Stok / Bas Martin
info.nederland@trio-lighting.com

BELGIUM / BELGIQUE

Yves Van den Berghe
info.belgium@trio-lighting.com

ROMANIA

Loredana Barbu
info.romania@trio-lighting.com
loredana.barbu@trio-lighting.com



