



TRIO Leuchten GmbH

Gut Nierhof 17
D-59757 Arnsberg
T +49 (0) 2931 9666-0
F +49 (0) 2931 9666-28
info@trio-leuchten.de
www.trio-leuchten.de

TRIO International GmbH

Gut Nierhof 17
D-59757 Arnsberg
T +49 (0) 2931 9666-587
F +49 (0) 2931 9666-56
info@trio-lighting.com
www.trio-lighting.com



LIGHTING FOR YOU



23 | 24



CATALOGUE
2023 / 2024



Intelligente Lichtsteuerung · smart lighting control 42 - 57
 contrôle d'éclairage intelligent · slimme lichtregeling · control de iluminación inteligente · controllo intelligente dell'illuminazione · control inteligent al iluminatului · älykäs valaistuksen ohjaus · Inteligentne sterowanie światłem



Leuchtenfamilien & Kombinationen · Families & coordinates 58 - 161
 Familles & coordonnés · Families & combinaties · Familias & coordinados · Famiglie & coordinati · Famillii & Coordinate · Tuotepiheet & yhdistettävät tuotteet · Rodzinne orawy & kombinacje

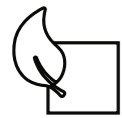

Natur & Design · Nature & Design 162- 213
 Nature et design · Natuur en design · Naturalidad & Diseño · Natura e design · Natură și design · Luonto ja suunnittelu · Naturalność i dizajn



Pendelleuchten & Kronen · Pendants & chandeliers 214- 261
 Lustres & suspensions · Hanglampen & kroonluchters · Colgantes y Lámparas · Lampadari e sospensioni · Lustre si pendule · Riippu- & kruunu · Wiszące i żyrandole



Wand- und Deckenleuchten · Wall & Ceiling lamps 262-375
 Applique & plafonniers · Wandlampen & plafonnières · Apliques y plafones · Applique e plafoniere · Plafoniere si aplices · Seinä- & katto · Sufitowe i ścienne

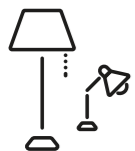

Steh- und Tischleuchten · Table- & floor lamps 376-449
 Lampes de table & lampadaires · Tafel- & vloerlampen · Sobremesas y lámparas de pie · Lampade da tavolo e piantane · Veioze si lampadare · Pöytä- & lattia · Stołowe i podłogowe



Spotserien · Spots 450 - 477
 Spotterie · Spots · Focos · Faretti · Spoturi · Spotit · Reflektorki



DUOline Schienensystem (230 V) · track system (230 V) 478-501
 Système de voie à deux phases (230 V) · 2-fase-spoorsysteem (230 V) · Sistema de rieles en 2 fases (230 V) · Sistema a binario bifase (230 V) · Sistem de piste cu 2 faze (230 V) · 2-vaihekiskojärjestelmä (230 V) · 2-fazowy system prowadnic (230 V)



Einbauleuchten · Recessed spots 502 - 515
 Spots encastrés · Inbouwspots · Focos empotrables · Faretti incasso · Spoturi incastrate · Upotetut spotit · Oprawy wbudowane



Badezimmerleuchten · Bathroom lighting 516- 551
 Éclairage salle de bains · Badkamer verlichting · Iluminación de cuarto de baño · Illuminazione per bagno · Iluminat baie · Kylpyhuone valaistus · Oświetlenie łazienkowe



Leuchtmittel · Light sources 552 - 563
 Ampoules · Lichtbronnen · Fuentes de luz · Lampadine · Becuri · Valonlähteet · Źródła światła



Spezifikationen · Specifications 574-587
 Spécifications · Specificaties · Especificaciones · Specifiche · Specificații · Tekniset tiedot · Specyfikacje



Kontakte · Contact 604 - 605
 Contact · Contact · Contactar · Contatto · Contact · Yhteydenotto · Kontakt

LIGHTING FOR YOU

DE

Liebe Kund*innen und Geschäftspartner*innen,
eine Wohnumgebung in der man sich wohlfühlt, ist ein Stück Lebensqualität!
Unsere neuesten Leuchten-Trends zeigen, wie Wohnbereiche individuell gestaltet und anspruchsvoll ausgeleuchtet werden können. Ob klassisch oder modern, warm und natürlich, puristisch oder glamourös – lassen Sie sich inspirieren!
Viel Vergnügen beim Durchstöbern unseres neuen Kataloges!

FR

Chers clients et partenaires commerciaux,
Un environnement de vie dans lequel vous vous sentez confortable est une pièce de qualité de vie !
Nous dernières tendances d'éclairage montrent comment les lieux de vie peuvent être individuellement conçus et élégamment éclairés. Qu'il soit classique ou moderne, chaleureux et naturel, puriste ou glamour - laissez-vous inspiré !
Enjoy browsing through our new catalogue!

GB

Dear customers and business partners,
A living environment in which you feel comfortable is a piece of quality of life!
Our latest lighting trends show how living areas can be individually designed and sophisticatedly illuminated. Whether classic or modern, warm and natural, purist or glamorous - let yourself be inspired!
Enjoy browsing through our new catalogue!

NL

Beste klanten en zakenpartners,
Een leefomgeving, waarin u zich comfortabel voelt, vormt een stukje levenskwaliteit!
Onze nieuwste verlichtingstrends tonen hoe leefruimtes individueel ontworpen en verfijnd verlicht kunnen worden. Of het nu klassiek of modern, warm en natuurlijk, purist of betoverend is - laat inspireren!
Geniet van grasduinen doorheen onze nieuwe catalogus!



ES

Queridos clientes y socios,
¡un ambiente en el que se sientan cómodos es parte vital de la calidad de vida!
Nuestras últimas tendencias en iluminación muestran como se pueden diseñar individualmente los ambientes e iluminarlos de forma sofisticada. Ya sea de forma clásica o moderna, cálida y natural, purista o glamorosa - ¡inspírate!
¡Disfruta de nuestro nuevo catálogo!

IT

Cari clienti e partner commerciali,
Un ambiente in cui ci si sente a proprio agio è un componente essenziale della qualità della vita!
Le nostre ultime tendenze in fatto di illuminazione mostrano come gli spazi abitativi possano essere progettati in modo personalizzato e illuminati in modo sofisticato. Classico o moderno, caldo e naturale, purista o glamour: lasciatevi ispirare!
Divertitevi a sfogliare il nostro nuovo catalogo!

RO

Dragi clienți și parteneri de afaceri,
Un mediu de viață în care vă simțiți confortabil este parte de calitatea vieții!
Ultimele noastre tendințe în iluminat arată cum zonele de locuit pot fi proiectate individual și iluminate sofisticat. Clasic sau modern, cald și natural, purist sau fastuos - lăsați-vă inspirați!
Bucurați-vă răsfoind noul nostru catalog!

FI

Hyvät asiakkaat ja yhteistyökumppanit.
Asuinympäristö, jossa tunnet olosi mukavaksi, on osa elämänlaatua! Viimeisin valaistustrendimme näyttää, kuinka olohuoneet voidaan suunnitella yksilöllisesti ja valaista hienostuneesti. Klassista tai modernia, lämmintä ja luonnollista, vähäeleistä tai yllleistä - anna itsesi inspiroitua!
Nauti uuteen kuvastoomme tutustumisesta!

PL

Szanowni Klienci i Partnerzy Handlowi,
Mieszkanie, w którym czujemy się komfortowo, to element jakości życia!
Nasze najnowsze trendy oświetleniowe pokazują, jak można indywidualnie projektować i oświetlać pomieszczenia mieszkalne. Klasyczne lub nowoczesne, ciepłe i naturalne, purystyczne lub efektowne - pozwólcie się zainspirować!
Zapraszamy do przeglądania naszego nowego katalogu!



Digital an Ihrer Seite.

Das digitale Erfolgselement
für moderne Kommunikation –
unser B2B-Portal myTRIO

Digitally at your side.

The Digital Success Element
for Modern Communication –
our myTRIO B2B Portal



Vorteile für registrierte Geschäftspartnerinnen und Geschäftspartner

Profitieren Sie von unserem schnellen und unkomplizierten Support! Mit nur einem Klick haben Sie Zugriff auf alle wichtigen Artikeldaten und können bequem Dateien herunterladen. Entdecken Sie diese Vorteile in unserem digitalen B2B-Portal myTRIO. Registrierte Nutzer finden dort alle relevanten Informationen zu unseren Produkten, von technischen Details bis hin zu Bildmaterial und Lagerbeständen. Sind Sie noch nicht registriert? Zögern Sie nicht, uns zu kontaktieren.

Advantages for Registered Business Partners

Benefit from our fast and uncomplicated support! With just one click you have access to all important item data and can conveniently download files. Discover these advantages in our myTRIO digital B2B portal. Registered users will find all relevant information about our products there, from technical details to images and the amount of products in stock. You are not registered yet? Do not hesitate to contact us.

my.trio-lighting.com

Besuchen Sie uns auch bequem von Zuhause aus!

Tauchen Sie in die virtuelle Welt ein und erkunden Sie unseren Ausstellungsraum mit unserer interaktiven 360° Tour. Egal ob auf dem PC, Tablet oder Smartphone, der Rundgang steht Ihnen direkt im Webbrowser zur Verfügung. Besonders beeindruckend wird die Präsentation, wenn Sie eine VR-Brille verwenden. Weitere Informationen finden Sie auf unserer Webseite. Schauen Sie gerne vorbei und genießen Sie das Erlebnis. Viel Spaß!

You Can Also Visit Us From the Comfort of Your Own Home!

Dive into the virtual world and explore our showroom with our interactive 360° tour. Whether on a PC, tablet or smartphone, the tour is available directly in your web browser. The presentation turns particularly impressive if you use VR glasses. You can find more information on our website. Feel free to stop by and enjoy the experience. Enjoy!



Funktioniert auch mit VR-Brillen
Also works with VR glasses

trio-lighting.com/showroom

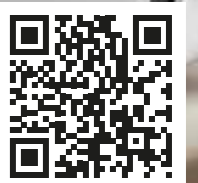

SERIENÜBERSICHT

Family overview · Aperçu par famille · Overzicht per familie · Vista general por familia ·
Panoramica per famiglia · Prezentare pe familii de produse · Perheen yleiskuvaus · Przegląd rodziny

| | | | | | | | | | | | | | | | |
|-----------|-----|------------|-----|----------|-----|----------|-----|----------|-----|----------|-----|-----------|-----|----------|-----|
| AARON | 48 | BOLSA | 518 | CURTIS | 430 | GRANADA | 270 | LEVISTO | 472 | MOTEL | 387 | RAMA | 168 | TAMIL | 150 |
| ADRIAN | 345 | BOOLAN | 213 | DAKOTA | 422 | GRANBY | 404 | LIÈGE | 393 | NAGANO | 329 | RAMON | 374 | TAURUS | 452 |
| ADRIANO | 351 | BRAD | 180 | DAVI II | 437 | GRANT | 225 | LIGARA | 370 | NALIDA | 56 | RAVEN | 346 | TEXEL | 392 |
| AGRA | 204 | BRANTFORD | 402 | DEACON | 175 | GRIFFIN | 54 | LILLY | 366 | NANDOR | 390 | RAY | 520 | THEATRO | 533 |
| AGUDO | 144 | BULLET | 294 | DELHI | 200 | GROOVY | 274 | LINE | 362 | NARCOS | 458 | RILA | 511 | THIAGO | 50 |
| AICK | 224 | BURTON | 130 | DIALLO | 154 | GUAYANA | 455 | LINO | 548 | NILAM | 193 | ROBIN | 108 | THOMPSON | 46 |
| AKITA | 305 | CAMDEN | 118 | DIAMO | 57 | HARPER | 164 | LIVIA | 249 | NIMBUS | 506 | ROCCO | 522 | TILL II | 436 |
| ALICIA | 104 | CAMILLA | 538 | DIEGO | 260 | HARRIS | 206 | LORELEY | 245 | NOLA | 429 | RODRIGO | 205 | TIRIAC | 298 |
| ALINO | 375 | CAMILLUS | 498 | DISCALGO | 98 | HEDDA | 184 | LORENA | 105 | NORIAKI | 331 | ROMA | 367 | TITUS | 322 |
| AMSTERDAM | 440 | CAMPO | 364 | DIVO | 364 | HELIOS | 217 | LORENZO | 550 | NURIA | 70 | ROMINO II | 244 | TOKYO | 327 |
| ANGELO | 536 | CANDELA | 240 | DOHA | 310 | HOSTEL | 136 | LOUIS | 348 | OAKLAND | 81 | RONDO | 86 | TOMMY | 500 |
| ANTIBES | 496 | CARRERA | 82 | DOLOMITE | 510 | HOTEL | 124 | LUCERNA | 243 | ONTARIO | 241 | ROPE | 212 | TOSH | 208 |
| APART | 540 | CASSIO | 382 | DONNA | 432 | HYDRA | 288 | LUGANO | 320 | ONYX | 254 | ROSS | 140 | TRACY | 381 |
| ARAGON | 372 | CAYA | 266 | DOWNEY | 284 | ICARO | 427 | LUGO | 268 | OSAKA | 324 | ROUBAIX | 492 | TRADITIO | 160 |
| ARGENTINA | 397 | CESAR | 333 | DURBAN | 229 | INDIRA | 300 | LUIS II | 438 | OXFORD | 299 | ROXIE | 147 | TRAJAN | 218 |
| ARGUS | 507 | CHARIVARI | 72 | ECCO | 371 | INGA | 186 | LUMINA | 102 | PAGO | 471 | RUNA | 188 | TRAY | 88 |
| ARINO | 352 | CHARLESTON | 283 | EDGE | 78 | IRVINE | 278 | LUNAR | 330 | PALI | 342 | RUSTICA | 156 | TUBULAR | 226 |
| ARIZONA | 410 | CHARLY | 56 | EDWARD | 423 | JASMIN | 256 | LUPO | 447 | PAMIR | 509 | SABIA | 384 | TUCSON | 281 |
| ARUNI | 176 | CHIRAZ | 247 | ELEMENT | 359 | JIMMY | 500 | LYON | 122 | PANEL | 498 | SALINAS | 76 | UMBERTO | 541 |
| ARVIN | 303 | CHIRON | 246 | ELISA | 114 | JIVE | 85 | MADISON | 94 | PAOLO | 542 | SAMURAI | 328 | VAPORE | 100 |
| ARY II | 436 | CHIROS | 355 | ELMAU | 194 | JOHANN | 341 | MADRAS | 210 | PAPER | 260 | SANDRINA | 116 | VARIO | 442 |
| ASCARI | 534 | CHRIS | 407 | EMERALD | 434 | JOOST II | 432 | MANSUR | 378 | PARIS II | 389 | SANNA | 253 | VENTURA | 433 |
| AURA | 504 | CINZIA | 539 | FABIO | 524 | JORDAN | 357 | MARIO | 358 | PAROS | 495 | SANTO II | 411 | VERONA | 413 |
| AVA | 441 | CLAAS | 388 | FERNANDO | 334 | JUDITH | 212 | MARLEY | 464 | PAVIA | 416 | SEASONS | 196 | VERUS | 323 |
| BALDO | 362 | CLAPTON | 456 | FILIGRAN | 421 | JULIETA | 142 | MARNIE | 60 | PEACOCK | 296 | SEDONA | 280 | VIA | 276 |
| BALE | 428 | CLARIMO | 547 | FILO | 250 | JURA | 514 | MARRIOT | 356 | PERRY | 445 | SEIKO | 326 | VIEW | 532 |
| BALINI | 106 | CLARK | 380 | FLETCHER | 251 | KAGAWA | 304 | MATS II | 438 | PHOENIX | 319 | SEQUENCE | 62 | VIOLA | 261 |
| BANGKOK | 398 | CLAYTON | 236 | FLEXO | 446 | KAZAN | 418 | MATTIMO | 528 | PIERA | 526 | SHANGHAI | 399 | VISTA | 52 |
| BARCA | 166 | CLEO | 354 | FRANCIS | 80 | KENAI | 512 | MEDERA | 170 | PIRIN | 510 | SHOGUN | 328 | WACO | 309 |
| BARON | 92 | COLINO | 190 | FRANKLIN | 66 | KERALA | 172 | MELA | 238 | PLANT | 211 | SIGNA | 117 | WALES | 350 |
| BARRIE | 406 | CONCHA | 347 | FREDDY | 426 | KHAN | 182 | MELBY | 53 | PLATON | 350 | SOLA | 396 | WANDA | 368 |
| BELFAST | 221 | COOKIE | 337 | FRODENO | 543 | KIMI | 444 | MERTON | 222 | POLO | 446 | SORRENTO | 282 | WINONA | 291 |
| BELL | 198 | CORD | 257 | FYNN II | 439 | KOLIAN | 530 | MICHAEL | 470 | PRIMO | 344 | SPIRELLI | 115 | XAVI | 544 |
| BELLARI | 174 | CORE | 505 | GALE | 286 | KORBA | 192 | MIGUEL | 348 | PRONTO | 448 | SPLIT | 409 | YAVA | 285 |
| BERGAMO | 412 | CORTEZ | 248 | GANADO | 290 | KULA | 521 | MIKO | 325 | PURA | 365 | STAMINA | 259 | ZAGROS | 508 |
| BERLIN | 435 | CRISTO | 434 | GARDA | 138 | LACAL | 220 | MINSK | 242 | PURE | 110 | STANLEY | 324 | ZANDOR | 90 |
| BISCUIT | 339 | CROSS | 152 | GIADA | 551 | LACAPO | 349 | MITA | 306 | QUEBEC | 401 | STEAM | 476 | ZAZOU | 366 |
| BLAZE | 74 | CRYSTEL | 293 | GIANNI | 535 | LANA | 344 | MONTILLA | 273 | QUINTA | 340 | SYDNEY | 83 | ZENIA | 546 |
| BODRUM | 297 | CUADRO | 360 | GIRONA | 314 | LANCE | 394 | MONZA | 414 | RADIATOR | 492 | TAILOR | 178 | ZODIAC | 265 |
| BOLDER | 363 | CURL | 228 | GONZALO | 332 | LEON | 468 | MORGAN | 312 | RADO | 443 | TAJO | 449 | ZUCCA | 252 |

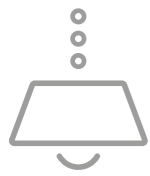

PENDELLEUCHTEN & KRONEN

Pendants & chandeliers · Lustres & suspensions · Hanglampen & kroonluchters · Colgantes y Lámparas · Lampadari e sospensioni · Lustre si pendule · Riippu- & kruunu · Wiszące i żyrandole



MARNIE 60



NURIA 71

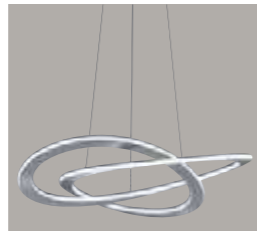

OAKLAND 81



FRANCIS 80

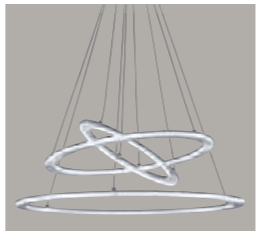

DURBAN 229

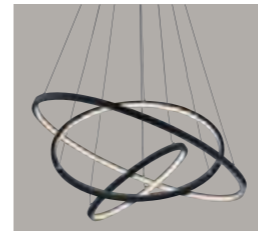

AARON 49



THOMPSON 47



CARRERA 82



CURL 228

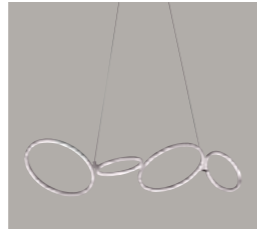

RONDO 86

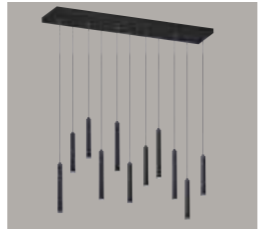

TUBULAR 226



TRAY 88



FRANKLIN 66

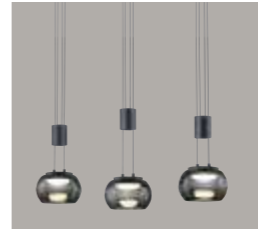

MADISON 94



CHARIVARI 72



SALINAS 76



SEQUENCE 65

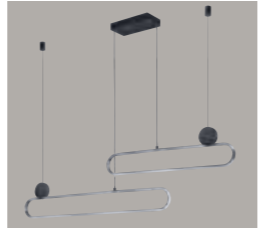

GRANT 225



EDGE 78



BLAZE 74

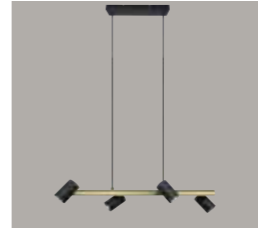

MARLEY 230



HELIOS 217

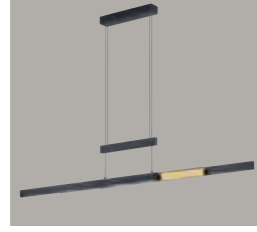

TRAJAN 218



LACAL 220



BELFAST 221



AICK 224



MERTON 222

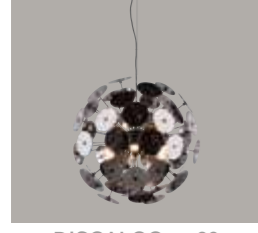

DISCALGO 98

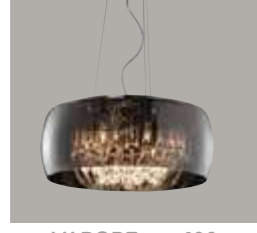

VAPORE 100



ALICIA 104



LORENA 105



BALINI 106



LUMINA 102



STANLEY 324



MELA 238



CLAYTON 236



PURE 110



ROBIN 108



FLETCHER 251

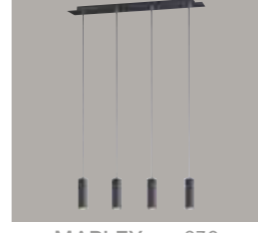

MARLEY 230



BARON 92



ZANDOR 90



FILO 250



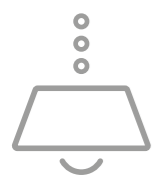

PENDELLEUCHTEN & KRONEN

Pendants & chandeliers · Lustres & suspensions · Hanglampen & kroonluchters · Colgantes y Lámparas · Lampadari e sospensioni · Lustre si pendule · Riippu- & kruunu · Wiszące i żyrandole

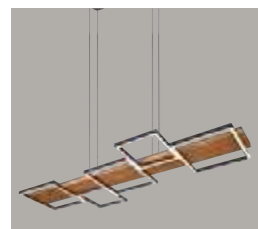

HARPER 164



DEACON 175



KERALA 173

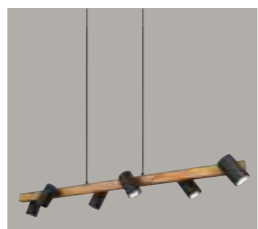

MARLEY 230



AGRA 204



BRAD 180

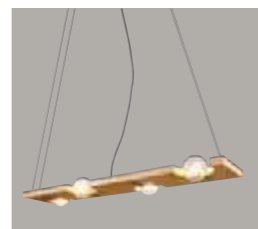

TAILOR 178



KHAN 183



BELL 199



DELHI 200



TAMIL 150



TOSH 208



INGA 186



RUNA 188



COLINO 190



HEDDA 184



BOOLAN 213



ROPE 212



JUDITH 212



HARRIS 206

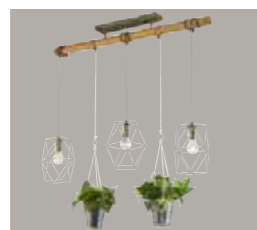

PLANT 211



ELMAU 194



ROSS 141



GARDA 139



BURTON 130



JULIETA 142



CAMDEN 118

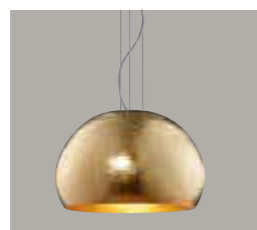

ONTARIO 241



CANDELA 240



LUCERNA 243



MINSK 242



ZUCCA 252



CORTEZ 248



LORELEY 245



HOSTEL 137



ROMINO II 244



CHIRAZ 247



ROXIE 147



LIVIA 249



CHIRON 246



AGUDO 144



CROSS 152



CORD 257



ONYX 254



RUSTICA 156



TRADITIO 160



SANNA 160



JASMIN 256



SANDRINA 116



SIGNA 117



SPIRELLI 115



ELISA 114



STAMINA 259



LEVISTO 258



VIOLA 261



DIEGO 260



PAPER 260



DECKENLEUCHTEN

Ceiling lamps · Plafonniers · Plafonnières · Plafones · Plafoniere · Plafoniere · Kattvalaisimet · Plafony

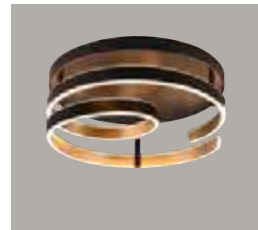

MARNIE 60



CAYA 266



ZODIAC 265



GRANADA 270



LUGO 268



CHARIVARI 72

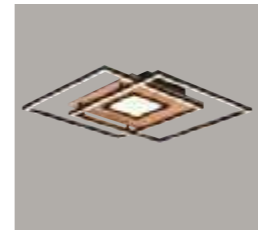

VIA 276

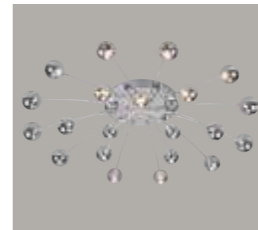

BULLET 294

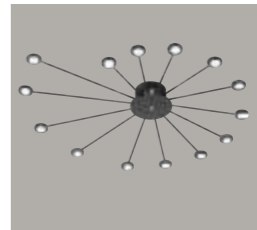

PEACOCK 296



BODRUM 297



NURIA 70



FRANCIS 80



OAKLAND 81



CARRERA 82



YAVA 285



JIVE 85



AARON 48



WINONA 291

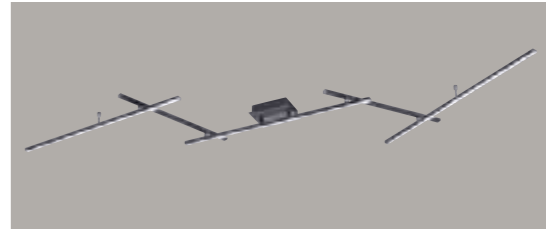

ARVIN 303



MONTILLA 273



GALE 286



RONDO 86



GROOVY 274



THIAGO 50

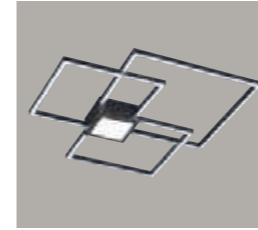

HYDRA 288



DOWNEY 284



THOMPSON 46

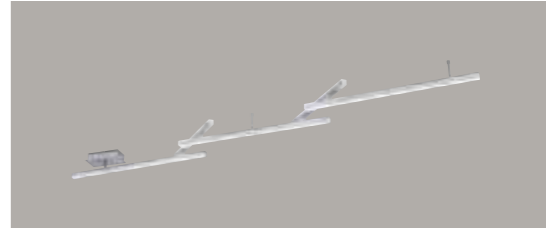

MELBY 53



SEDONA 280



TUCSON 281

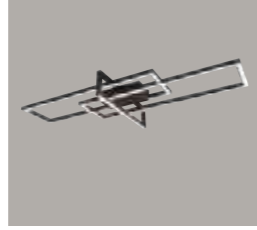

SALINAS 76



IRVINE 278



GANADO 290

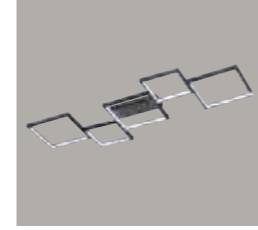

SORRENTO 282

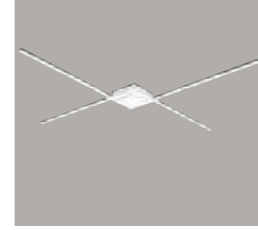

OXFORD 299

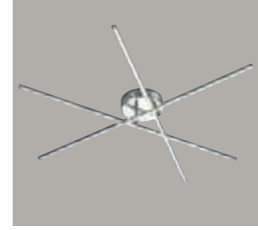

TIRIAC 298

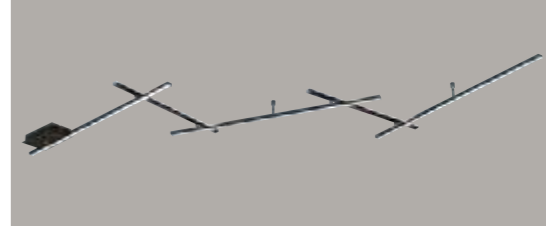

INDIRA 300



CHARLESTON 283



SYDNEY 83



SEQUENCE 62



BLAZE 74



HARPER 164



BARCA 166



RAMA 168



KERALA 172

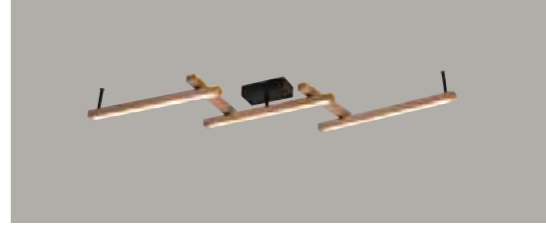

BELLARI 174



MEDERA 170



BRAD 180



TAILOR 178



KHAN 182



TAMIL 150



BELL 198



DEACON 175

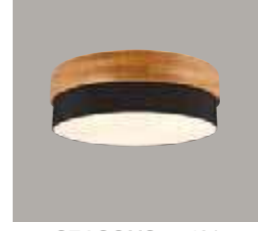

SEASONS 196

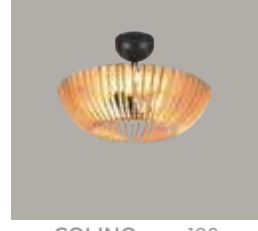

COLINO 190



INGA 186



HEDDA 184



ELMAU 194



PALI 342



DECKENLEUCHTEN

Ceiling lamps · Plafonniers · Plafonnières · Plafones · Plafoniere · Plafoniere · Kattvalaisimet · Plafony



VERUS 323



MIKO 325



TOKYO 327



OSAKA 324



NORIAKI 331



NAGANO 329



LUNAR 330



SHOGUN 328



SEIKO 326

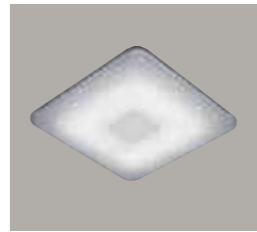

SAMURAI 328



NALIDA 56



CHARLY 56



GRIFFIN 54



TITUS 322



CESAR 333



GONZALO 332



KAGAWA 304



MITA 306

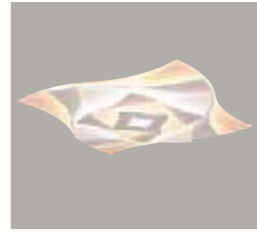

AKITA 305



WACO 309



DOHA 310



GIRONA 314



PHOENIX 316



TRAY 88



ZANDOR 90



BARON 92



FERNANDO 334



BISCUIT 339



COOKIE 337

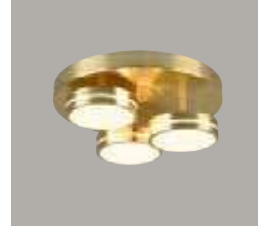

FRANKLIN 68



MORGAN 312



CHIROS 355



JULIETA 142



HOSTEL 136



BURTON 132

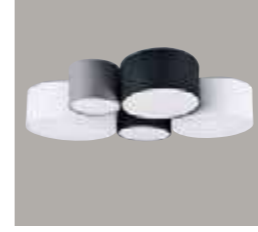

HOTEL 126



LUGANO 320



CAMDEN 118



DIAMO 57



DISCALGO 98



ALICIA 104



CRYSTEL 293



VAPORE 100



LORENA 105



ROXIE 148

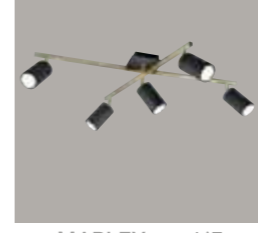

MARLEY 467



CLAPTON 457



GARDA 138



ROSS 140



AGUDO 144



QUINTA 340



RUSTICA 156



TRADITIO 160



CROSS 152



JOHANN 341



ADRIAN 345



SANDRINA 116



LANA 344



ELISA 114



SPIRELLI 115



SIGNA 117



LILLY 366



WANDLEUCHTEN

Wall lamps · Appliques · Wandlampen · Apliques ·
Appliques · Lämpi de perete · Seinävalaisimet · Scienne



MIGUEL 348



LACAPO 349



LOUIS 348



CONCHA 347



RAVEN 346



ADRIANO 351



PLATON 350



ZANDOR 90

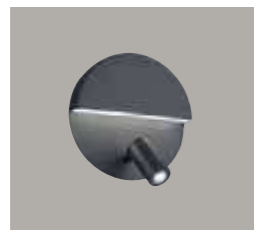

MARIO 358



JORDAN 357



ELEMENT 359



MARLEY 467



VISTA 52



WALES 350



SEQUENCE 62

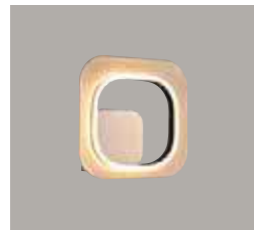

LUGO 268



MARRIOT 356



CASSIO 382

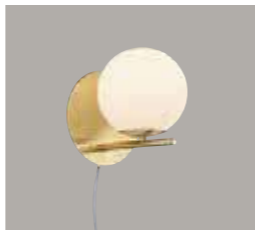

PURE 110



CHIROS 355



CLEO 354



BARCA 166



KERALA 172



ARINO 352



BRAD 180

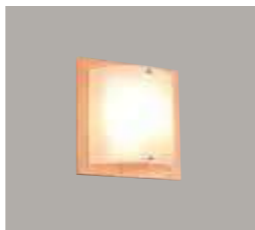

PALI 342



KHAN 182



RUNA 188



NILAM 193



LYON 122



HOTEL 124



EDWARD 423



KAZAN 418



CURTIS 430



CUADRO 360



BALDO 362



BOLDER 363



LINE 362



DIALLO 154



CAMPO 364



TRADITIO 161



PURA 365



ELISA 114



SANDRINA 116



SPIRELLI 115



SIGNA 117



DIVO 364



ROMA 367



ZAZOU 366





TISCHLEUCHTEN

Table lamps · Lampes de table · Tafellampen · Sobremesas ·
Lampa da tavolo · Veioze · Pöytävalaisimet · Lampy stołowe



CHARIVARI 73



FRANKLIN 68



MADISON 95



RONDO 87



SYDNEY 83



EDGE 78



SEQUENCE 63



BLAZE 74



TEXEL 392



VAPORE 100



LORENA 105



ROBIN 108



KERALA 173



TAILOR 178



INGA 186



ELMAU 194



JULIETA 142



BALE 428



ROSS 141



SABIA 384



CASSIO 382



PARIS II 389



LYON 122



NANDOR 390



HOTEL 128

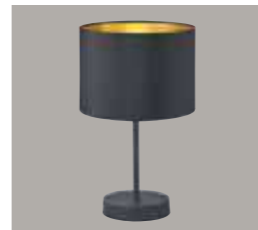

HOSTEL 136



BURTON 130



MATS II 438



GARDA 138



NOLA 429



JOOST II 432



BERLIN 435



DONNA 432



PURE 110



VENTURA 433



LUIS II 438



EMERALD 434



FYNN II 439



CRISTO 434



ARY II 436



TILL II 436



DAVI II 437



DIALLO 154



RUSTICA 158



TRADITIO 161



AMSTERDAM 440



AVA 441



VARIO 442



RADO 443



MONZA 414



BERGAMO 412



PAVIA 416



CURTIS 430



NARCOS 459



MARLEY 424



KIMI 444



TOSH 209



ROXIE 147



PERRY 445



POLO 446



LUPO 447



PRONTO 448



TAJO 449



WANDA 368



FLEXO 446



STEHLEUCHTEN

Floor lamps · Lampadaires · Vloerlampen · Lámparas de pie · Piantane · Lampadare · Lattiavalaisimet · Lamy podłogowe



CAMDEN 118



LYON 123



SABIA 384



PARIS II 389



CASSIO 382

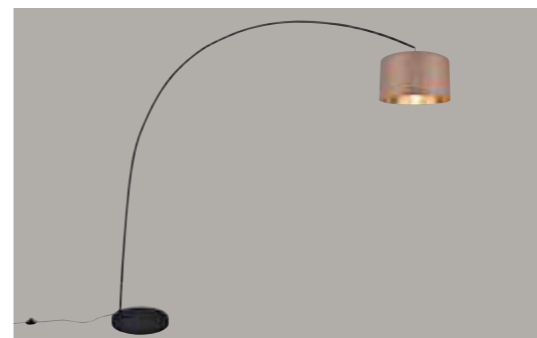

MANSUR 378



HOTEL 124



MOTEL 387



BURTON 134



CLAAS 388

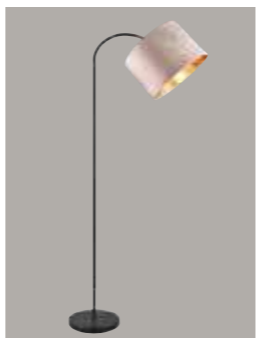

JULIETA 142



CLARK 380



TRACY 381



NANDOR 390



HOTEL 124



HOSTEL 136



ROSS 140



CROSS 152

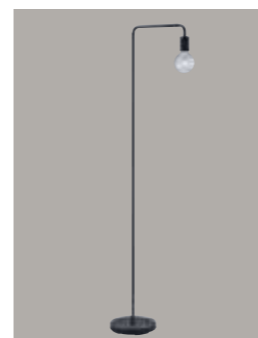

DIALLO 154



KERALA 173



BELLARI 174



BELL 198



TAILOR 178



KHAN 183

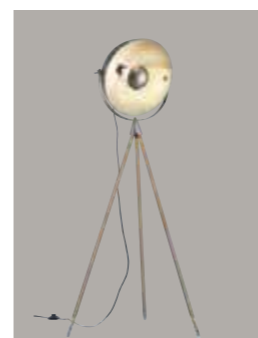

DELHI 202



KORBA 192



HEDDA 184



RUNA 188



TOSH 209



HARRIS 206



RODRIGO 205



LIEGE 393





STEHLEUCHTEN

Floor lamps · Lampadaires · Vloerlampen · Lámparas de pie · Piantane · Lampadare · Lattiavalaisimet · Lampy podłogowe

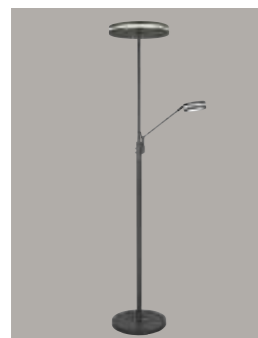

FRANKLIN 66



QUEBEC 400

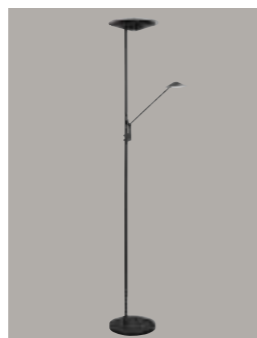

BRANTFORD 402

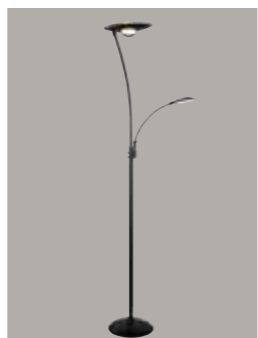

GRANDBY 404



BARRIE 406



SHANGHAI 399



BANGKOK 398



SOLA 396

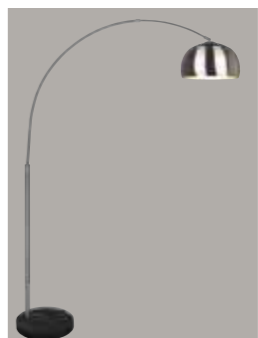

ARGENTINA 397

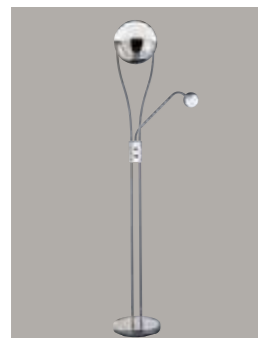

CHRIS 408

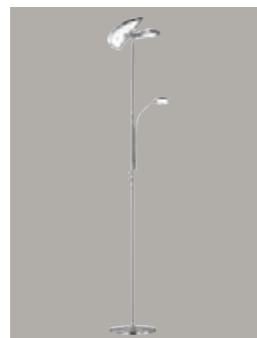

SPLIT 409



SANTO II 411

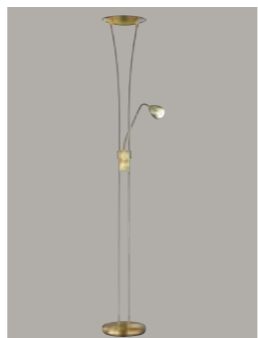

ARIZONA 410



RUSTICA 158



NURIA 71



JIVE 85



RONDO 87



SYDNEY 83



CHARIVARI 73



SEQUENCE 65



BLAZE 74



EDGE 78



TEXEL 392



VAPORE 101



LUMINA 102

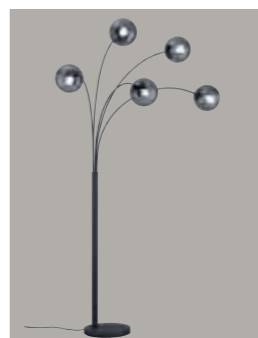

BALINI 106



LANCE 394



FRANKLIN 66

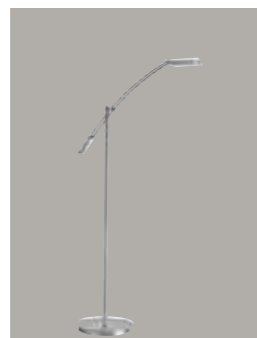

VERONA 413

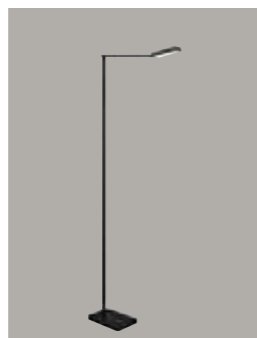

PAVIA 416

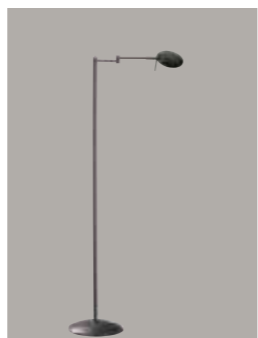

KAZAN 418



MONZA 414



BERGAMO 412



PURE 112

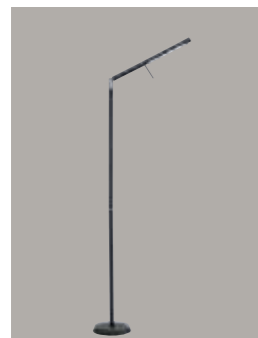

FILIGRAN 421

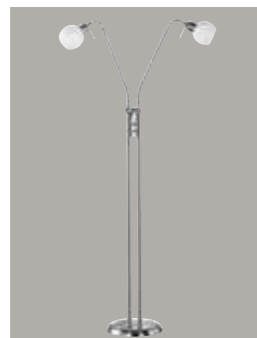

FREDDY 426



ICARO 427

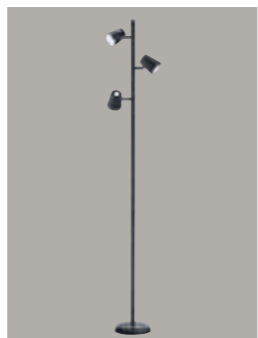

NARCOS 459

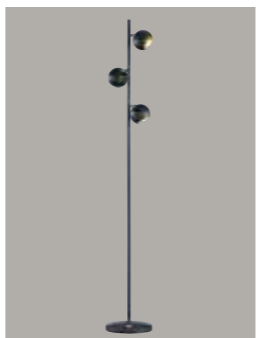

DACOTA 422

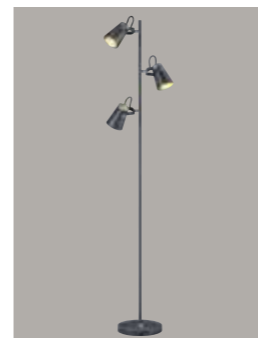

EDWARD 423



ROXIE 147

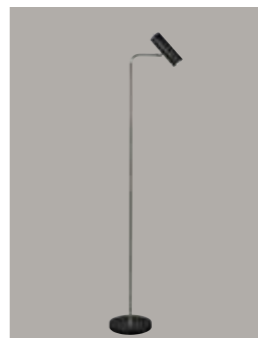

MARLEY 424

24

25

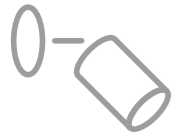

SPOTSERIEN

Spots · Spotterie · Spots · Focos · Faretti · Spoturi · Spotit · Reflektorki



CLAPTON 456

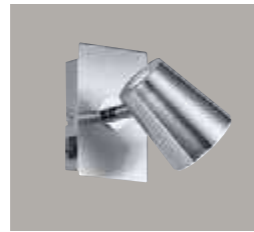

NARCOS 458



TAURUS 452



GUAYANA 455



PAGO 471



ANGELO 536



MARLEY 466



MICHAEL 470



LEVISTO 472



ARUNI 176



BELL 198



DELHI 202



TOSH 208



MADRAS 210



ROXIE 148



BURTON 132



STEAM 476



WANDA 368



LEVISTO 370



LIGARA 370



2-PHASEN-SCHIENENSYSTEM



2-phase track system · Système de voie à deux phases · 2-fase-spoorsysteem · Sistema de rieles en 2 fases · Sistema a binario bifase · Sistem de piste cu 2 faze · 2-vaihekiskojärjestelmä · 2-fazowy system prowadnic



RADIATOR 492



LEON 492



MARLEY 494



ROUBAIX 492



ANTIBES 496



TOSH 497



DIALLO 497



TOMMY 500



CAMILIUS 498



PANEL 498



HOTEL 500



HOSTEL 501

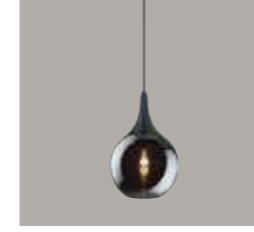

LUMINA 496



ROBIN 496



MARLEY 494



HOTEL 500



HOSTEL 501



JIMMY 500



ONTARIO 496

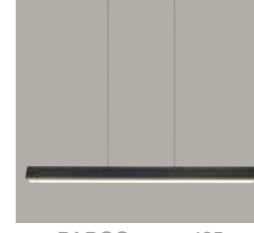

PAROS 495



EIN- UND UNTERBAULEUCHTEN

Recessed and cabinet lightings · Eclairages encastrés et éclairages sous armoire ·
Inbouwverlichtingen en verlichtingen onder de kastjes · Luces empotrables y luces para la parte inferior
del armario · Lampade da incasso e lampade sottopensili · Lumini încestate și lumini sub dulap ·
Upotettavat valaisimet ja kaapinalusvalaisimet · Oprawy wpuszczane oraz oprawy podszafkowe

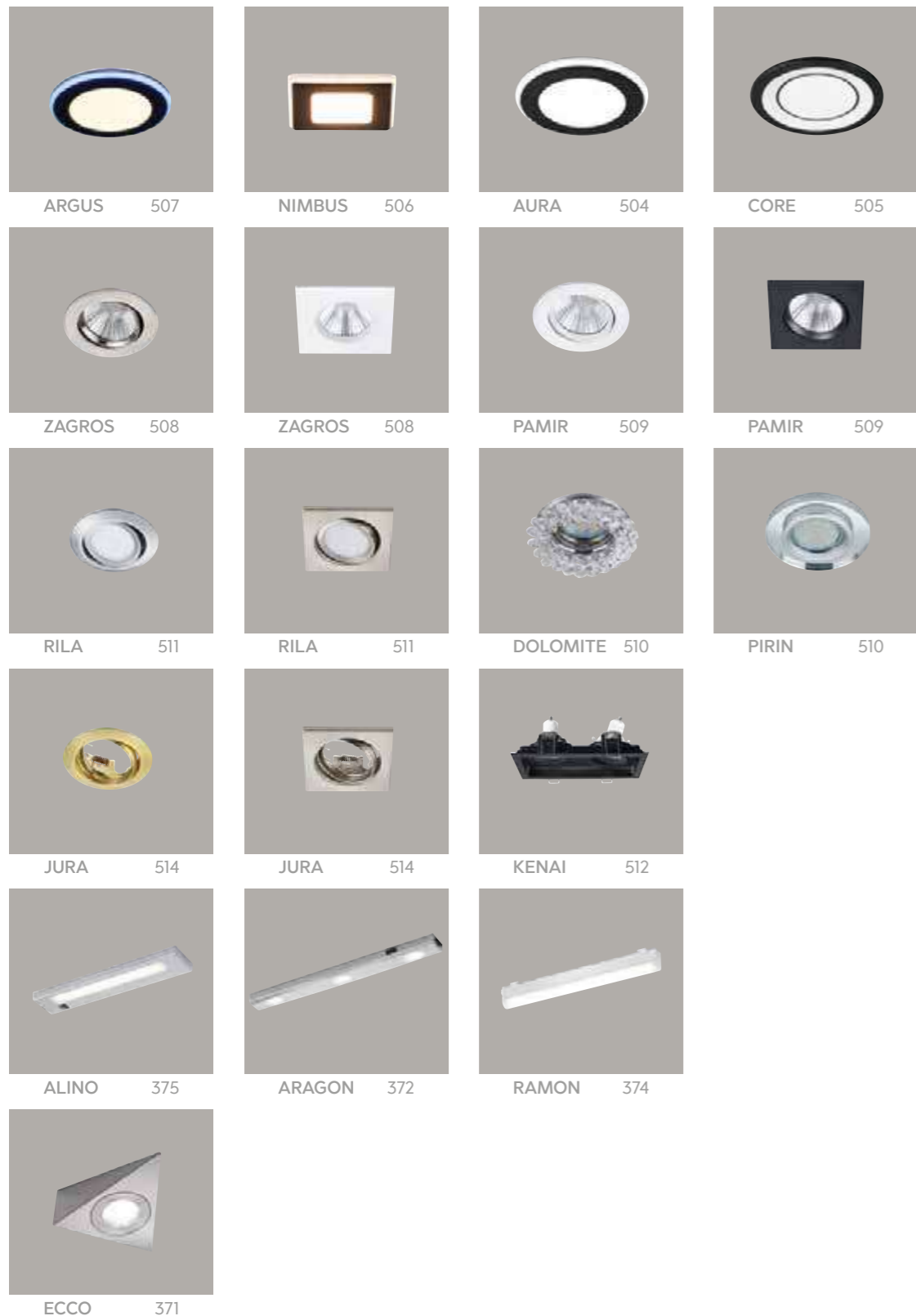

BADEZIMMERLEUCHTEN H_2O

Bathroom lighting · Éclairage salle de bains · Badkamer verlichting · Iluminación de cuarto de baño ·
Illuminazione per bagno · Iluminat baie · Kylpyhuone valaistus · Oświetlenie łazienkowe



TREND HIGHLIGHTS

2023/24

Coffee



D Es gibt doch nichts Schöneres, als sich bei der Gestaltung der eigenen vier Wände an den Farben der Natur zu orientieren. Die dezenten Creme- und Brauntöne sind vielseitig kombinierbar, verleihen Räumen eine einladende Wärme und erfüllen zugleich das Bedürfnis nach Ruhe und Behaglichkeit.

GB There is nothing more beautiful than orientating yourself on the colours of nature when designing your home. The subtle shades of cream and brown can be combined in many ways, giving rooms an inviting warmth and at the same time fulfilling the need for peace and comfort.

FR Il n'y a rien de plus beau que de vous inspirer des couleurs de la nature lors de la conception de votre maison. Les nuances subtiles de crème et de marron peuvent se marier de plusieurs façons, donnant aux pièces une chaleur accueillante tout en répondant au besoin de paix et de confort.



AGUDO
Seite / page 145

NL Er is niets mooiers dan zich op de kleuren van de natuur te oriënteren bij het inrichten van je woning. De subtiele crème- en bruintinten kunnen veelzijdig gecombineerd worden, geven kamers een uitnodigende warmte en vervullen tegelijkertijd de behoefte aan rust en comfort.

ES No existe nada más hermoso que inspirarse en los colores de la naturaleza a la hora de diseñar su hogar. Los tonos sutiles crema y marrón se pueden combinar de diversas maneras, lo que le aporta a los espacios una calidez acogedora y, al mismo tiempo, crea un hogar lleno de paz y comodidad.

IT Quando si progetta la propria casa, non c'è cosa più bella che lasciarsi ispirare dai colori della natura. La delicatezza delle tonalità del panna e del marrone si presta a molteplici combinazioni, che conferiscono agli ambienti un calore avvolgente e che appagano al contempo l'esigenza di pace e di comfort.

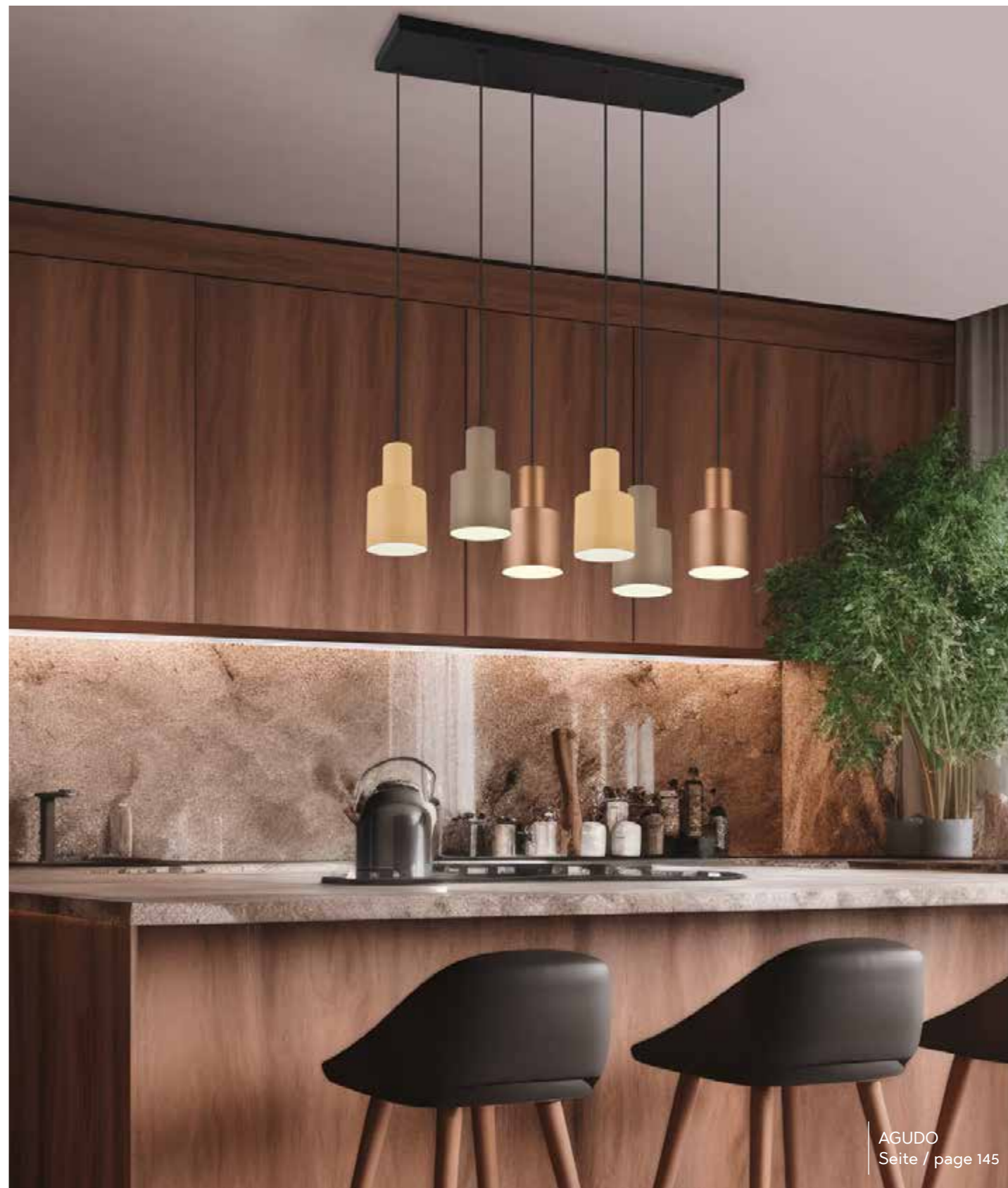

AGUDO
Seite / page 145

RO Nimic nu este mai plăcut decât să alegeți culorile naturii atunci când vă organizați căminul. Nuanțele subtile de crem și maro se pot combina în nenumărate moduri, oferind încăperilor o căldură primitoare și răspunzând, în același timp, nevoii de pace și confort.

FI Ei ole mitään kauniimpaa kuin luonnon värien huomioiminen kodin sisustuksessa. Herkkiä kerman ja ruskean sävyjä voidaan yhdistellä monella tavalla antaen huoneille lämpöä samalla täyttäen rauhallisuuden ja mukavuuden tarpeen.

PL Przy projektowaniu wnętrza swojego domu nie ma nic piękniejszego niż pójście w kierunku kolorów natury. Subtelne odcienie kremowe i brązowe można łączyć na wiele sposobów, nadając pomieszczeniom pociągające ciepło, zaspokajając jednocześnie potrzebę spokoju i komfortu.



BARCA
Seite / page 167

(NL) Als het gaat om het inrichten van woonruimtes, heerst er een duidelijke trend voor natuurlijke materialen. Dit gaat hand in hand met het toenemende bewustzijn van duurzaamheid. Hout is hierbij een belangrijk element. Vooral combinaties van licht hout met wittinten ogen aangenaam ingetogen en gezellig.

(ES) Cuando se trata de diseño de interiores, hay una tendencia marcada hacia los materiales naturales. Esta tendencia va de la mano de la mayor concientización por la sustentabilidad, y la madera toma un papel protagónico. En especial, las combinaciones de madera clara con tonos blancos causan una sensación de sobriedad y comodidad que resulta placentera a la vista.

(RO) În designul interior există o tendință clară de folosire a materialele naturale. Această tendință merge mână în mână cu conștientizarea tot mai mare a sustenabilității. Lemnul reprezintă elementul central în această tendință. În special combinațiile de lemn deschis la culoare cu nuanțe de alb asigură un efect limitat și extrem de primitiv.

(FI) Sisätilojen suunnittelussa luonnolliset materiaalit muodostavat selvän trendin. Tietoisuus kestävästä kehityksestä lisääntyy, ja trendi kulkee sen kanssa käsi kädessä. Puu on tässä keskeinen elementti. Vaalean puun yhdistelmä valkoisilla sävyillä luo erityisen miellyttävän hillityn ja kodikkaan tunnelman.

(IT) Nel settore dell'arredamento d'interni, si registra una netta predilezione per i materiali naturali, una tendenza che si sposa con la crescente sensibilità al tema della sostenibilità. In un simile contesto, il legno è un elemento centrale. Gli accostamenti tra il legno chiaro e i toni del bianco, in particolare, conferiscono un effetto gradevole, raccolto e accogliente.

(PL) Jeśli chodzi o aranżację wnętrz, panuje wyraźny trend ukierunkowany na naturalne materiały. Trend ten idzie w parze z coraz większą świadomością w kwestii zrównoważonego rozwoju. Centralnym elementem jest tu drewno. W szczególności połączenie jasnego drewna z odcieniami bieli dają przyjemnie powściągliwy, a jednocześnie przytulny efekt.

Natur & Design

Nature & Design · Nature et design ·
Natuur en design · Naturalidad & Diseño ·
Natura e design · Natură și design ·
Luonto ja suunnittelu · Naturalność i dizajn



ARUNI
Seite / page 177

(D) Bei der Wohnraumgestaltung hält sich ein klarer Trend zu natürlichen Materialien. Dieser geht mit dem zunehmenden Bewusstsein für Nachhaltigkeit einher. Dabei bildet Holz ein zentrales Element. Vor allem Kombinationen aus hellem Holz mit Weißtönen wirken angenehm zurückhaltend und gemütlich.

(GB) When it comes to interior design, there is a clear trend towards natural materials. This trend goes hand in hand with the increasing awareness of sustainability. Wood is a central element in this. Combinations of light wood with white tones in particular have a pleasantly restrained and cosy effect.

(FR) Lorsqu'il s'agit de design intérieur, la tendance est nettement orientée vers des matériaux naturels. Cette tendance va de pair avec une sensibilisation accrue de la durabilité. Le bois y est un élément central. Des combinaisons de bois clair et de teintes blanches en particulier ont un effet agréablement discret et cosy.

Materialmix aus Stoff und Metall

Material mix of fabric and metal · Mélange de tissu et de métal ·
Materiaalmix van stof en metaal · Combinación de tejidos y metal ·
Combinazione di materiali: tessuto e metallo ·
Combi-nație de materiale textile și metal ·
Kankaan ja metallin sekoitus ·
Łączenie materiałów – tkanina i metal

34

Die mattschwarzen Metallgestelle sind von klaren Strukturen und Understatement geprägt. In Kombination mit naturfarbenen Textilschirmen strahlen die Leuchten Wärme und Gemütlichkeit aus – perfekt für all jene, die Schlichtheit suchen und es trotzdem romantisch mögen.

The matt black metal frames are characterised by clear structures and understatement. In combination with natural-coloured textile shades, the lights radiate warmth and cosiness – perfect for all those who are looking for simplicity and still like it romantic.

Les cadres métalliques noirs mats sont caractérisés par des structures claires et de la sobriété. En combinaison avec des nuances textiles aux couleurs naturelles, les lumières rayonnent de chaleur et de confort – parfaites pour toutes celles et ceux qui recherchent de la simplicité et aiment le romantisme.



De matzwarte metalen frames worden gekenmerkt door heldere structuren en understatement. In combinatie met naturelkleurige stoffen lampenkappen stralen de lampen warmte en gezelligheid uit – perfect voor wie op zoek is naar eenvoud en toch van romantiek houdt.

Los marcos de metal negro se caracterizan por sus estructuras definidas y su simpleza. En combinación con tonos textiles de color natural, las luces irradian calidez y comodidad. Por lo tanto, son perfectas para aquellos que buscan la simpleza y, aun así, disfrutan de un toque romántico en el ambiente.

Le strutture in metallo nero opaco sono caratterizzate da linee chiare e sobrie. Abbinare alle tonalità naturali dei tessuti, le lampade irradiano calore e intimità: la soluzione perfetta per chi cerca la semplicità e ama il romanticismo.



ROSS
Seite / page 141

Cadrelle mate negre din metal se caracterizează printr-o structură clară și lipsă de emfază. În combinație cu abajururi din materiale textile în culori naturale, lămpile radiază căldură și o atmosferă plăcută – ideală pentru toți cei care își doresc simplitate și încă apreciază romantismul.

Matan mustilla rungoilla on vaaleat rakenteet ja perustat. Yhdessä luonnonväristen tekstiilisävyjen vaaleiden sävyjen kanssa ne sädehtivät lämpöä ja kodikkuutta – täydellinen niille, jotka etsivät yksinkertaisuutta romantiikasta luopumatta.

Czarne matowe metalowe oprawy charakteryzują się przejrzystą strukturą i pewnym niedopowiedzeniem. Światła w połączeniu z tekstylnymi abażurami w naturalnym kolorze emanują ciepłem i przytulnością – jest to idealne rozwiązanie dla wszystkich osób, które szukają prostoty, a przy tym lubią mają romantyczną duszę.

Design & Funktionalität

Design & functionality · Design et fonctionnalité · Design en funcionaliteit · Diseño & Funcionalidad · Design e funzionalità · Design și funcționalitate · Suunnittelu ja toimivuus · Model i funkcjonalność

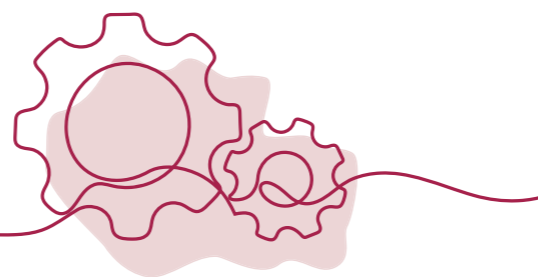

D Tischbeleuchtung sollte stimmungsvoll, aber auch situativ anpassbar sein. Die Pendelleuchte Helios zeichnet sich durch außergewöhnliches Design und exzellente Lichteigenschaften aus. Auf Knopfdruck sorgt sie nicht nur für das nötige Maß an Helligkeit, sondern bietet zugleich eine horizontale Verstellmöglichkeit, wodurch sich jegliche Tischsituationen spielend leicht meistern lassen.

GB While table lighting should be atmospheric, it should also be adaptable to the situation. The Helios pendant luminaire is characterised by exceptional design and excellent lighting properties. At just the touch of a button, not only does it provide the necessary level of brightness, but it also offers a horizontal adjustment option, making it easy to master any table situation.

FR Bien que l'éclairage de table doive être atmosphérique, il doit également s'adapter à la situation. Le luminaire suspendu Helios se distingue par un design exceptionnel et d'excellentes propriétés d'éclairage. En appuyant simplement sur un bouton, il apporte non seulement le degré nécessaire de luminosité, mais offre également une option de réglage horizontal, permettant de maîtriser toute atmosphère de table.

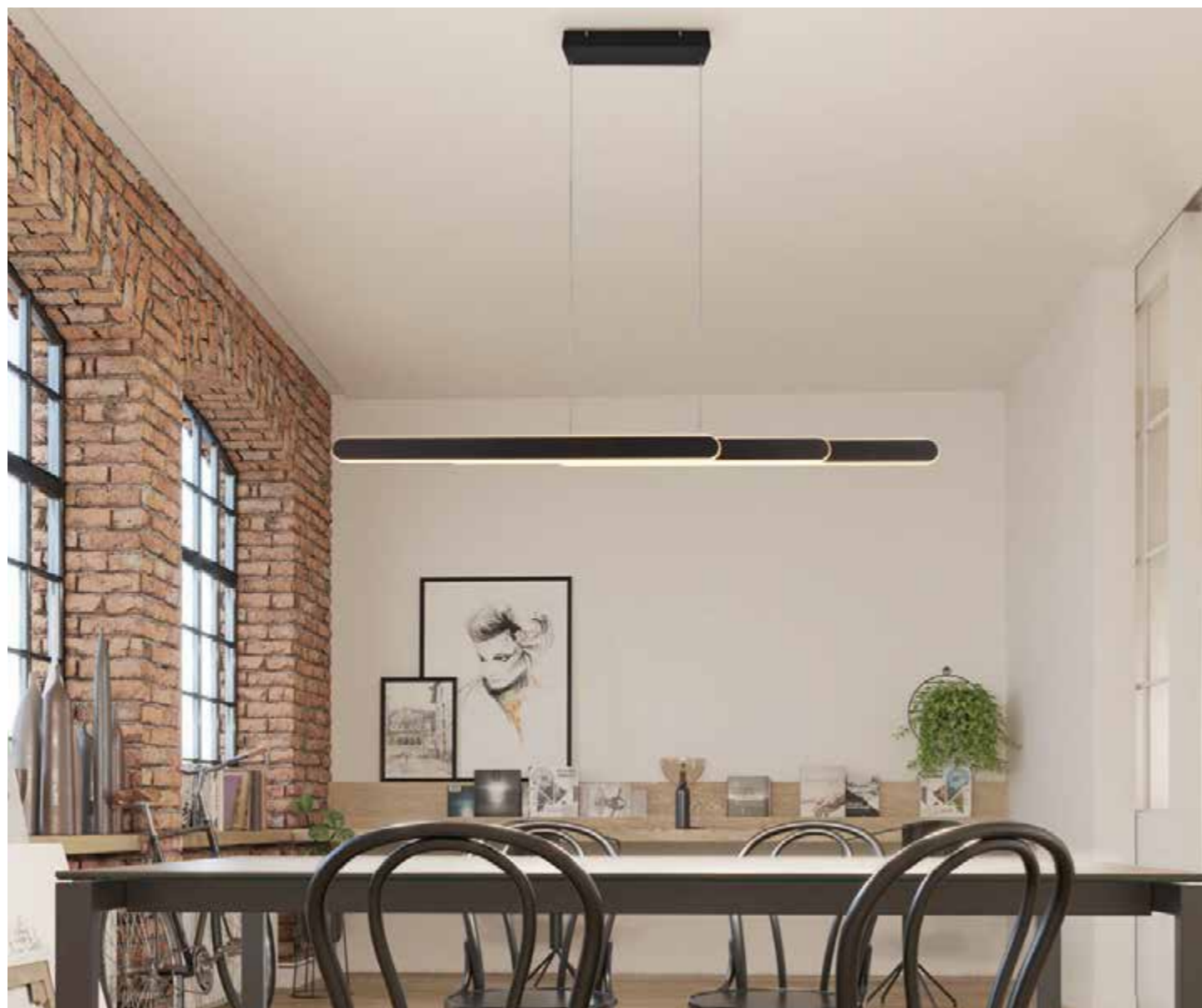

HELIOS
Seite / page 217

NL Tafelverlichting moet sfeervol zijn, maar ook aanpasbaar aan de situatie. De hanglamp Helios kenmerkt zich door haar buitengewone design en uitstekende lichteigenschappen. Met een druk op de knop zorgt ze niet alleen voor de nodige helderheid, maar biedt tegelijk een horizontale verstelmogelijkheid, waardoor elke tafelsituatie met gemak kan worden beheerst.

RO Deși iluminatul mesei trebuie să creeze o anumită atmosferă, el trebuie să fie și ușor adaptabil diferitelor situații. Lustra Helios se caracterizează printr-un design excepțional și proprietăți excelente de iluminat. Prin simpla atingere a unui buton nu oferă doar nivelul necesar de luminozitate, ci și o opțiune de reglare pe orizontală, făcând-o potrivită pentru toate situațiile.

ES Si bien la iluminación de mesa debe ser ambiental, es importante que se pueda adaptar a la situación. La luminaria colgante Helios se caracteriza por tener un diseño excepcional y propiedades lumínicas excelentes. Cuando pulsa el botón, no solo obtiene el nivel de luz necesario, sino que también ofrece una opción de ajuste horizontal, que facilita el manejo de la iluminación en la mesa.

FI Pöytävalaistuksesta halutaan tunnelmallinen, mutta samalla sen tulisi mukautua tilanteeseen. Helios-riippuvalaisin on malliltaan erilainen erinomaisilla valaistusominaisuuksillaan. Painikkeen painalluksella ei saada vain tarvittavaa valaistusta, se tarjoaa myös vaakasoran säätövaihtoehtoon, jota on helppo vaihdella pöydän ääressä.

IT Se è vero che l'illuminazione della tavola deve creare atmosfera, è altrettanto vero che deve sapersi adeguare alle circostanze. La lampada a sospensione Helios è caratterizzata da un design straordinario e da eccellenti proprietà di illuminazione. Con la semplice pressione di un pulsante, oltre a garantire la luminosità necessaria, consente di regolare la luce in senso orizzontale e di gestire agevolmente le varie circostanze di utilizzo del tavolo.

PL Choć oświetlenie stołu powinno być nastrojowe, musi być również dostosowane do sytuacji. Oprawa wiszącej lampy Helios charakteryzuje się wyjątkowym wzornictwem i doskonałymi właściwościami oświetleniowymi. Naciśnięcie jednego przycisku zapewnia nie tylko wymagany poziom jasności, ale także opcję regulacji poziomej, co ułatwia dostosowanie do każdej sytuacji na stole.



DOHA
Seite / page 311

NL Minimalisme is een van de hipste woontrends, het is tijdloos en ingetogen. Een inrichtingsstijl gebaseerd op helderheid en functionaliteit. Eenvoudige vormen en subtiele kleuren garanderen een sfeer en puristische elegantie zonder franjes.

ES El minimalismo es una de las tendencias de moda en el mundo de las viviendas. Es atemporal y sobrio, un estilo de diseño de interiores basado en la claridad y funcionalidad. Las formas simples y los colores discretos garantizan un ambiente sencillo y una elegancia refinada.

IT Il minimalismo è una delle tendenze più in voga nel settore dell'arredamento: intramontabile e sobrio. Uno stile di interior design improntato alla chiarezza e alla funzionalità. Forme sobrie e colori discreti garantiscono un ambiente senza eccessi e un'eleganza purista.

RO Minimalismul este una dintre cele mai în vogă tendințe în stilul de viață – este atemporal și sobru. Un stil de design interior bazat pe claritate și funcționalitate. Formele simple și culorile discrete garantează un mediu lipsit de ornamente inutile și o eleganță severă.

FI Minimalistisuus on yksi kuumimmista trendeistä – se on ajatonta ja hillittyä. Sisätilojen suunnittelutyö perustuu kirkkauteen ja toimivuuteen. Yksinkertaiset muodot ja hillityt värit takaavat selkeälinjaisen tunnelman ja puhtaan eleganssin.

PL Minimalizm to jeden z najgorętszych trendów w życiu – jest skromny i ponadczasowy. Styl aranżacji wnętrz opiera się na przejrzystości i funkcjonalności. Proste kształty i dyskretne kolory gwarantują przyjemną atmosferę i bezpretensjonalną elegancję.

Zeitlose Eleganz

Timeless Elegance · Éléance intemporelle ·
Tijdloze elegantie · Elegancia atemporal ·
Eleganza senza tempo · Eleganță atemporală ·
Ajatonta tyylikkyyttä · Ponadczasowa elegancja

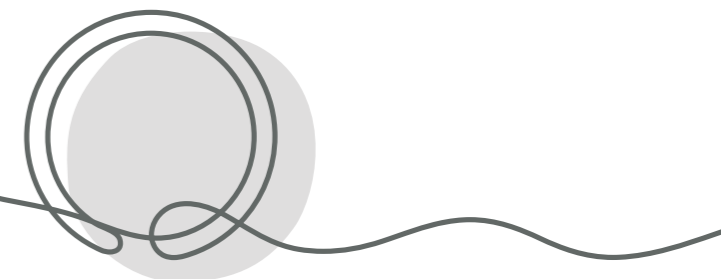

D Minimalismus zählt zu den angesagten Wohntrends, ist zeitlos und zurückhaltend. Ein Einrichtungsstil, der auf Klarheit und Funktionalität beruht. Schlichte Formen und dezente Farben garantieren ein schnörkelloses Ambiente und puristische Eleganz.

GB Minimalism is one of the hottest trends in living – it is timeless and restrained. An interior design style based on clarity and functionality. Simple shapes and discreet colours guarantee a no-frills ambience and purist elegance.

FR Le minimalisme est une des tendances les plus en vogue dans les logements – il est intemporel et discret. Un style de design intérieur basé sur la clarté et la fonctionnalité. Des formes simples et des couleurs discrètes garantissent une ambiance sans superflu et une pure élégance.



NOLA
Seite / page 429

Ein Klassiker in neuem Gewand

A classic in a new guise · Un classique dans une nouvelle forme ·
Een klassieker in een nieuw jasje · Un clásico reversionado ·
Un classico che si veste di nuovo · Un element clasic cu o nouă înfățișare ·
Klassinen uusi ominaisuus · Kłasyka w nowej odsłonie

D Zeitlos, geradlinig, schlicht und elegant. Sanfte, frische Farbtöne wie Pistaziengrün und leuchtendes Gelb vermitteln ein sonniges Gefühl und entsprechen dem Wunsch nach Wohnlichkeit und Entspannung. Die zusätzliche Beleuchtung im Fuß werdet die Lichtstimmung zusätzlich auf und sorgt für das gewisse Etwas.

GB Timeless, straightforward, simple and elegant. Soft, fresh shades such as pistachio green and bright yellow convey a sunny feeling and correspond to the desire for cosiness and relaxation. The additional lighting in the base additionally enhances the lighting mood and provides that certain something.

NL Tijdloos, rechthoekig, strak en elegant. Zachte, frisse kleuren zoals pistache-groen en knalgeel zorgen voor een zonnig gevoel en komen overeen met het verlangen naar comfort en ontspanning. De extra verlichting in de sokkel versterkt de licht sfeer en zorgt precies voor die extra toets.

ES Atemporal, claro, simple y elegante. Los tonos frescos y suaves, como el verde pistacho y el amarillo brillante aportan una sensación de luminosidad y hacen realidad el deseo de comodidad y relajación. Además, la iluminación adicional de la base realza el ambiente luminoso y aporta ese toque especial.

FR Intemporelles, directes, simples et élégantes. Des nuances fraîches et douces comme le vert pistache et le jaune clair transmettent une sensation ensoleillée et correspondent au désir d'intimité et de relaxation. L'éclairage supplémentaire dans le socle améliore en outre l'ambiance lumineuse et apporte ce petit plus.

IT Intramontabile, lineare, semplice ed elegante. Nuance morbide e fresche come il verde pistacchio e il giallo intenso infondono un'atmosfera solare e conciliano l'esigenza di intimità e relax. Il sistema di illuminazione supplementare alla base esalta ancor di più l'atmosfera luminosa e conferisce un tocco di originalità.



BALE
Seite / page 428



RO Atemporal, direct, simplu și elegant. Nuanțele blânde și proaspete, cum ar fi verdele fistic și galbenul strălucitor, redau un sentiment înșorit și corespund dorinței de confort și relaxare. Lumina suplimentară din bază sporește și mai mult sentimentul de luminositate și oferă o nuanță de inefabil.

FI Ajatonta, pelkistettyä, yksinkertaista ja tyylikästä. Pehmeät, raikkaat sävyt, kuten pistaasin vihreä ja kirkas keltainen tuovat mukanaan aurinkoisuutta ja lisäävät kodikkuutta ja rentouttavaa tunnelmaa. Lisävalaistus perusvalaistuksen lisäksi parantaa tunnelmaa ja tarjoaa jotain erikoista.

PL Ponadczasowość, bezpretensjonalność, prostota i elegancja. Miękkie, świeże odcienie pistacjowej zieleni czy jasnej żółci zapewniają poczucie nasłonecznienia i zaspokajają pragnienie przytulności i odprężenia. Dodatkowe oświetlenie przy podstawie jeszcze bardziej potęguje nastrój wywołany światłem i tworzy to coś.



THOMPSON
Seite / page 46

(NL) Slimme thuisverlichting wordt meer en meer populair. Intelligente verlichtingsregeling biedt niet enkel maximaal gemak en maximale flexibiliteit, het opent ook volledig nieuwe mogelijkheden voor een creatief verlichtingsdesign. Op deze manier kunnen levenskwaliteit, leefcomfort en veiligheid tot een nieuw niveau gebracht worden.

(ES) La iluminación de casas inteligentes se está volviendo cada vez más popular. El control inteligente de la iluminación no sólo ofrece la máxima comodidad y flexibilidad, sino que también da lugar a posibilidades completamente nuevas para el diseño creativo de la iluminación. De esta manera, la calidad de vida, comodidad y seguridad para vivir pueden alcanzar un nuevo nivel.

(RO) Iluminatul inteligent al locuințelor devine din ce în ce mai popular. Controlul iluminatului inteligent nu numai că oferă maximul de ușurință și flexibilitate, dar de asemenea deschide noi posibilități pentru designul creativ al iluminatului. În acest fel, calitatea vieții, confortul de trai și siguranța pot fi ridicate la un nou nivel.

(FI) Kotien älyvalaistuksesta on tulossa yhä suosittumpaa. Älykäs valonsäätely tarjoaa maksimaalista käytännöllisyyttä ja joustavuutta, sekä avaa täysin uusia mahdollisuuksia luovalle valaistussuunnittelulle. Tällä tavoin elämänlaatu, asuinmukavuus ja turvallisuus voidaan viedä uudelle tasolle.

(IT) L'illuminazione domestica smart sta diventando sempre più popolare. Il controllo intelligente dell'illuminazione non solo offre la massima comodità e flessibilità, ma apre anche nuove possibilità di progettazione creativa. In questo modo, la qualità della vita, il comfort abitativo e la sicurezza possono essere portati a un nuovo livello.

(PL) Inteligentne oświetlenie w domu staje się coraz bardziej popularne. Inteligentne sterowanie oświetleniem oferuje nie tylko maksymalną wygodę i elastyczność, ale także otwiera zupełnie nowe możliwości kreatywnego projektowania oświetlenia. W ten sposób jakość życia, komfort i bezpieczeństwo można przenieść na wyższy poziom.

Smartes Licht Smart lighting

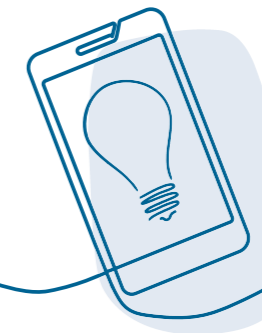

(D) Smart Home-Beleuchtung erfreut sich zunehmend, steigender Beliebtheit. Intelligente Lichtsteuerung bietet nicht nur ein Höchstmaß an Komfort und Flexibilität, sie eröffnet auch völlig neue Möglichkeiten der kreativen Lichtgestaltung. Auf diese Weise lassen sich Lebensqualität, Wohnkomfort und Sicherheit auf ein neues Level bringen.

(GB) Smart home lighting is becoming increasingly popular. Intelligent lighting control not only offers maximum convenience and flexibility, it also opens up completely new possibilities for creative lighting design. In this way, quality of life, living comfort and safety can be brought to a new level.

(FR) L'éclairage intelligent des maisons devient de plus en plus à la mode. Le contrôle de l'éclairage intelligent offre non seulement un grand confort et une flexibilité maximale, mais ouvre également de nouvelles possibilités pour une conception d'éclairage créatif. De cette façon, la qualité de vie, le confort de vie et la sécurité peuvent être hissés à un tout autre niveau.

Get your light connected.

Sensoren
Sensors

Sommer
Summer

Zeitpläne
Schedules

Warmweiß
Warm white

Tageslicht
Daylight

Momente
Moments

Party
Party

Sprachsteuerung
Voice control

Mojito
Mojito



64.000 **WEISSTÖNE**
64,000 **WHITES**

Einstellbare Lichtprogramme · Preset light modes

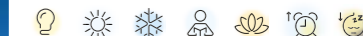

16 Millionen **FARBEN**
16 million **COLORS**

Dynamische Lichtprogramme · Dynamic light modes



trio-lighting.com/wiz



Mehrere Standorte

Kontrollieren und Steuern von mehreren Standorten gleichzeitig und von überall aus. Ob das eigene Zuhause oder die Ferienwohnung.

Multiple locations

Control and command multiple locations simultaneously and from anywhere. Whether your own home or your holiday home.

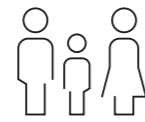

Mehrere Nutzer

Die Anzahl der Nutzer zur Steuerung der Leuchten kann individuell festgelegt werden.

Multiple user

The number of persons to control the lights can be set individually.



Cloud basiert

WiZ verbindet sich mit der Cloud, damit Vorlieben gespeichert, Wünsche geteilt und Updates automatisch generiert werden.

Cloud based

WiZ connects to the cloud to store preferences, share desires and generate updates automatically.



WiZ APP

Einfach und schnell installiert. Volle Funktionalität und Flexibilität mit der WiZ App – erhältlich im App Store oder bei Google Play.

Easy and quick to install. Full functionality and flexibility with the WiZ App – available on the App Store or on Google Play.



WiZ MOTE

Steuerung über die Fernbedienung und Abspeichern von vier favorisierten Lichtmodi möglich.

Control via the remote control and possibility to save four favorite light modes.

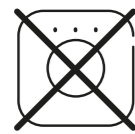

Keine zusätzliche Bridge erforderlich

Es wird keine zusätzliche Bridge oder Hub für die Steuerung der Leuchten benötigt.

No additional hub needed

There is no need for an additional bridge or hub to control the lights.



Mehrere Räume

Alle Leuchten können unterschiedlichen Räumen zugeordnet und präzise gesteuert werden – einzeln oder in Gruppen.

Several rooms

All lights can be assigned to different rooms and precisely controlled – individually or in groups.



WiZ MAGIC

Steuerung der Leuchten über Zeitpläne, Sensoren oder einfache Sprachbefehle. Kompatibel mit Amazon Alexa und Google Home.

Control of the lights by time schedules, with sensors or by simple verbal commands. Compatible with Amazon Alexa and Google Home.

DIMMEN DIMMING



64.000 WEISSTÖNE
64,000 WHITES

Einstellbare Lichtprogramme · Preset light modes



16 Millionen FARBEN
16 million COLORS

Dynamische Lichtprogramme · Dynamic light modes



Wlan Technologie

WiZ nutzt Wlan-Technologie als sichere, unabhängige, kostengünstige und einfach zu installierende Funklösung.

WiFi technology

WiZ uses Wi-Fi technology as a secure, independent, affordable and easy-to-install wireless solution.

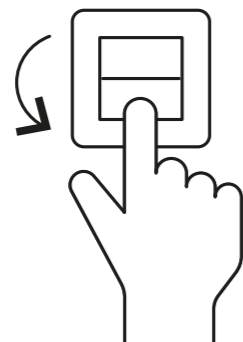

WiZ CLICK

Einfach und effektiv. Zwei bevorzugte Lichtmodi können über den vorhandenen Lichtschalter bedient werden.

Simple and effective. Two preferred light modes can be operated via the existing light switch.

30 Sekunden zur Installation · 30 seconds to install



Die Lampe installieren
Install a lamp



Wählen Sie den „Koppeln“ Modus
Start pairing



3 x EIN / AUS
3 x ON/OFF



Die Lampe beginnt „blau“ zu blinken und schaltet danach auf weiß
Light turns blue then goes white



Die Einstellungen sind nun gespeichert, jeder kann zu Hause WiZ nutzen.
The settings are now saved! Now everyone can use WiZ at your home.

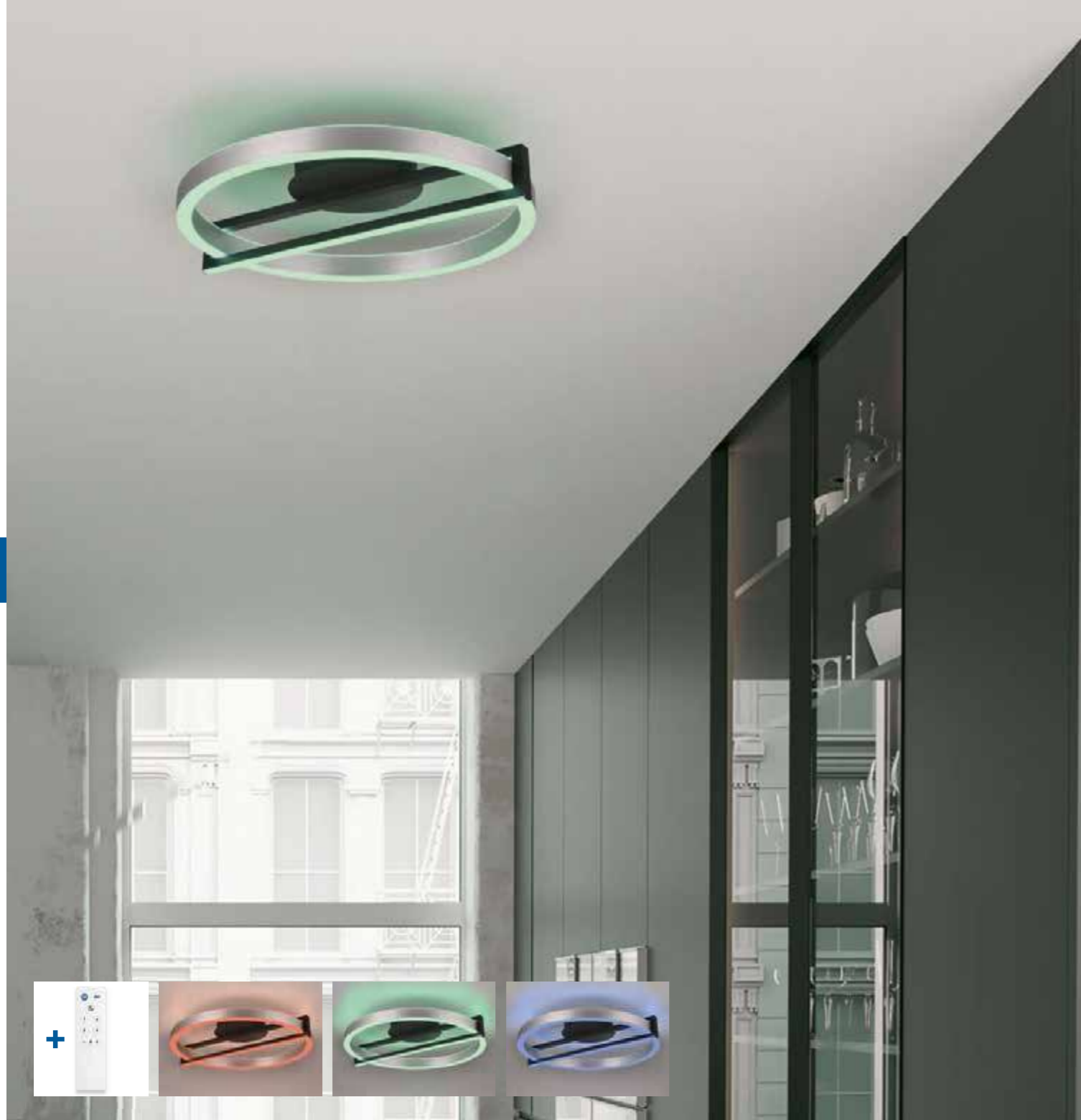

THOMPSON

Metall, Aluminium gebürstet, Schwarz matt · metal, brushed aluminium, black mat ·
 métal, aluminium balayé, noir mat · metaal, geborsteld aluminium, mat zwart · metal, aluminio pulido, estera negra ·
 metallo, alluminio spazzolato, nero opaco · metal, aluminiu lucios, negru mat ·
 metalli, harjattu alumiini, mattamusta · metal, aluminium szczotkowane, czarny mat

SMART LIGHTING

 RGB Farbwechsler ·
 RGB Colorchanging

 Lichtfarbe stufenlos einstellbar ·
 Light color infinitely variable

 Memory Funktion ·
 Memory function



Deckenleuchte · Ceiling lamp
 Ø 52 cm, ↑ 12 cm
 incl. SMD-LED, 55 W
 5.500 lm, 2.700 - 6.000 K



653810305



Pendelleuchte · Pendant
 Ø 52 cm, ↓ 150 cm
 incl. SMD-LED, 55 W
 5.500 lm, 2.700 - 6.000 K



353810305

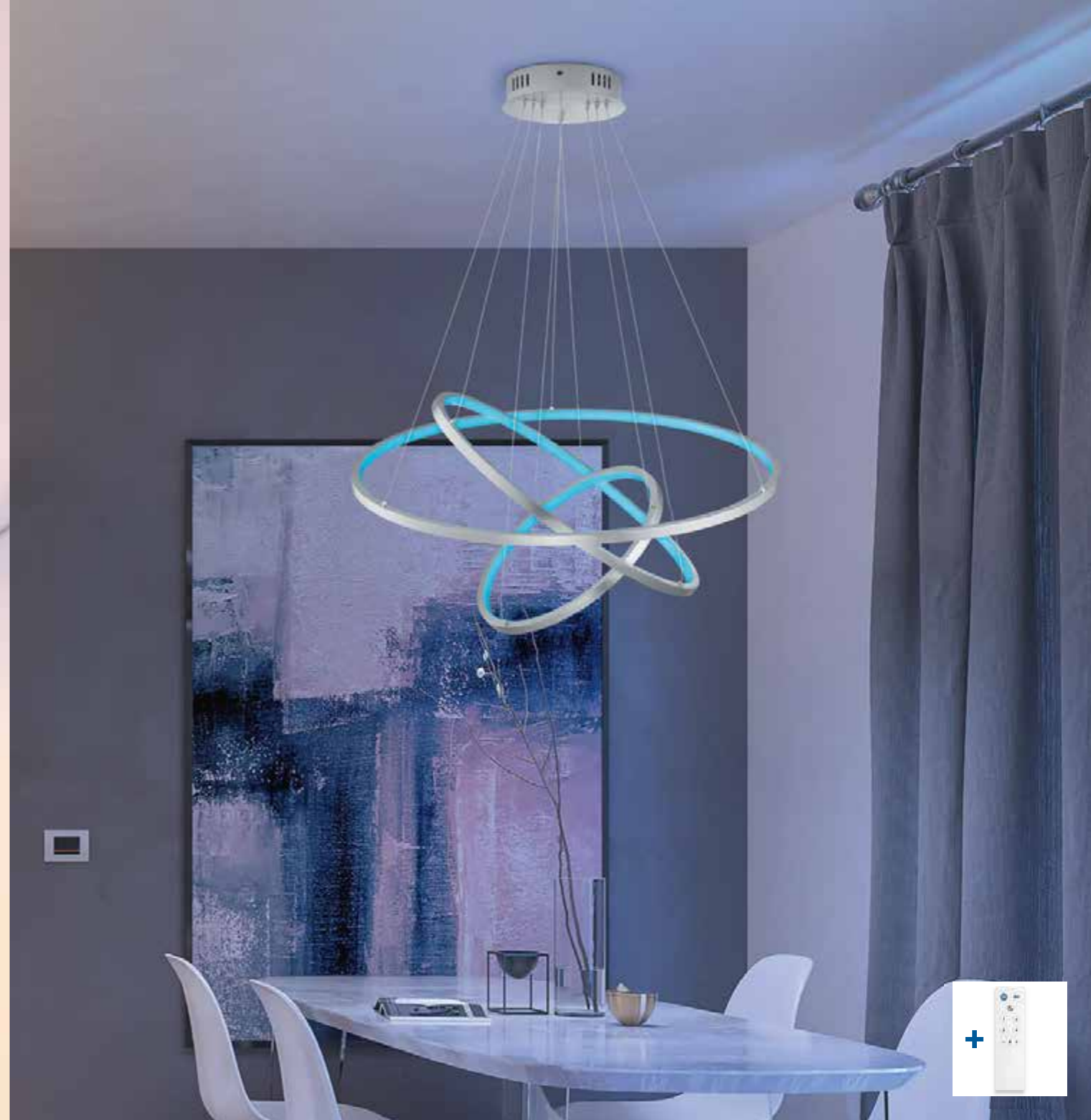
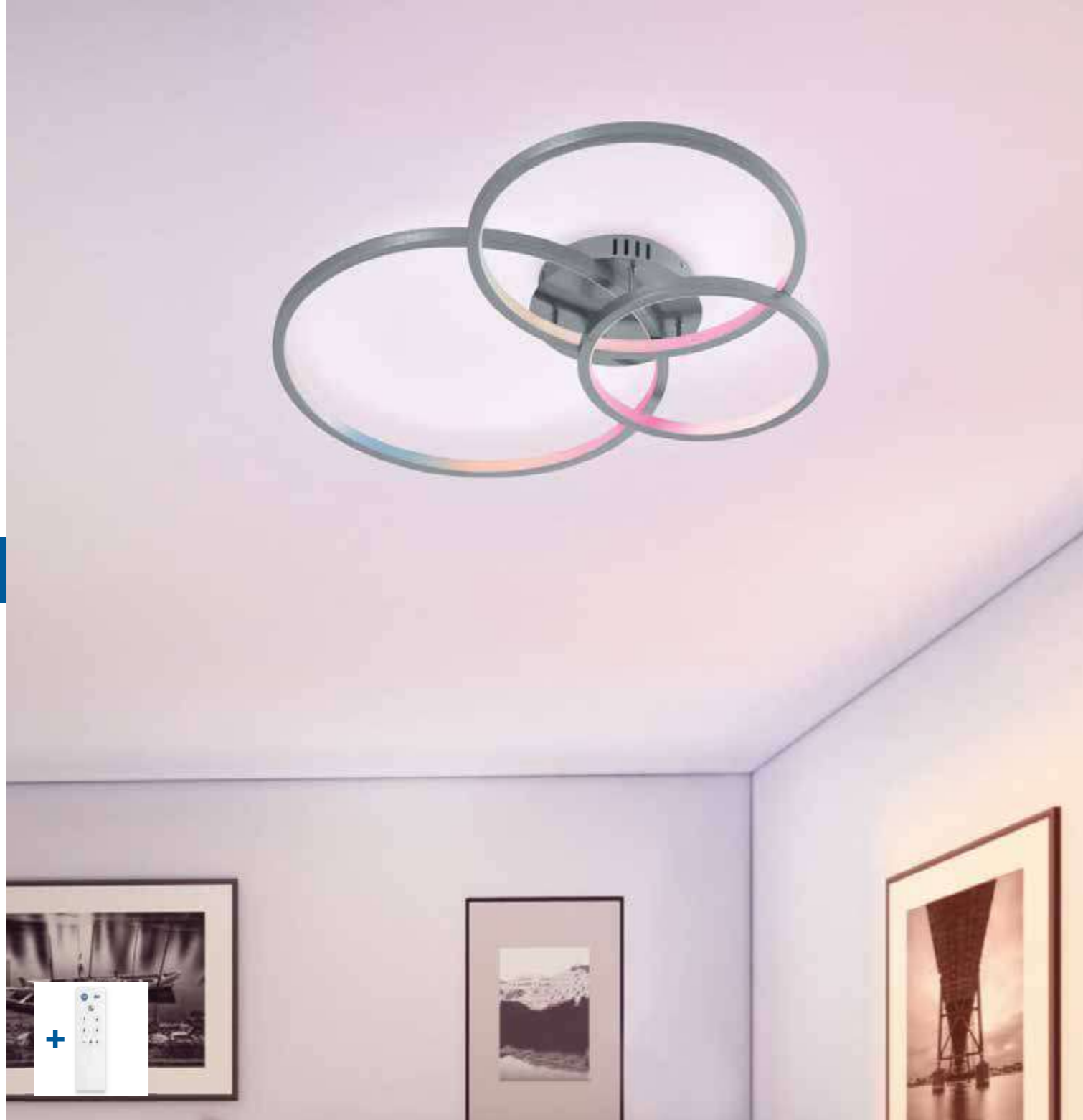

Deckenleuchte · Ceiling lamp
 ↔ 79 x 64 cm, ↑ 10,5 cm
 incl. RGBW-LED, 36,5 W
 4.200 lm, 3.000 - 6.000 K





652710307 | Nickel matt · nickel mat
 652710342 | Anthrazit · anthracite

AARON

Metall, Nickel matt oder Anthrazit · metal, nickel mat or anthracite ·
 metale, nickel mat ou antracite · metaal, nikkell mat of antraciet ·
 metal, níquel mate o antracita · metallo, nichel opaco o antracite ·
 metal, nichel mat sau antracit · metalli, harjattu teräs tai antrasiitti ·
 metal, nikiel mat lub antracyt

SMART LIGHTING

 RGBW Farbwechsler ·
 RGBW Colorchanging

 Lichtfarbe stufenlos einstellbar ·
 Light color infinitely variable



Pendelleuchte · Pendant
 Ø 80 cm, ↑ 150 cm
 incl. RGBW-LED, 78 W
 9.200 lm, 3.000 - 6.000 K



352710307 | Nickel matt · nickel mat
 352710342 | Anthrazit · anthracite

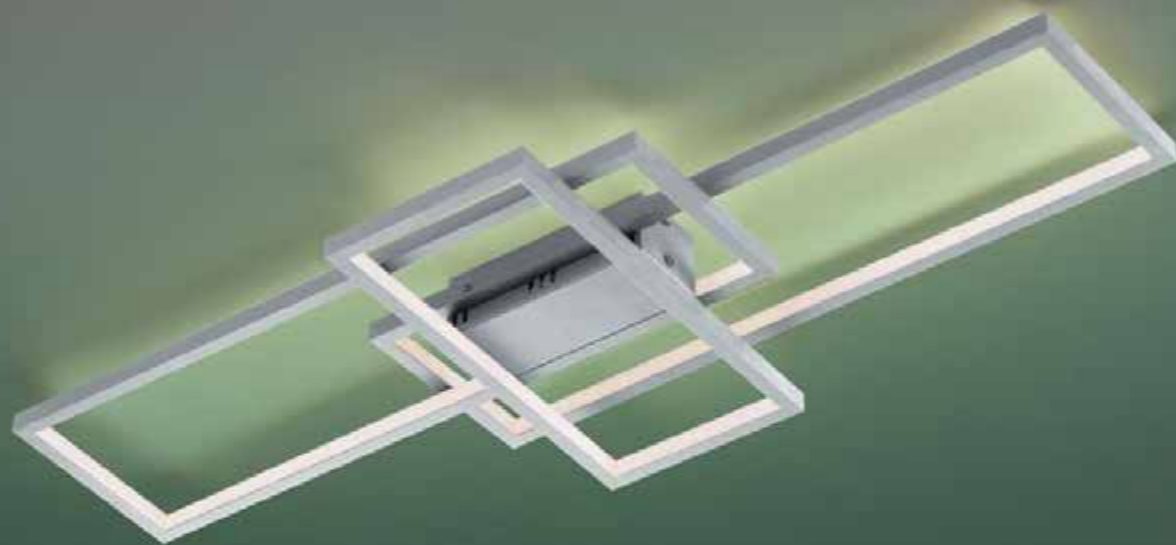
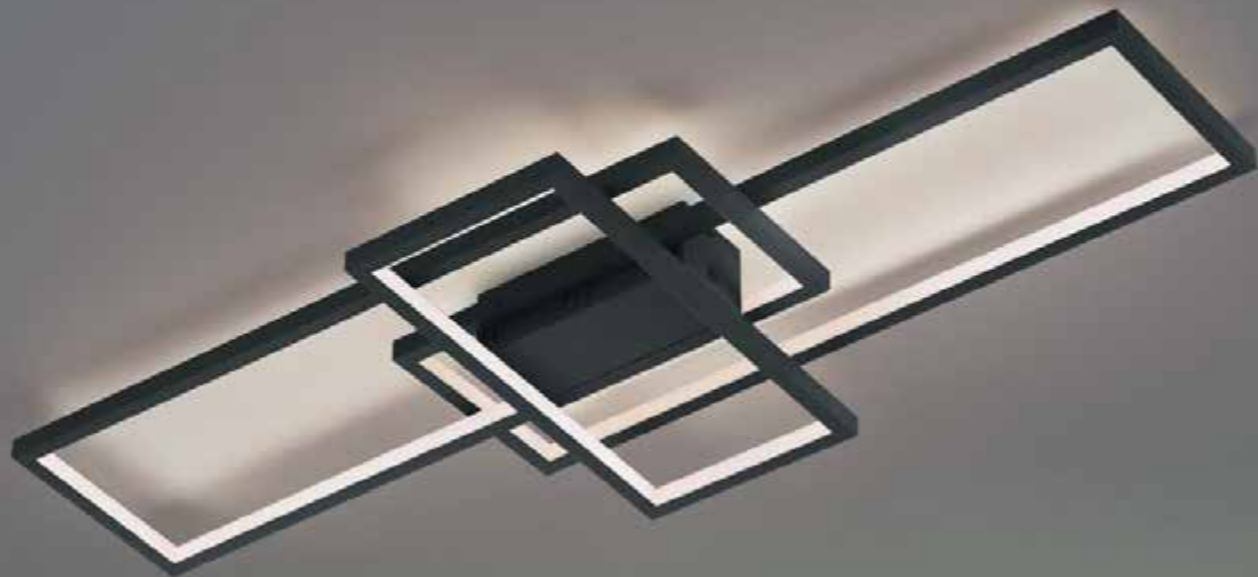

THIAGO

Metall, Nickel matt oder Anthrazit · metal, nickel mat or anthracite ·
metale, nickel mat ou antracite · metaal, nikkel mat of antraciet ·
metal, níquel mate o antracita · metallo, nichel opaco o antracite ·
metal, nichel mat sau antracit · metalli, harjattu teräs tai antrasiitti ·
metal, nikiel mat lub antracyt

SMART LIGHTING

 RGBW Farbwechsler ·
RGBW Colorchanging

 Lichtfarbe stufenlos einstellbar ·
Light color infinitely variable

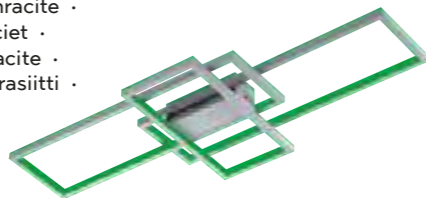

Deckenleuchte · Ceiling lamp
↔ 104 x 42 cm, ↑ 8,5 cm
incl. RGBW-LED, 36 W
3.000 lm, 3.000 - 6.000 K



652610307
652610342

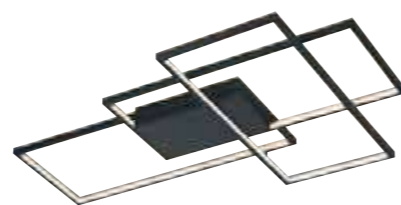

Deckenleuchte · Ceiling lamp
↔ 114 x 75 cm, ↑ 8,5 cm
incl. RGBW-LED, 39 W
4.500 lm, 3.000 - 6.000 K



652690307 | Nickel matt · nickel mat
652690342 | Anthrazit · anthracite



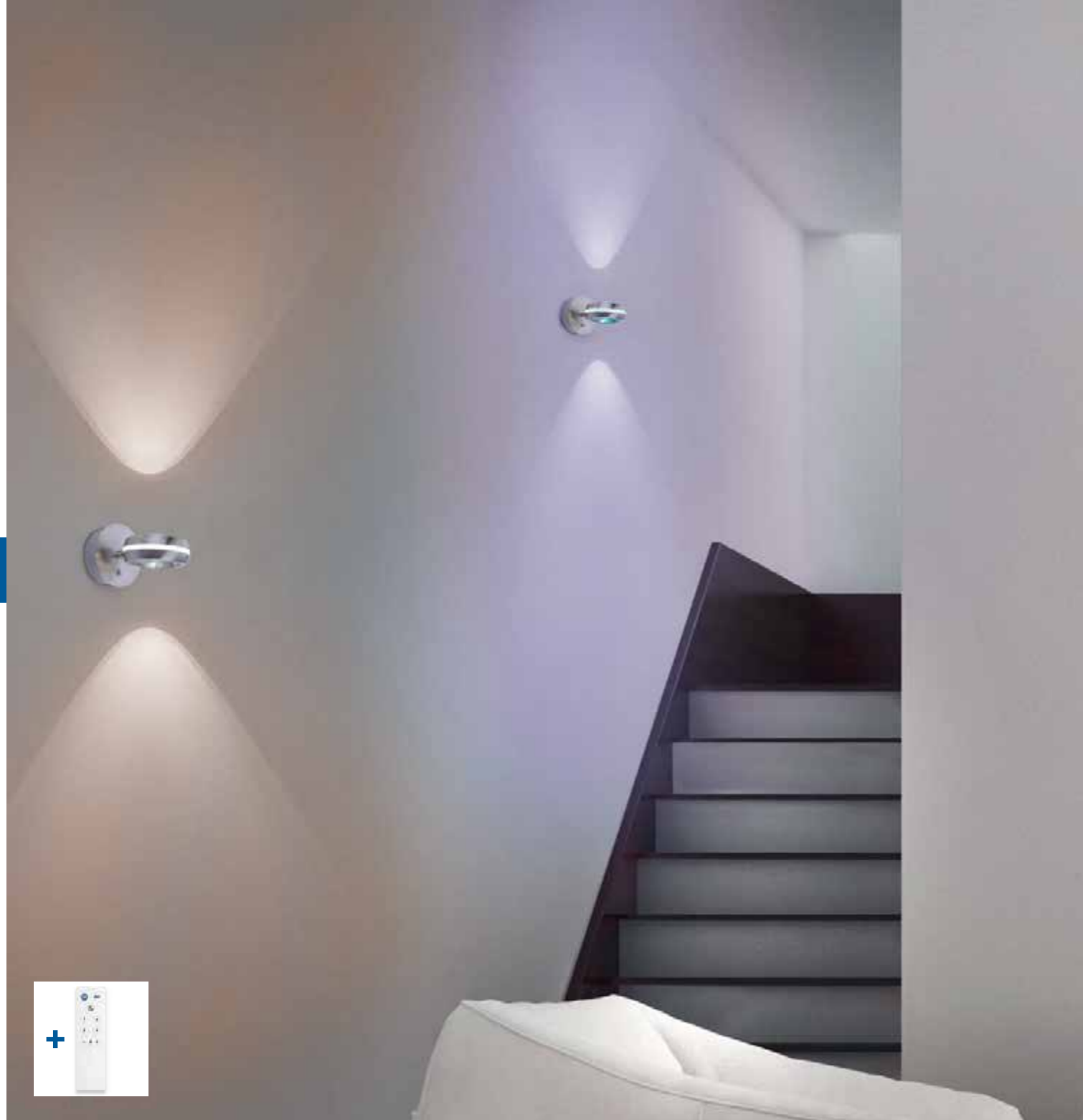

VISTA

Nickel matt · nickel mat ·
nickel mat · nikkel mat · níquel mate ·
nichel opaco · nichel mat · harjattu teräs · nikiel mat

SMART LIGHTING

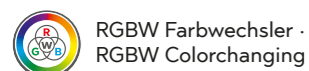

RGBW Farbwechsler ·
RGBW Colorchanging

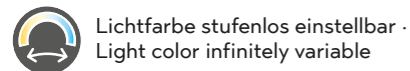

Lichtfarbe stufenlos einstellbar ·
Light color infinitely variable



Wandleuchte · Wall lamp
Ø 11 cm, ∇ 17,5 cm
incl. 2 x RGBW-LED, 3,8 W
2 x 380 lm, 3.000 - 5.000 K



255410207

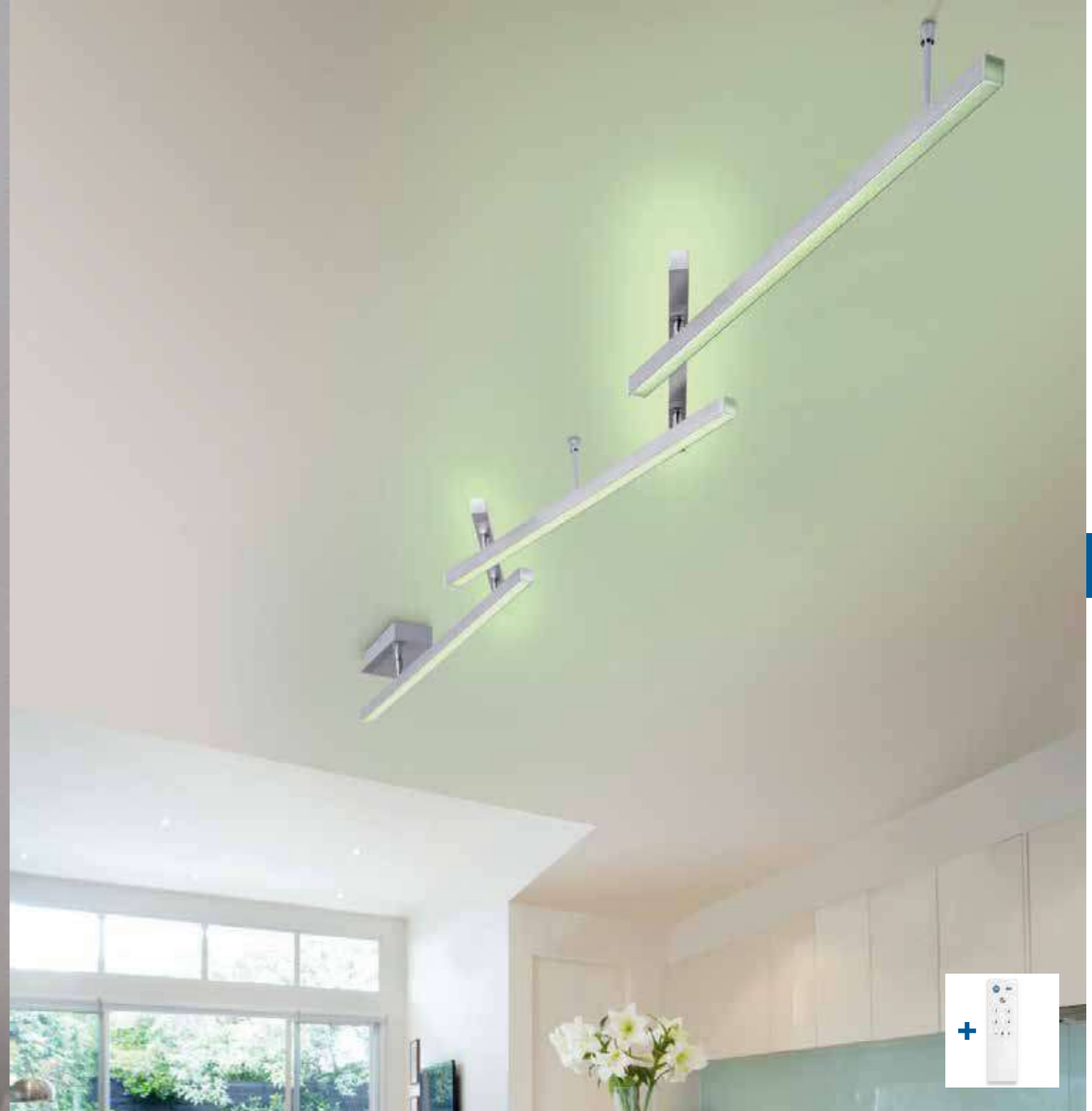

MELBY

Nickel matt, Acryl · nickel mat, acryl ·
nickel mat, acryl · nikkel mat, acryl · níquel mate, acrílico ·
nichel opaco, acrílico · nichel mat, acrílico · harjattu teräs, akryyli · nikiel mat, akryl

Direkte und indirekte Beleuchtung · up and down lighting ·
point lumineux en haut et en bas · lichtpunt boven en onder · luz de arriba y abajo ·
luce su e giù · sus și în jos lumina · ylös ja alas valoa · w górę i w dół światło

SMART LIGHTING



RGBW Farbwechsler ·
RGBW Colorchanging

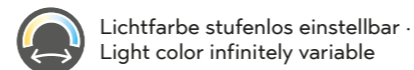

Lichtfarbe stufenlos einstellbar ·
Light color infinitely variable

Deckenleuchte · Ceiling lamp
↔ max. 242 x 10 cm, ↓ 12 cm
incl. RGBW-LED, 23 W
max. 2.200 lm, 3.000 - 5.000 K



651210507

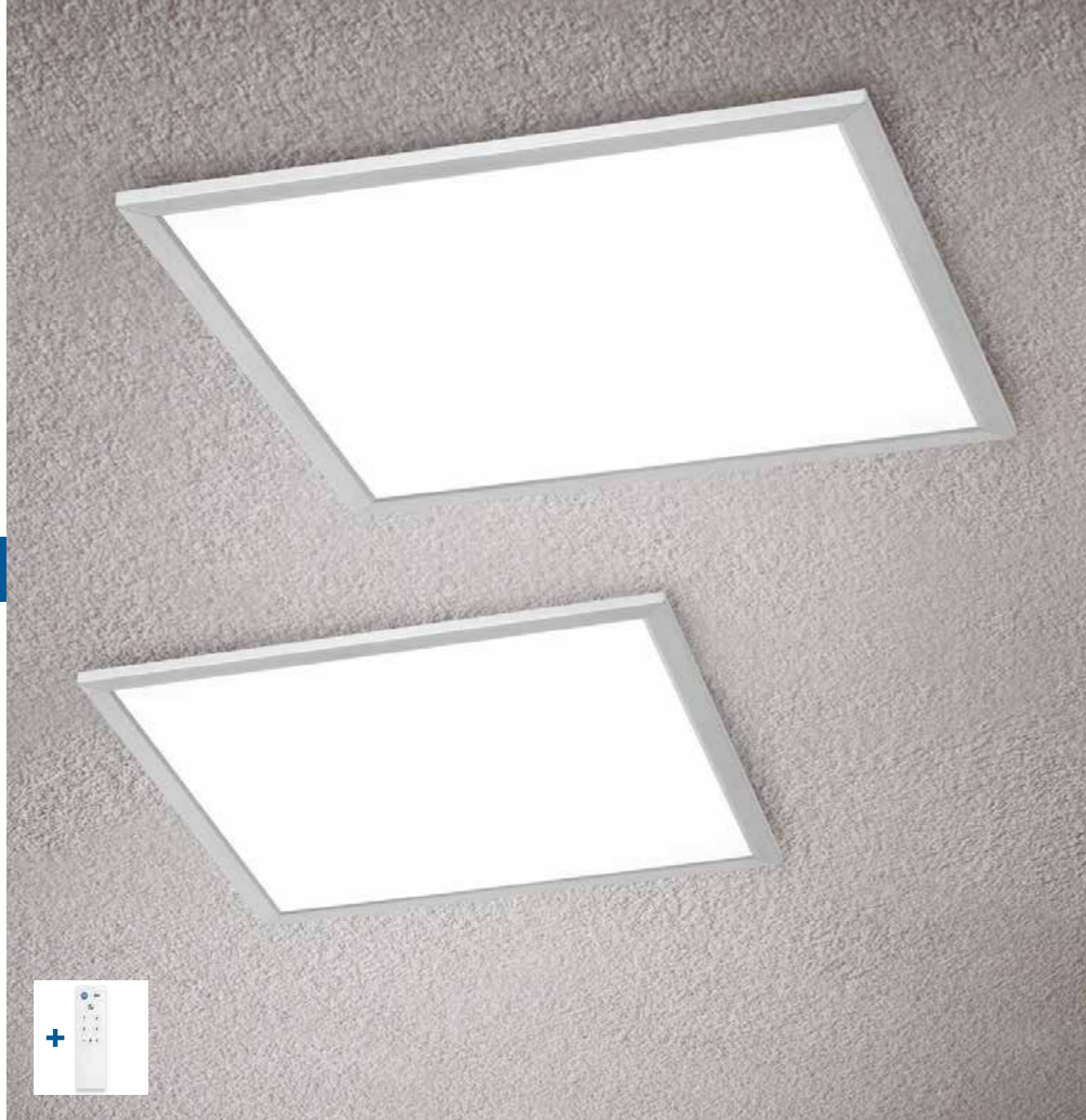

GRIFFIN

Nickel matt, Acryl · nickel mat, acryl ·
 nickel mat, acryl · nikkelt mat, acryl · níquel mate, acrílico · nichel opaco, acrílico ·
 nichel mat, acrílic harjattu teräs, akryyli · nikiel mat, akryl

SMART LIGHTING

 RGBW Farbwechsler ·
 RGBW Colorchanging

 Lichtfarbe stufenlos einstellbar ·
 Light color infinitely variable



Deckenleuchte · Ceiling lamp
 ↔ 39,5 x 39,5 cm, ↓ 5 cm
 incl. SMD-LED, 20 W
 2.300 lm, 3.000 - 5.500 K



657414007



Deckenleuchte · Ceiling lamp
 ↔ 59,5 x 59,5 cm, ↓ 5 cm
 incl. SMD-LED, 36 W
 4.200 lm, 3.000 - 5.500 K



657416007



Deckenleuchte · Ceiling lamp
 ↔ 109,5 x 29,5 cm, ↓ 5 cm
 incl. SMD-LED, 37 W
 4.300 lm, 3.000 - 5.500 K



657411107

CHARLY

Acryl, weiß · acryl, white ·
acryl, blanc · acryl, wit · acrílico, blanco · acrilico, bianco ·
acrilic, alb · akryyli, valkoinen · akryl, biały

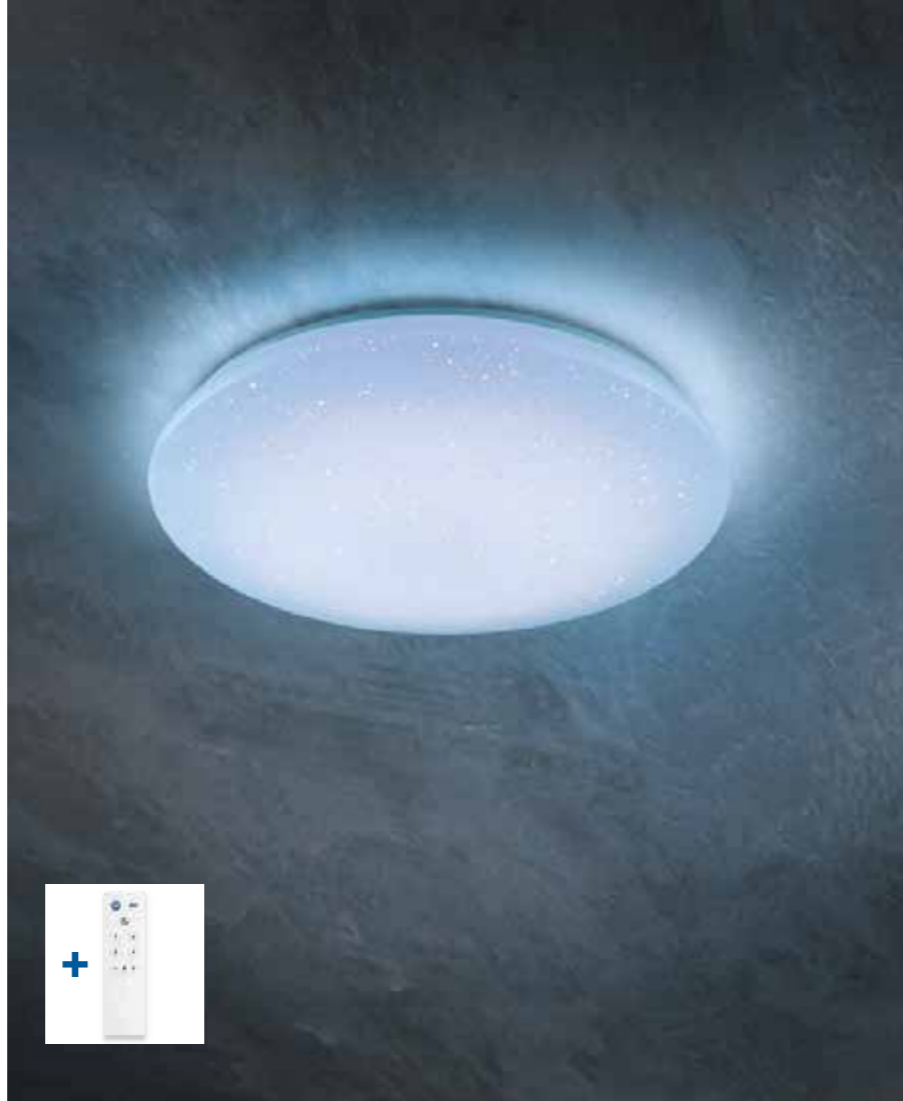

Deckenleuchte · Ceiling lamp

Ø 50 cm, ↑ 12 cm
incl. RGBW-LED, 27 W
max. 3.100 lm, 3.000 - 5.500 K



656010100



SMART LIGHTING

 RGBW Farbwechsler ·
RGBW Colorchanging

 Lichtfarbe stufenlos einstellbar ·
Light color infinitely variable

NALIDA

Acryl, weiß · acryl, white ·
acryl, blanc · acryl, wit · acrílico, blanco · acrilico, bianco ·
acrilic, alb · akryyli, valkoinen · akryl, biały

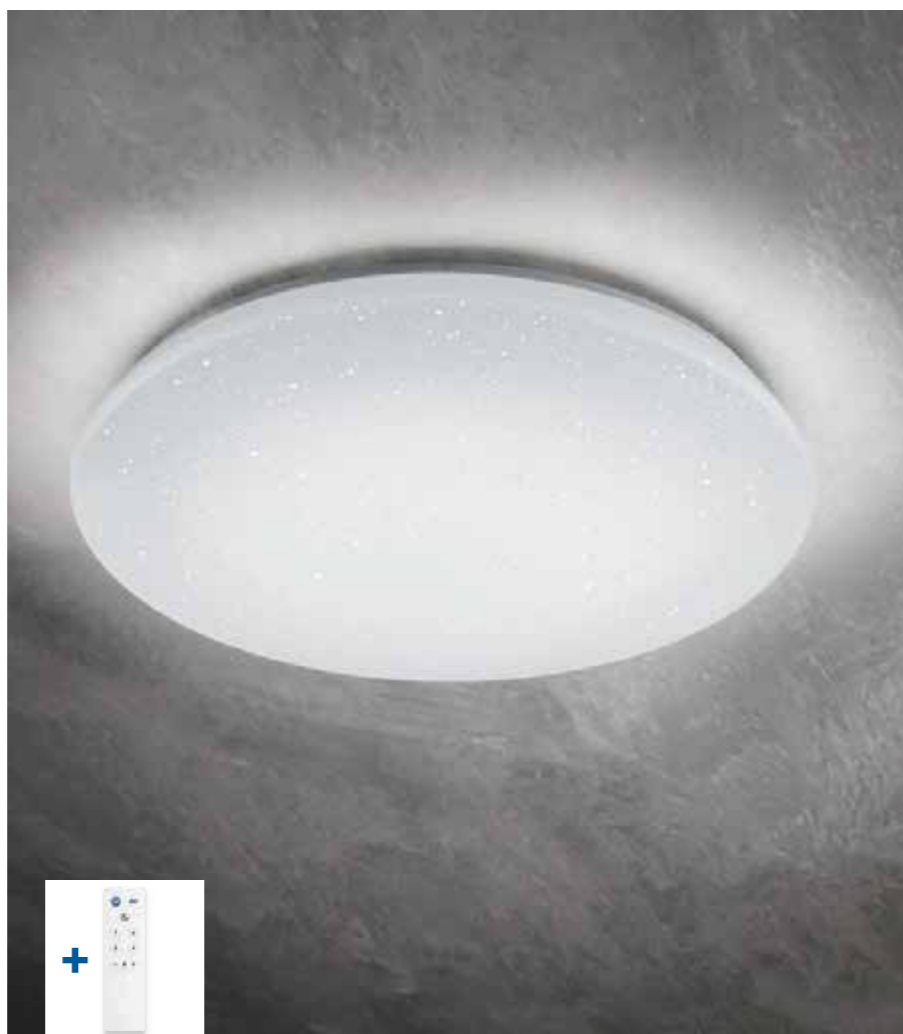

Deckenleuchte · Ceiling lamp

Ø 74 cm, ↑ 10 cm
incl. RGBW-LED, 40 W
max. 4.650 lm, 3.000 - 5.500 K



656090100



DIAMO

Stoff weiß · fabric white ·
tissu blanc · textiel wit · tela blanco · tessuto bianco ·
textil alb · tekstiili valkoinen · tkanina biały

SMART LIGHTING

 RGBW Farbwechsler ·
RGBW Colorchanging

 Lichtfarbe stufenlos einstellbar ·
Light color infinitely variable



Deckenleuchte · Ceiling lamp
Ø 60 cm, ↑ 10 cm
incl. RGBW-LED, 36 W
max. 3.400 lm, 3.000 - 5.000 K



651914001



Deckenleuchte · Ceiling lamp
Ø 75 cm, ↑ 10 cm
incl. 1 x RGBW-LED, 47 W
max. 5.500 lm, 3.000 - 5.000 K



651915501

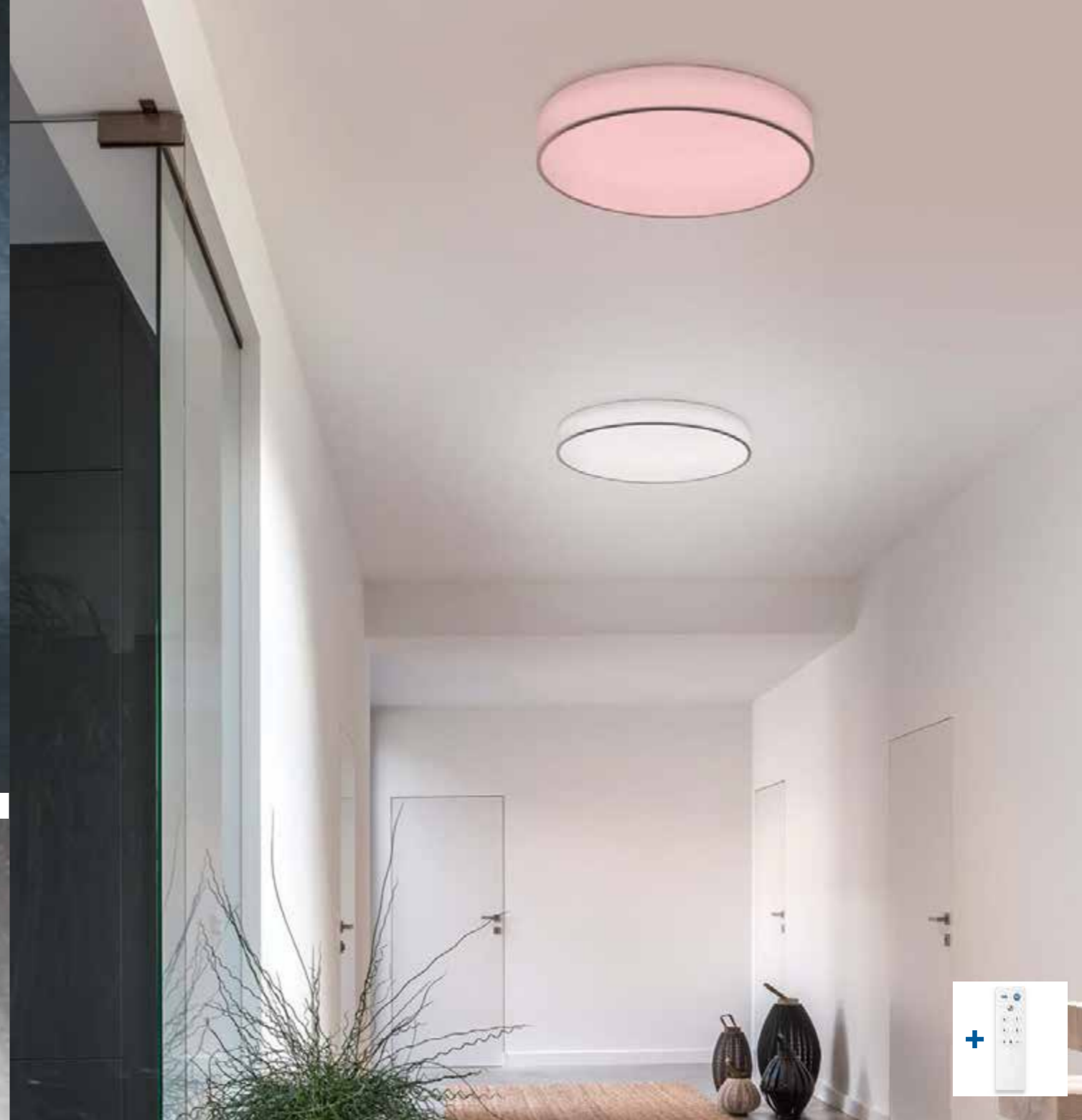

Leuchtenfamilien & Kombinationen

Families & coordinates
Familles & coordonnés
Families & combinaties
Familias & coordinados
Famiglie & coordinati
Famillii & Coordonate
Tuoteperheet & yhdistettävät tuotteet
Rodzinne orawy & kombinacje





MARNIE

Metall · metal ·
metale · metaal · metal · metallo · metal · metalli · metal

05 | Aluminium gebürstet · brushed aluminium

65 | Coffee · coffee

80 | Schwarz-Gold · black-gold



Deckenleuchte · Ceiling lamp
Ø 55 cm, ↑ 21 cm
incl. SMD-LED, 58 W
6.800 lm, 3.000 K



644110105
644110165
644110180



Pendelleuchte · Pendant
Ø 65 cm, ↑ 150 cm
incl. SMD-LED, 68 W
8.000 lm, 3.000 K



344110105
344110165
344110180







SEQUENCE



Metall, Messing matt, Schwarz matt · metal, brass mat, black mat ·
 métal, laiton mat, noir mat · metaal, messing mat, mat zwart ·
 metal, bronze mate, estera negra · metallo, ottone satinato, nero opaco ·
 metal, bronz mat, negru mat · metalli, mattamessinki, mattamusta ·
 metal, mosiądz mat, czarny mat

 Lichtfarbe einstellbar ·
 Adjustable light color





Wandleuchte · Wall lamp
 ↑ 47 cm, ↔ 13,5 cm, ↗ 20,5 cm
 incl. SMD-LED, 22 W
 2.800 lm, 2.300 + 3.000 + 4.000 K
 
241810208





Deckenleuchte · Ceiling lamp
 ↔ 90 x 14,5 cm, ↓ 20,5 cm
 incl. SMD-LED, 41 W
 5.000 lm, 2.300 + 3.000 + 4.000 K
 
641810208





Tischleuchte · Table lamp
 ↓ 48,5 cm, Ø 16 cm
 incl. SMD-LED, 20,5 W
 2.600 lm, 2.300 + 3.000 + 4.000 K
  
541810208



Stehleuchte · Floor lamp
 ↓ 150 cm, Ø 23 cm
 incl. SMD-LED, 32 W
 4.000 lm, 2.300 + 3.000 + 4.000 K
  
441810208



Pendelleuchte · Pendant
 ↓ 150 cm, ↔ 105 x 16 cm
 incl. SMD-LED, 45 W
 5.600 lm, 2.300 + 3.000 + 4.000 K
 
341810208



SEQUENCE

Metall, Aluminium gebürstet, Schwarz matt · metal, brushed aluminium, black mat ·
 métal, aluminium balayé, noir mat · metaal, geborsteld aluminium, mat zwart ·
 metal, aluminio pulido, estera negra · metallo, alluminio spazzolato, nero opaco ·
 metal, aluminiu lucios, negru mat · metalli, harjattu alumiini, mattamusta ·
 metal, aluminium szczotkowane, czarny mat

 Lichtfarbe einstellbar ·
 Adjustable light color



2.300 K

3.000 K

4.000 K



Wandleuchte · Wall lamp
 ↓ 47 cm, ↔ 13,5 cm, ↗ 20,5 cm
 incl. SMD-LED, 22 W
 2.800 lm, 2.300 + 3.000 + 4.000 K



241810205



Deckenleuchte · Ceiling lamp
 ↔ 90 x 14,5 cm, ↓ 20,5 cm
 incl. SMD-LED, 41 W
 5.000 lm, 2.300 + 3.000 + 4.000 K



641810205



Tischleuchte · Table lamp
 ↓ 48,5 cm, Ø 16 cm
 incl. SMD-LED, 20,5 W
 2.600 lm, 2.300 + 3.000 + 4.000 K



541810205



Stehleuchte · Floor lamp
 ↓ 150 cm, Ø 23 cm
 incl. SMD-LED, 32 W
 4.000 lm, 2.300 + 3.000 + 4.000 K



441810205



Pendelleuchte · Pendant
 ↓ 150 cm, ↔ 105 x 16 cm
 incl. SMD-LED, 45 W
 5.600 lm, 2.300 + 3.000 + 4.000 K



341810205



2.700 K 3.200 K 4.000 K

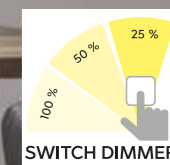
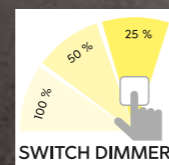

Stehleuchte · Floor lamp
↑ 133 cm, Ø 23 cm, ↗ 41 cm
incl. SMD-LED, 6,5 W
650 lm, 2.700 + 3.200 + 4.000 K



- 426510104
- 426510107
- 426510108
- 426510142



Pendelleuchte · Pendant
↑ 95 - 150 cm, Ø 14 cm
incl. SMD-LED, 9 W
1.050 lm, 3.000 K



- 326510107
- 326510108
- 326510142



Pendelleuchte · Pendant
↑ 95 - 150 cm, ↔ 55 x 14 cm
incl. 2 x SMD-LED, 9 W
2 x 1.050 lm, 3.000 K



- 326510207
- 326510208
- 326510242

FRANKLIN

Metall · metal ·
metale · metaal · metal ·
metallo · metal · metalli · metal

-  **04** | Altmessing · old brass
-  **07** | Nickel matt · nickel mat
-  **08** | Messing matt · brass mat
-  **42** | Anthrazit · anthracite



Pendelleuchte · Pendant
↑ 95 - 150 cm, ↔ 85 x 14 cm
incl. 3 x SMD-LED, 9 W
3 x 1.050 lm, 3.000 K



- 326510307
- 326510308
- 326510342



FRANKLIN

Metall · metal · metals · metaal · metal · metallo · metal · metalli · metal

-  **04** | Altmessing · old brass
-  **07** | Nickel matt · nickel mat
-  **08** | Messing matt · brass mat
-  **42** | Anthrazit · anthracite



Deckenleuchte · Ceiling lamp
 Ø 35 cm, ↑ 13 cm
 incl. 3 x SMD-LED, 8,5 W
 3 x 1.000 lm, 3.000 K



626510304
 626510307
 626510308
 626510342



Tischleuchte · Table lamp
 ↑ 25 cm, Ø 14 cm
 incl. SMD-LED, 6 W
 700 lm, 3.000 K



526510104
 526510107
 526510108
 526510142



Stehleuchte · Floor lamp
 ↑ 181 cm, Ø 35,2 cm, ↗ 41 cm
 incl. SMD-LED, 35 W, 4.100 lm
 incl. SMD-LED, 6,5 W, 650 lm
 2.700 + 3.200 + 4.000 K



426510204
 426510207
 426510208
 426510242

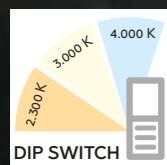

DIP SWITCH

Lichtfarben direkt an der Leuchte einstellbar · Colours directly adjustable at the lamp · Les couleurs de la lumière peuvent être réglées directement sur le luminaire · Lichtkleuren direct instelbaar op de lamp · Tonalidades de luz ajustables directamente en la lámpara · Colori della luce regolabili direttamente sulla lampada · Colori ale luminii reglabile direct de la bec · Valon väri asetettävissä suoraan valaisimesta · Barwy światła można ustawić bezpośrednio na oprawie



Deckenleuchte · Ceiling lamp
 Ø 59 cm, ↓ 14 cm
 incl. SMD-LED, 58 W
 7.000 lm, 2.300 + 3.000 + 4.000 K



626210107
 626210132



Pendelleuchte · Pendant
 Ø 60 cm, ↓ 150 cm
 incl. SMD-LED, 60 W
 7.200 lm, 2.300 + 3.000 + 4.000 K



326210107
 326210132

NURIA

Metall, Acryl · metal, acryl ·
 metale, acryl · metaal, acryl · metal, acrílico ·
 metallo, acrilico · metal, acrilic · metalli, akryyli · metal, akryl



Lichtfarbe einstellbar ·
 Adjustable light color



07 | Nickel matt · nickel mat

32 | Schwarz matt · black mat



Stehleuchte · Floor lamp
 ↓ 150 cm, Ø 35 cm
 incl. SMD-LED, 34 W
 4.000 lm, 2.300 + 3.000 + 4.000 K



426219107
 426219132



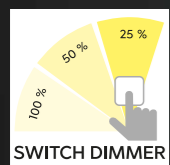

Pendelleuchte · Pendant
 Ø 62 cm, ↑ 150 cm
 incl. SMD-LED, 42 W
 5.600 lm, 3.000 K



321210107
 321210108



Deckenleuchte · Ceiling lamp
 Ø 41 cm, ↑ 14 cm
 incl. SMD-LED, 20 W
 2.500 lm, 3.000 K



621210107
 621210108



Deckenleuchte · Ceiling lamp
 Ø 62 cm, ↑ 18 cm
 incl. SMD-LED, 42 W
 5.600 lm, 3.000 K



621290107
 621290108

CHARIVARI

Nickel matt oder Messing matt · nickel mat or brass mat ·
 nickel mat ou laiton mat · nikkell mat of messing mat ·
 níquel mate o bronze mate · nichel opaco o ottone satinato ·
 nichel mat sau bronz mat · harjattu teräs tai mattamessinki ·
 nikiel mat lub mosiądz mat



07 | Nickel matt · nickel mat

08 | Messing matt · brass mat



Tischleuchte · Table lamp
 ↑ 50 cm, Ø 41 cm
 incl. SMD-LED, 26 W
 2.500 lm, 3.000 K



521210107
 521210108



Stehleuchte · Floor lamp
 ↑ 175 cm, Ø 52 cm
 incl. SMD-LED, 31 W
 4.100 lm, 3.000 K



421210107
 421210108

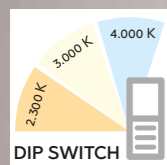

BLAZE

Metall, Aluminium gebürstet oder Messing matt, Schwarz matt · metal, brushed aluminium or brass mat, black mat · métal, aluminium balayé ou laiton mat, noir mat · metaal, geborsteld aluminium of messing mat, mat zwart · metal, aluminio pulido o bronce mate, estera negra · metallo, alluminio spazzolato o ottone satinato, nero opaco · metal, aluminiu lucios sau bronz mat, negru mat · metalli, harjattu alumiini tai mattamessinki, mattamusta · metal, aluminium szczotkowane lub mosiądz mat, czarny mat

 Lichtfarbe einstellbar · Adjustable light color

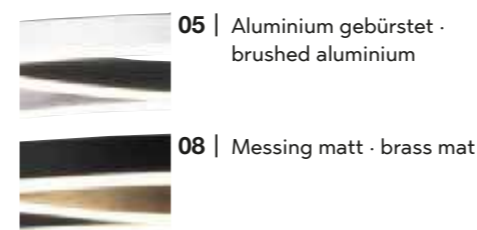

Deckenleuchte · Ceiling lamp
↔ 107,5 x 18 cm, ↓ 7 cm
incl. SMD-LED, 35 W
4.300 lm, 2.300 + 3.000 + 4.000 K

Pendelleuchte · Pendant
↓ 150 cm, ↔ 107,5 x 15,5 cm
incl. SMD-LED, 35 W
4.300 lm, 2.300 + 3.000 + 4.000 K

Tischleuchte · Table lamp
↓ 48 cm, ↔ 13,5 cm
incl. SMD-LED, 8 W
900 lm, 2.300 + 3.000 + 4.000 K

Stehleuchte · Floor lamp
↓ 138 cm, ↔ 20,5 cm
incl. SMD-LED, 28 W
3.250 lm, 2.300 + 3.000 + 4.000 K



641210305
641210308

341210305
341210308

541210205
541210208

441210305
441210308

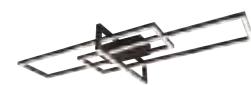

Deckenleuchte · Ceiling lamp
 ↔ 100 x 40 cm, ↑ 11,5 cm
 incl. SMD-LED, 34 W
 3.900 lm, 3.000 K
 (31 = 4.100 lm, 4.000 K)



620310307
 620310308
 620310331
 620310332



Pendelleuchte · Pendant
 ↓ max. 150 cm, ↔ 110 x 40 cm
 incl. SMD-LED, 34 W
 4.200 lm, 3.000 K
 (31 = 4.400 lm, 4.000 K)



320310307
 320310308
 320310331
 320310332



- 07 | Nickel matt · nickel mat
- 08 | Messing matt / Schwarz matt
brass matt / black mat
- 31 | Weiß matt · white mat
- 32 | Schwarz matt · black mat



SALINAS

Metall · metal ·
 metale · metaal · metal ·
 metallo · metal · metalli · metal

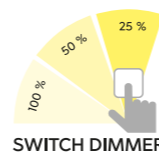

SWITCH DIMMER

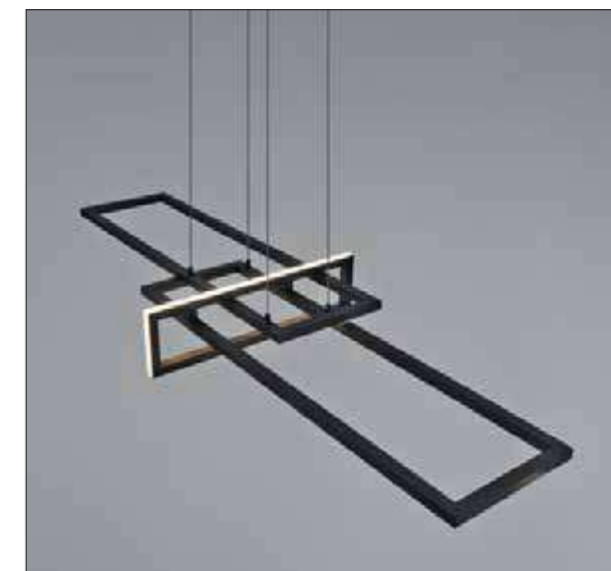
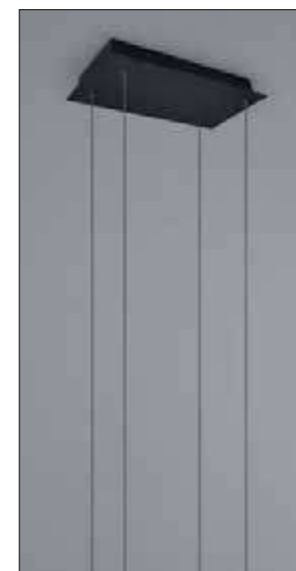

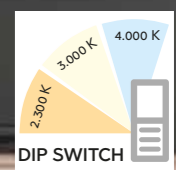

EDGE

Metall, Schwarz matt / Messing matt · metal, black mat / brass mat ·
 metale, noir mat / laiton mat · metaal, mat zwart / messing mat · metal, estera negra / bronce mate ·
 metallo, nero opaco / ottone satinato · metal, negru mat / bronz mat · metalli, mattamusta / mattamessinki ·
 metal, czarny mat / mosiądz mat

 Lichtfarbe einstellbar ·
 Adjustable light color



Pendelleuchte · Pendant
 ↔ 118,5 x 19,3 cm, ↑ 150 cm
 incl. SMD-LED, 35 W
 4.100 lm, 2.300 + 3.000 + 4.000 K



326810132



Tischleuchte · Table lamp
 ↑ 44 cm, ↔ 21 x 17,5 cm
 incl. SMD-LED, 9 W
 950 lm, 2.300 + 3.000 + 4.000 K



526810132



Stehleuchte · Floor lamp
 ↑ 124 cm, ↔ 21 x 17,5 cm
 incl. SMD-LED, 26 W
 2.950 lm, 2.300 + 3.000 + 4.000 K



426810132

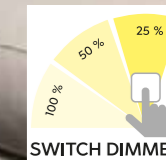
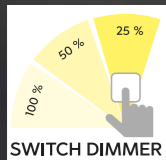

FRANCIS

Metall, Aluminium gebürstet, Weiß matt oder Anthrazit · metal, brushed aluminium, white mat or anthracite ·
 metale, aluminium balayé, blanc mat ou antracite · metaal, geborsteld aluminium, wit mat of antraciet ·
 metal, aluminio pulido, estera blanca o antracita · metallo, alluminio spazzolato, bianco opaco o antracite ·
 metal, aluminiu lucios, alb mat sau antracit · metalli, harjattu alumiini, mattavalkoinen tai antrasiitti ·
 metal, aluminium szczotkowane, biały mat lub antracyt

-  05 | Aluminium gebürstet · brushed aluminium
-  31 | Weiß matt · white mat
-  42 | Anthrazit · anthracite



Deckenleuchte · Ceiling lamp
 ↔ 54 x 52 cm, ↑ 19,5 cm
 incl. SMD-LED, 40 W
 4.650 lm, 3.000 K



671310105
 671310131
 671310142



Pendelleuchte · Pendant
 ↔ 72 x 68 cm, ↑ 150 cm
 incl. SMD-LED, 48 W
 5.600 lm, 3.000 K



371310105
 371310131
 371310142

OAKLAND

Metall, Nickel matt oder Anthrazit · metal, nickel mat or anthracite ·
 metale, nickel mat ou antracite · metaal, nikkel mat of antraciet · metal, níquel mate o antracita ·
 metallo, nichel opaco o antracite · metal, nichel mat sau antracit · metalli, harjattu teräs tai antrasiitti ·
 metal, nikiel mat lub antracyt



07 | Nickel matt · nickel mat



42 | Anthrazit · anthracite



Deckenleuchte · Ceiling lamp
 Ø 53 cm, ↑ 23,5 cm
 incl. SMD-LED, 40 W
 5.200 lm, 3.000 K



621710107
 621710142



Pendelleuchte · Pendant
 Ø 71 cm, ↑ 150 cm
 incl. SMD-LED, 52 W
 6.200 lm, 3.000 K



321710107
 321710142

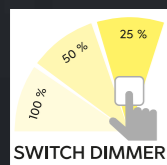

CARRERA

Metall, Acryl · metal, acryl ·
 metale, acryl · metaal, acryl · metal, acrílico ·
 metallo, acrilico · metal, acrilic · metalli, akryyli · metal, akryl



05 | Aluminium gebürstet · brushed aluminium



32 | Schwarz matt · black mat



Deckenleuchte · Ceiling lamp
 Ø 45 cm, ↑ 22 cm
 incl. SMD-LED, 38 W
 4.400 lm, 3.000 K



625010105



Pendelleuchte · Pendant
 ↑ 150 cm, Ø 55 cm
 incl. SMD-LED, 38 W
 4.400 lm, 3.000 K



325010105
 325010132



SYDNEY

Chrom, Acryl · chrome, acryl ·
 chrome, acryl · chroom, acryl · cromo, acrílico ·
 cromo, acrilico · crom, acrilic · kromi, akryyli · chrom, akryl



Deckenleuchte · Ceiling lamp
 ↔ 103 x 18 cm, ↑ 27 cm
 incl. SMD-LED, 18 W
 2.000 lm, 3.000 K



672910106



Tischleuchte · Table lamp
 ↑ 63 cm, Ø 20 cm
 incl. SMD-LED, 12 W
 1.300 lm, 3.000 K



572910106



Stehleuchte · Floor lamp
 ↑ 162 cm, Ø 25 cm
 incl. SMD-LED, 22 W
 2.500 lm, 3.000 K



472910106



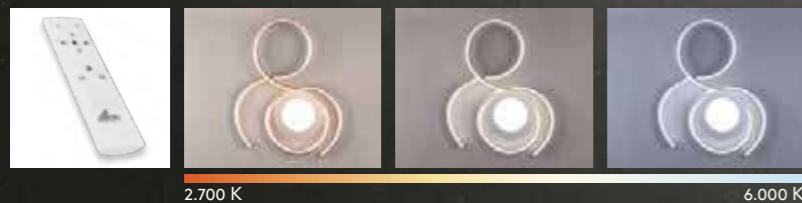

2.700 K

6.000 K



JIVE

Metall, Acryl · metal, acryl ·
metale, acryl · metaal, acryl · metal, acrílico ·
metallo, acrílico · metal, acrílic · metalli, akryyli ·
metal, akryl



Lichtfarbe stufenlos einstellbar ·
Light color infinitely variable



Integrierter Dimmer ·
Integrated dimmer

07 | Nickel matt · nickel mat

31 | Weiß matt · white mat

32 | Schwarz matt · black mat



Deckenleuchte · Ceiling lamp
↔ 50 x 45,5 cm, ↑ 7,6 cm
incl. SMD-LED, 36 W
4.300 lm, 2.700 - 6.000 K



623410207
623410231
623410232



Deckenleuchte · Ceiling lamp
↔ 80 x 73 cm, ↑ 7,6 cm
incl. SMD-LED, 48 W
5.600 lm, 2.700 - 6.000 K



623419207
623419231
623419232



Stehleuchte · Floor lamp
↑ 118 cm, ↔ 32 x 24 cm
incl. SMD-LED, 23 W
2.700 lm, 2.700 + 4.000 + 6.000 K



423410107
423410131
423410132

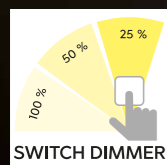

Deckenleuchte · Ceiling lamp
↔ 53 x 59 cm, ↑ 5,5 cm
incl. SMD-LED, 49 W
5.800 lm, 3.000 K



622610531
622610532



Deckenleuchte · Ceiling lamp
↔ 97 x 34,3 cm, ↑ 5,5 cm
incl. SMD-LED, 37 W
4.800 lm, 3.000 K



622610431
622610432



Pendelleuchte · Pendant
↔ 110 x 30 cm, ↑ 150 cm
incl. SMD-LED, 37 W
4.600 lm, 3.000 K



322610431
322610432

RONDO

Metall, Weiß matt oder Schwarz matt · metal, white mat or black mat ·
metale, blanc mat ou noir mat · metaal, wit mat of mat zwart ·
metal, estera blanca o estera negra · metallo, bianco opaco o nero opaco ·
metal, alb mat sau negru mat · metalli, mattavalkoinen tai mattamusta ·
metal, biały mat lub czarny mat



31 | Weiß matt · white mat



32 | Schwarz matt · black mat



Tischleuchte · Table lamp
↑ 45 cm, ↔ 20,7 cm
incl. SMD-LED, 17 W
1.900 lm, 3.000 K



522610331
522610332



Stehleuchte · Floor lamp
↑ 115 cm, ↔ 47 cm
incl. SMD-LED, 36 W
4.700 lm, 3.000 K



422610531
422610532



Dimmbar ·
Dimmable

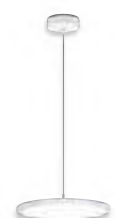

Pendelleuchte · Pendant
↓ 150 cm, Ø 40 cm
incl. SMD-LED, 29 W
3.750 lm, 4.000 K



340910131



Pendelleuchte · Pendant
↓ 150 cm, ↔ 90 x 17 cm
incl. 3 x SMD-LED, 10 W
3 x 1.250 lm, 4.000 K



340910331



Deckenleuchte · Ceiling lamp
Ø 40 cm, ↓ 12 cm
incl. SMD-LED, 29 W
3.750 lm, 4.000 K



640910131



Kippbar ·
Tilttable

TRAY

Metall, weiß matt oder schwarz matt · metal, white mat or black mat ·
metale, blanc mat ou noir mat · metaal, wit mat of mat zwart ·
metal, estera blanca o estera negra · metallo, bianco
opaco o nero opaco · metal, alb mat sau negru mat ·
metalli, valkoinen matto tai musta matto · metal, biały
mat lub czarny mat · metal, beyaz mat veya siyah mat



31 | Weiß matt · white mat

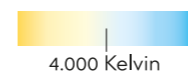

32 | Schwarz matt · black mat

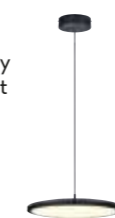

Pendelleuchte · Pendant
↓ 150 cm, Ø 40 cm
incl. SMD-LED, 29 W
3.550 lm, 3.000 K



340910132



Pendelleuchte · Pendant
↓ 150 cm, ↔ 90 x 17 cm
incl. 3 x SMD-LED, 10 W
3 x 1.200 lm, 3.000 K



340910332



Deckenleuchte · Ceiling lamp
Ø 40 cm, ↓ 12 cm
incl. SMD-LED, 29 W
3.550 lm, 3.000 K



640910132



Deckenleuchte · Ceiling lamp
 Ø 40 cm, ↑ 15 cm
 excl. 3 x E27, max. 25 W



603500331
 603500332

Empfohlen:
 recommended: LED E27, 7 W
 560 lm, 3.000 K



988-700



31 | Weiß matt · white mat



32 | Schwarz matt · black mat



Wandleuchte · Wall lamp
 ↔ 40 x 13 cm, ↗ 6,5
 incl. 2 x SMD-LED, 6,5 W
 2 x 700 lm, 3.000 K

223510231
 223510232



Wandleuchte · Wall lamp
 ↔ 18 x 13 cm, ↗ 6 cm
 incl. 1 x SMD-LED, 6,5 W
 700 lm, 3.000 K

223510131
 223510132



ZANDOR

Metall, Weiß matt oder Schwarz matt, Acryl · metal, white mat or black mat, acryl ·
 metale, blanc mat ou noir mat, acryl · metaal, wit mat of mat zwart, acryl ·
 metal, estera blanca o estera negra, acrílico · metallo, bianco opaco o nero opaco, acrilico ·
 metal, alb mat sau negru mat, acrilic · metalli, mattavalkoinen tai mattamusta, akryyli ·
 metal, biały mat lub czarny mat, akryl

Pendelleuchte · Pendant
 Ø 50 cm, ↑ 150 cm
 excl. 3 x E27, max. 25 W



303500331
 303500332

Empfohlen:
 recommended: LED E27, 7 W
 560 lm, 3.000 K



988-700





BARON

Metall, Weiß matt oder Schwarz matt, Acryl · metal, white mat or black mat, acryl ·
metale, blanc mat ou noir mat, acryl · metaal, wit mat of mat zwart, acryl ·
metal, estera blanca o estera negra, acrílico · metallo, bianco opaco o nero opaco, acrilico ·
metal, alb mat sau negru mat, acrilic · metalli, mattavalkoinen tai mattamusta, akryyli ·
metal, biały mat lub czarny mat, akryl



Deckenleuchte · Ceiling lamp
Ø 52 cm, ↑ 24 cm
excl. 4 x E27, max. 40 W

Pendelleuchte · Pendant
Ø 52 cm, ↑ 150 cm
excl. 4 x E27, max. 40 W



609800431
609800432



309800431
309800432



31 | Weiß matt · white mat



32 | Schwarz matt · black mat





↑ ↓ Höhenverstellbar · Adjustable height

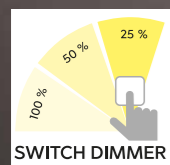

SWITCH DIMMER



MADISON

Metall, Glas · metal, glass ·
 metale, verre · metaal, glas · metal, vidrio ·
 metallo, vetro · metal, sticla · metalli, lasi ·
 metal, szkło



4 fach Sensorschalter
 4 level sensor switch



Tischleuchte · Table lamp
 ↑ 33 cm, Ø 18 cm
 incl. SMD-LED, 8 W
 800 lm, 3.000 K



542010107
 542010108



07 | Nickel matt · nickel mat



08 | Messing matt · brass mat



Pendelleuchte · Pendant
 ↑ 95 - 150 cm, Ø 18 cm
 incl. 1 x SMD-LED, 8 W
 900 lm, 3.000 K



342010107
 342010108



Pendelleuchte · Pendant
 ↑ 95 - 150 cm, ↔ 52 cm, Ø 18 cm
 incl. 2 x SMD-LED, 8 W
 2 x 900 lm, 3.000 K



342010207
 342010208



Pendelleuchte · Pendant
 ↑ 95 - 150 cm, ↔ 82 cm, Ø 18 cm
 incl. 3 x SMD-LED, 8 W
 3 x 900 lm, 3.000 K



342010307
 342010308

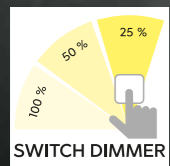

34 | Schwarz matt / Glas Weiß ·
black mat / glass white

32 | Schwarz matt / Glas Chrom bedampft ·
black mat / glass chrome plated

Tischleuchte · Table lamp
↑ 33 cm, Ø 18 cm
incl. SMD-LED, 8 W
800 lm, 3.000 K



542010132
542010134



4 fach Sensorschalter
4 level sensor switch



MADISON

Metall, Schwarz matt, Rauchglas · metal, black mat, smoked glass · métal, noir mat, verre fumé · metaal, mat zwart, rookglas · metal, estera negra, vidrio ahumado · metallo, nero opaco, vetro fume' · metal, negru mat, sticla fumurie · metalli, mattamusta, savulasi · metal, czarny mat, szkło przydymione

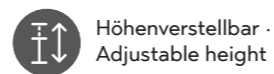

Pendelleuchte · Pendant
↑ 95 - 150 cm, Ø 18 cm
incl. 1 x SMD-LED, 8 W
900 lm, 3.000 K



342010132



Pendelleuchte · Pendant
↑ 95 - 150 cm, ↔ 52 cm, Ø 18 cm
incl. 2 x SMD-LED, 8 W
2 x 900 lm, 3.000 K



342010232



Pendelleuchte · Pendant
↑ 95 - 150 cm, ↔ 82 cm, Ø 18 cm
incl. 3 x SMD-LED, 8 W
3 x 900 lm, 3.000 K



342010332



DISCALGO

Metall, Kunststoff · metal, plastic ·
 metale, plastique · metaal, kunststof · metal, plástico ·
 metallo, plastica · metal, plastic · metalli, muovi · metal, plastik



31 | Weiß matt · white mat



32 | Schwarz matt · black mat



Deckenleuchte · Ceiling lamp
 Ø 54 cm, ↑ 30 cm
 excl. 3 x E14, max. 40 W



609900331
 609900332



Pendelleuchte · Pendant
 Ø 54 cm, ↑ 150 cm
 excl. 6 x E14, max. 40 W



309900631
 309900632



Metall, Glas Chrom bedampft · metal, glass chrome plated ·
 métal, verre chromé · metaal, glas verchromd · metal, vidrio acero cromado ·
 metallo, vetro cromato · metal, sticla cromat · metalli, lasi verlengbaar ·
 metal, szkło chromowany



Deckenleuchte · Ceiling lamp
 Ø 54 cm, ↑ 30 cm
 excl. 3 x E14, max. 40 W



609900357



Pendelleuchte · Pendant
 Ø 54 cm, ↑ 150 cm
 excl. 6 x E14, max. 40 W



309900657



VAPORE

Chrom, Glas chrom bedampft · chrome, chroom plated glass ·
 chrome, verre plaqué chrome · chroom, chroom opgedampt glas ·
 cromo, vidrio cromado · cromo, vetro verniciato cromo ·
 crom, sticla cromata · kromi, kromipäällystetty lasi ·
 chrom, szkło chromowane



Deckenleuchte · Ceiling lamp
 Ø 40 cm, † 22 cm
 excl. 5 x G9, max. 42 W

Pendelleuchte · Pendant
 Ø 50 cm, † 150 cm
 excl. 6 x G9, max. 42 W

Tischleuchte · Table lamp
 Ø 28 cm, † 43 cm
 excl. 3 x G9, max. 42 W

Empfohlen:
 recommended: LED G9, 3 W
 300 lm, 3.000 K

Pendelleuchte · Pendant
 Ø 40 cm, † 150 cm
 excl. 5 x G9, max. 42 W

Stehleuchte · Floor lamp
 Ø 40 cm, † 158 cm
 excl. 4 x G9, max. 42 W



611210506

311210606

511210306

929-230

311210506

411210406



Empfohlen:
recommended: Filament LED E14, 4 W
180 lm, 1.800 K



983-4813



LUMINA

Metall, Schwarz matt, Glas chrom bedampft · Metal, black mat, chrome plated glass ·
 métal, noir mat, verre plaqué chrome · metaal, mat zwart, chroom opgedampt glas · metal, estera negra, vidrio cromado ·
 metallo, nero opaco, vetro verniciato cromo · metal, negru mat, sticla cromata · metalli, mattamusta, kromipäällystetty lasi ·
 metal, czarny mat, szkło chromowane



Pendelleuchte · Pendant
 ↔ 69 x 8,5 cm, ↓ 150 cm
 excl. 3 x E14, max. 40 W



317000332



Pendelleuchte · Pendant
 ↔ 93 x 20 cm, ↓ 150 cm
 excl. 6 x E14, max. 40 W



317000632



Pendelleuchte · Pendant
 ↔ 121 x 20 cm, ↓ 150 cm
 excl. 8 x E14, max. 40 W



317000832



Stehleuchte · Floor lamp
 ↓ 200 cm, ↔ 72 cm, ∠ 68 cm
 excl. 3 x E14, max. 10 W





417000332



ALICIA

Chrom, Glas rauchfarbig · chrome, glass smoke · chrome, verre fumé · chroom, glas rookkleur · cromo, vidrio humo · cromo, vetro fume' · crom, sticla fumuriu · kromi, lasi savu · chrom, szkło przydymiony

Empfohlen:
recommended: LED G9, 2,3 W
200 lm, 3.000 K

929-220



Deckenleuchte · Ceiling lamp
Ø 45 cm, ↑ 46,5 cm
excl. 12 x G9, max. 10 W



607601206



Pendelleuchte · Pendant
↑ 150 cm, Ø 45 cm
excl. 12 x G9, max. 10 W



307601206



LORENA

Metall, Schwarz matt, Glas chrom bedampft · metal, black mat, chrome plated glass · métal, noir mat, verre plaqué chrome · metaal, mat zwart, chroom opgedampt glas · metal, estera negra, vidrio cromado · metallo, nero opaco, vetro verniciato cromo · metal, negru mat, sticla cromata · metalli, mattamusta, kromipäällystetty lasi · metal, czarny mat, szkło chromowane

Empfohlen:
recommended: Filament LED E27, 7 W
806 lm, 3.000 K



987-600



Deckenleuchte · Ceiling lamp
Ø 28,5 cm, ↑ 32 cm
excl. 1 x E27, max. 40 W



615190132



Pendelleuchte · Pendant
↑ 150 cm, Ø 41 cm
excl. 1 x E27, max. 40 W



315190132



Tischleuchte · Table lamp
↑ 30 cm, Ø 28,5 cm
excl. 1 x E27, max. 40 W



515190132



BALINI

Metall, Anthrazit, Rauchglas · metal, anthracite, smoked glass ·
métal, anthracite, verre fumé · metaal, antraciet, rookglas · metal, antracita, vidrio ahumado ·
metallo, antracite, vetro fume' · metal, antracit, sticla fumurie · metalli, antrasiitti, savulasi ·
metal, antracyt, szkło przydymione



Pendelleuchte · Pendant
Ø 30 cm, ↓ 150 cm
excl. 3 x E14, max. 28 W



308590342



Pendelleuchte · Pendant
↔ 100 x 16 cm, ↓ 150 cm
excl. 5 x E14, max. 28 W



308500542



Stehleuchte · Floor lamp
↓ 180 cm, ↔ 30 cm, ↗ 85 cm
excl. 5 x E14, max. 28 W



408500542

Empfohlen:
recommended: Filament LED E14, 4 W
470 lm, 2.700 K



983-400







 Pendelleuchte · Pendant
 ↓ 150 cm, Ø 10 cm
 excl. 1 x E27, max. 28 W

 310600132
 310600154



 Pendelleuchte · Pendant
 ↓ 150 cm, Ø 37 cm
 excl. 3 x E27, max. 28 W

 310630332
 310630354

 Pendelleuchte · Pendant
 ↓ 150 cm, ↔ 80,5 cm
 excl. 4 x E27, max. 28 W



 310600432
 310600454

 Tischleuchte · Table lamp
 ↓ 25,5 cm, Ø 11 cm
 excl. 1 x E27, max. 28 W

 
 510600132
 510600154

ROBIN

Metall, Glas · metal, glass ·
 metale, verre · metaal, glas · metal, vidrio ·
 metallo, vetro · metal, sticla · metalli, lasi · metal, szkło

-  **32** | Schwarz matt, Glas rauchfarbig · black mat, glass smoke
-  **54** | Messing matt, Glas rauchfarbig · brass mat, glass smoke

Empfohlen:
 recommended: Filament LED E27, 7 W
 400 lm, 1.800 K
 **986-4813**





Pendelleuchte · Pendant
 ↑ 150 cm, Ø 115 cm
 excl. 6 x E14, max. 28 W



302000632
 302000642

Empfohlen:
 recommended: LED E14, 3,5 W
 320 lm, 3.000 K



983-40

LED E14, 4 W
 470 lm, 2.700 K



983-400



Wandleuchte · Wall lamp
 ↑ 20,6 cm, ∠ 21,3 cm
 excl. 1 x E14, max. 28 W



202000132
 202000142



Tischleuchte · Table lamp
 ↑ 52 cm, ↔ 18 cm, ∠ 24,2 cm
 excl. 1 x E14, max. 28 W



502000132
 502000142

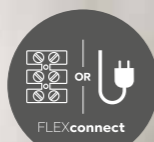

Seite/page 580



PURE

Metall, Glas · metal, glass ·
 metals, verre · metaal, glas · metal, vidrio ·
 metallo, vetro · metal, sticla · metalli, lasi · metal, szkło



32 | Schwarz matt, Glas Weiß ·
 black mat, glass white



42 | Anthazit, Rauchglas ·
 anthracite, smoked glass



Pendelleuchte · Pendant
 ↑ 150 cm, Ø 40 cm
 excl. 3 x E14, max. 28 W



302000332
 302000342



Stehleuchte · Floor lamp
 ↑ 150 cm, ↔ 25 cm, ∠ 31,7 cm
 excl. 1 x E14, max. 28 W



402000132
 402000142



Seite/page 580



PURE

Messing matt, Glas Weiß · brass mat, glass white ·
 laiton mat, verre blanc · messing mat, glas wit · bronze mate, vidrio blanco · ottone satinato, vetro bianco ·
 bronz mat, sticla alb · mattamessinki, lasi valkoinen · mosiądz mat, szkło biały



Wandleuchte · Wall lamp
 † 20,6 cm, † 21,3 cm
 excl. 1 x E14, max. 28 W



202000108



Pendelleuchte · Pendant
 † 150 cm, Ø 40 cm
 excl. 3 x E14, max. 28 W



302000308



Pendelleuchte · Pendant
 † 150 cm, Ø 115 cm
 excl. 6 x E14, max. 28 W



302000608



Tischleuchte · Table lamp
 † 52 cm, ↔ 18 cm, † 24,2 cm
 excl. 1 x E14, max. 28 W



502000108



Stehleuchte · Floor lamp
 † 150 cm, ↔ 25 cm, † 31,7 cm
 excl. 1 x E14, max. 28 W



402000108

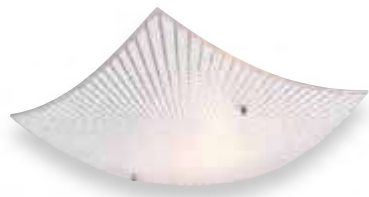

Deckenleuchte · Ceiling lamp
↔ 30 x 30 cm, ↓ 9 cm
excl. 1 x E27, max. 40 W



612200100



Deckenleuchte · Ceiling lamp
↔ 40 x 40 cm, ↓ 9,5 cm
excl. 2 x E27, max. 40 W



612200200



Wandleuchte · Wall lamp
↓ 22 cm, ↔ 20 cm, ↗ 8,5 cm
excl. 1 x E27, max. 40 W



212200100



Deckenleuchte · Ceiling lamp
↔ 30 x 30 cm, ↓ 9 cm
excl. 1 x E27, max. 40 W



604400101



Deckenleuchte · Ceiling lamp
↔ 40 x 40 cm, ↓ 9,5 cm
excl. 2 x E27, max. 40 W



604400201



Wandleuchte · Wall lamp
↔ 30 x 22 cm, ↗ 7,5 cm
excl. 1 x E27, max. 40 W



204400101

ELISA

Metall, Glas · metal, glass ·
métal, verre · metaal, glas · metal, vidrio · metallo, vetro · metal, sticla · metalli, lasi · metal, szkło



Pendelleuchte · Pendant
↓ 150 cm, ↔ 40 x 20 cm
excl. 2 x E27, max. 40 W



312200200



Empfohlen:
recommended: Filament LED E27, 4 W
470 lm, 2.700 K



987-400

SPIRELLI

Chrom, Dekorglas Weiß · chrome, glas decorated white ·
chrome, verre décoré blanc · chroom, decoratief glas wit · cromo, vidrio decorado blanco ·
cromo, vetro decorato bianco · crom, sticla decorativa alb · kromi, ornamenttilasi valkoinen ·
chrom, szkło dekoracyjne biały



Pendelleuchte · Pendant
↔ 40 x 20 cm, ↓ 150 cm
excl. 2 x E27, max. 40 W



304400201



SANDRINA

Dekorglas · glas decorated ·
verre décoré · decoratief glas · vidrio decorado ·
vetro decorato · sticla decorativa · ornamenttilasi · szkło dekoracyjne



Wandleuchte · Wall lamp
↔ 30 x 15 cm, ↗ 8 cm
excl. 1 x E27, max. 40 W



201200100



Deckenleuchte · Ceiling lamp
Ø 30 cm, ↓ 9 cm
excl. 1 x E27, max. 40 W



601200100



Deckenleuchte · Ceiling lamp
Ø 40 cm, ↓ 10 cm
excl. 2 x E27, max. 40 W



601200200



Pendelleuchte · Pendant
Ø 50 cm, ↓ 150 cm
excl. 3 x E27, max. 40 W



301200300



SIGNA

Chrom, Dekorglas Weiß · chrome, glas decorated white ·
chrome, verre décoré blanc · chroom, decoratief glas wit ·
cromo, vidrio decorado blanco · cromo, vetro decorato bianco ·
crom, sticla decorativa alb · kromi, ornamenttilasi valkoinen ·
chrom, szkło dekoracyjne biały



Wandleuchte · Wall lamp
↔ 20 x 30 cm, ↗ 9 cm
excl. 1 x E27, max. 40 W



202500101



Deckenleuchte · Ceiling lamp
↔ 30 x 30 cm, ↓ 9 cm
excl. 1 x E27, max. 40 W



602500101



Deckenleuchte · Ceiling lamp
↔ 40 x 40 cm, ↓ 9,5 cm
excl. 2 x E27, max. 40 W



602500201



Pendelleuchte · Pendant
Ø 50 cm, ↓ 150 cm
excl. 3 x E27, max. 40 W



302500301

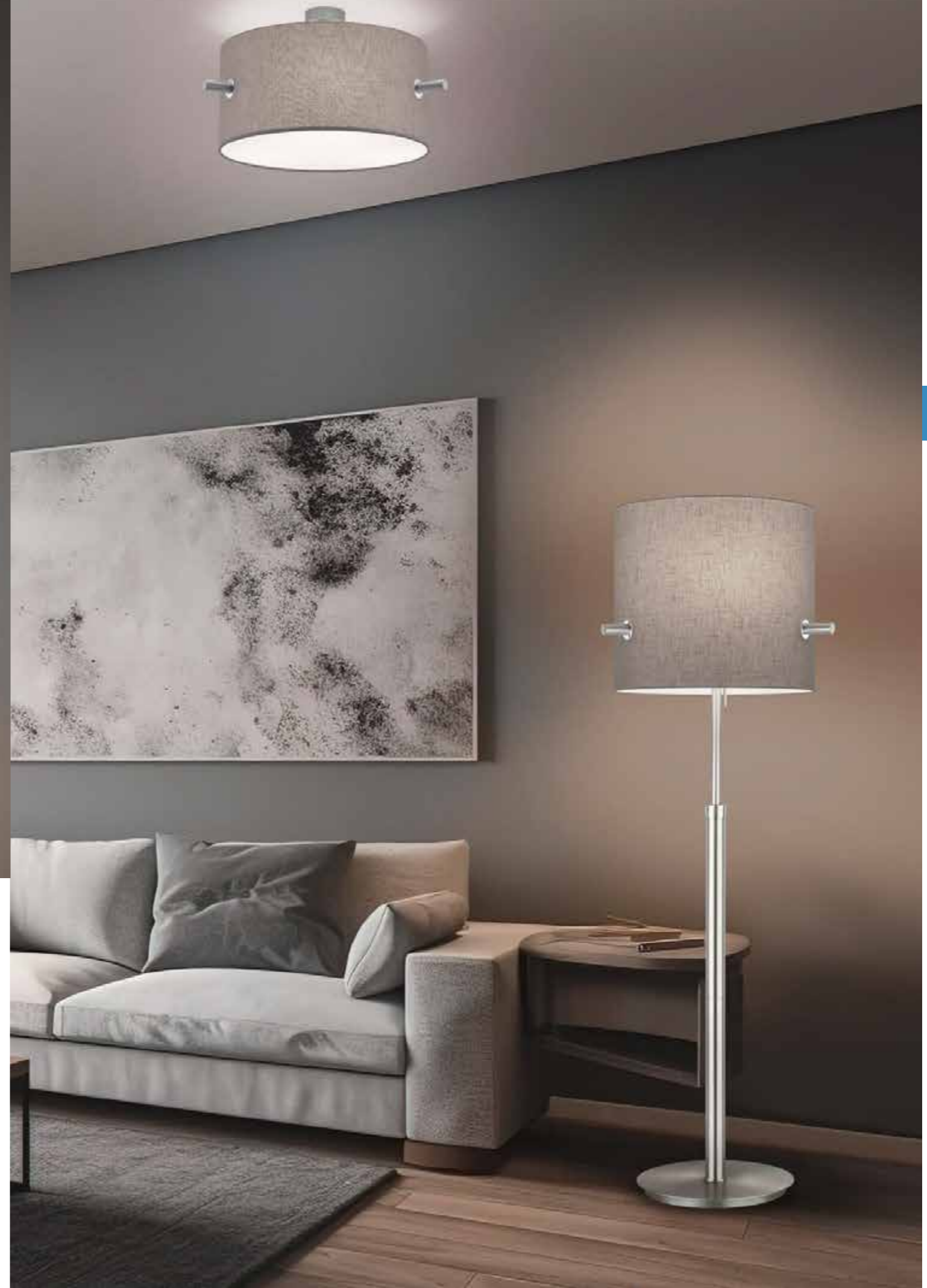

CAMDEN

Nickel matt, Stoffschirm · nickel mat, fabric shade ·
 nickel mat, abat-jour tissu · nikkell mat, Stoffen kap · níquel mate,
 Pantalla de tela · nichel opaco, paralume in tessuto · nichel mat, abajur textil ·
 harjattu teräs, kangas varjostin · nikiel mat, Klosz z materiału



Deckenleuchte · Ceiling lamp
 Ø 65 cm, ↑ 35 cm
 excl. 3 x E27, max. 60 W



608300307



Pendelleuchte · Pendant
 Ø 65 cm, ↑ 150 cm
 excl. 3 x E27, max. 60 W



308300307



Stehleuchte · Floor lamp
 ↑ 145 - 187 cm, Ø 65 cm
 excl. 3 x E27, max. 60 W



408300307



CAMDEN

Messing matt, Stoffschirm · brass mat, fabric shade ·
 laiton mat, abat-jour tissu · messing mat, Stoffen kap ·
 bronze mate, Pantalla de tela · ottone satinato, paralume in tessuto ·
 bronz mat, abajur textil · mattamessinki, kangas varjostin ·
 mosiądz mat, Klosz z materiału



Deckenleuchte · Ceiling lamp
 Ø 65 cm, † 35 cm
 excl. 3 x E27, max. 60 W



608300308



Pendelleuchte · Pendant
 Ø 65 cm, † 150 cm
 excl. 3 x E27, max. 60 W



308300308



Stehleuchte · Floor lamp
 † 145 - 187 cm, Ø 65 cm
 excl. 3 x E27, max. 60 W



408300308

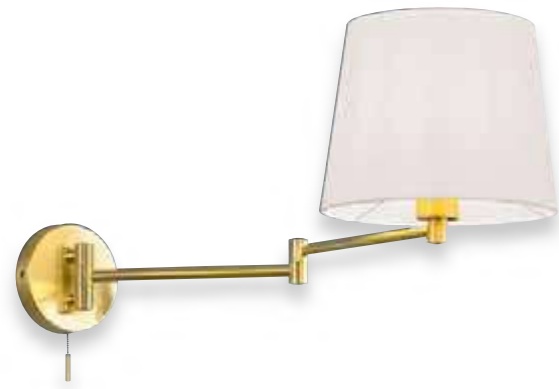

Wandleuchte · Wall lamp
 ↑ 32,5 x 25,5 cm, ↗ 69 cm
 excl. 1 x E27, max. 60 W



209100107
 209100108

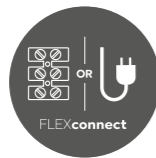

Seite/page 580



07 | Nickel matt ·
 nickel mat

08 | Messing matt ·
 brass mat

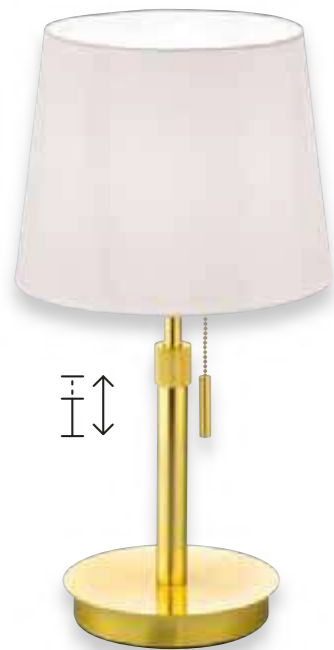

Tischleuchte · Table lamp
 ↑ 45 - 56 cm, Ø 25,5 cm
 excl. 1 x E27, max. 60 W



509100107
 509100108



LYON

Nickel matt oder Messing matt, Stoffschirm · nickel mat or brass mat, fabric shade ·
 nickel mat ou laiton mat, abat-jour tissu · nikkell mat of messing mat, Stoffen kap ·
 níquel mate o bronce mate, Pantalla de tela · nichel opaco o ottone satinato, paralume in tessuto ·
 nichel mat sau bronz mat, abajur textil · harjattu teräs tai mattamessinki, kangas varjostin ·
 nikiel mat lub mosiądz mat, Klosz z materiału



Getrennt schaltbar · Separately switchable ·
 Interrupteurs séparés · Gescheiden schakelbaar ·
 Interruptores separados · Interruttori separati ·
 Intreruptoare separate · Erikseen kytkettävissä ·
 Oddzielny przełącznik



Stehleuchte · Floor lamp
 ↑ 138 - 180 cm, Ø 46,3 cm
 excl. 3 x E27, max. 60 W



409100307
 409100308



01



02



11



Seite/page 580

01 | Weiß · white



02 | Schwarz · black



11 | Grau · grey



HOTEL

Nickel matt, Stoffschirm · nickel mat, fabric shade · nickel mat, abat-jour tissu · nikkell mat, Stoffen kap · níquel mate, Pantalla de tela · nichel opaco, paralume in tessuto · nichel mat, abajur textil · harjattu teräs, kangas varjostin · nikiel mat, Klosz z materiału



Wandleuchte · Wall lamp
↓ 23,5 x 20 cm, ↗ max. 34,5 cm
incl. 1 x SMD-LED, 3,1 W
310 lm, 3.000 K
excl. 1 x E14, max. 40 W



271170201
271170202
271170211



Stehleuchte · Floor lamp
↓ 150 - 215 cm, Ø 30 cm, ↗ 107 cm
excl. 1 x E27, max. 60 W



461100101
461100102
461100111



Stehleuchte · Floor lamp
↓ 160 cm, Ø 35 cm
excl. 1 x E27, max. 60 W



401100101
401100102
401100111





HOTEL

Nickel matt, Stoff · nickel mat, fabric · nickel mat, tissu · nikkel mat, textiel · níquel mate, tela · nichel opaco, tessuto · nichel mat, textil · harjattu teräs, tekstiili · nikiel mat, tkanina

-  01 | Weiß · white
-  02 | Schwarz · black
-  11 | Grau · grey



Deckenleuchte · Ceiling lamp
Ø 50 cm, ↓ 17 cm
excl. 3 x E27, max. 60 W



603900301
603900302
603900311



Deckenleuchte · Ceiling lamp
Ø 65 cm, ↓ 17 cm
excl. 5 x E27, max. 60 W



603900501
603900502
603900511

HOTEL

Stoffschirm, mehrfarbig · fabric shade, multicolor · abat-jour tissu, multicolore · Stoffen kap, multicolor · Pantalla de tela, multicolor · paralume in tessuto, multicolore · abajur textil, multicolor · kangas varjostin, monivärinen · Klosz z materiału, multi-kolor

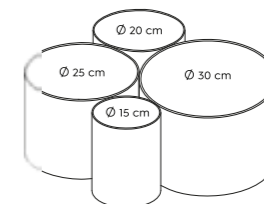

Deckenleuchte · Ceiling lamp
↔ 50,5 x 47 cm, ↓ 21,5 cm
excl. 4 x E27, max. 42 W



693900417

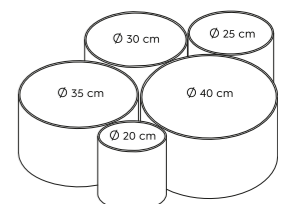

Deckenleuchte · Ceiling lamp
↔ 90 x 70 cm, ↓ 21,5 cm
excl. 5 x E27, max. 42 W



693900517



HOTEL

Nickel matt, Stoffschirm Weiß oder Schwarz · nickel mat, fabric shade white or black · nickel mat, abat-jour tissu blanc ou noir · nikkell mat, stoffen kap wit of zwart · níquel mate, pantalla de tela blanco o negro · nichel opaco, paralume in tessuto bianco o nero · nichel mat, abajur textil alb sau negru · harjattu teräs, kangas varjostin valkoinen tai musta · nikiel mat, klosz z materiału biały lub czarny



01 | Weiß · white



02 | Schwarz · black



Tischleuchte · Table lamp
↓ 32 cm, Ø 20 cm
excl. 1 x E14, max. 40 W



501100101
501100102



Tischleuchte · Table lamp
↓ 55 cm, Ø 30 cm
excl. 1 x E27, max. 60 W



511100101
511100102



01 | Nickel matt, Schirm Weiß · nickel mat, shade white



08 | Messing matt, Schirm Creme-Weiß · brass mat, shade cream white



11 | Nickel matt, Schirm Grau · nickel mat, shade grey



Stehleuchte · Floor lamp
↓ 170 cm, Ø 40 cm, √ 35 cm
excl. 1 x E27, max. 60 W
excl. 1 x E14, max. 18 W



403900201
403900208
403900211

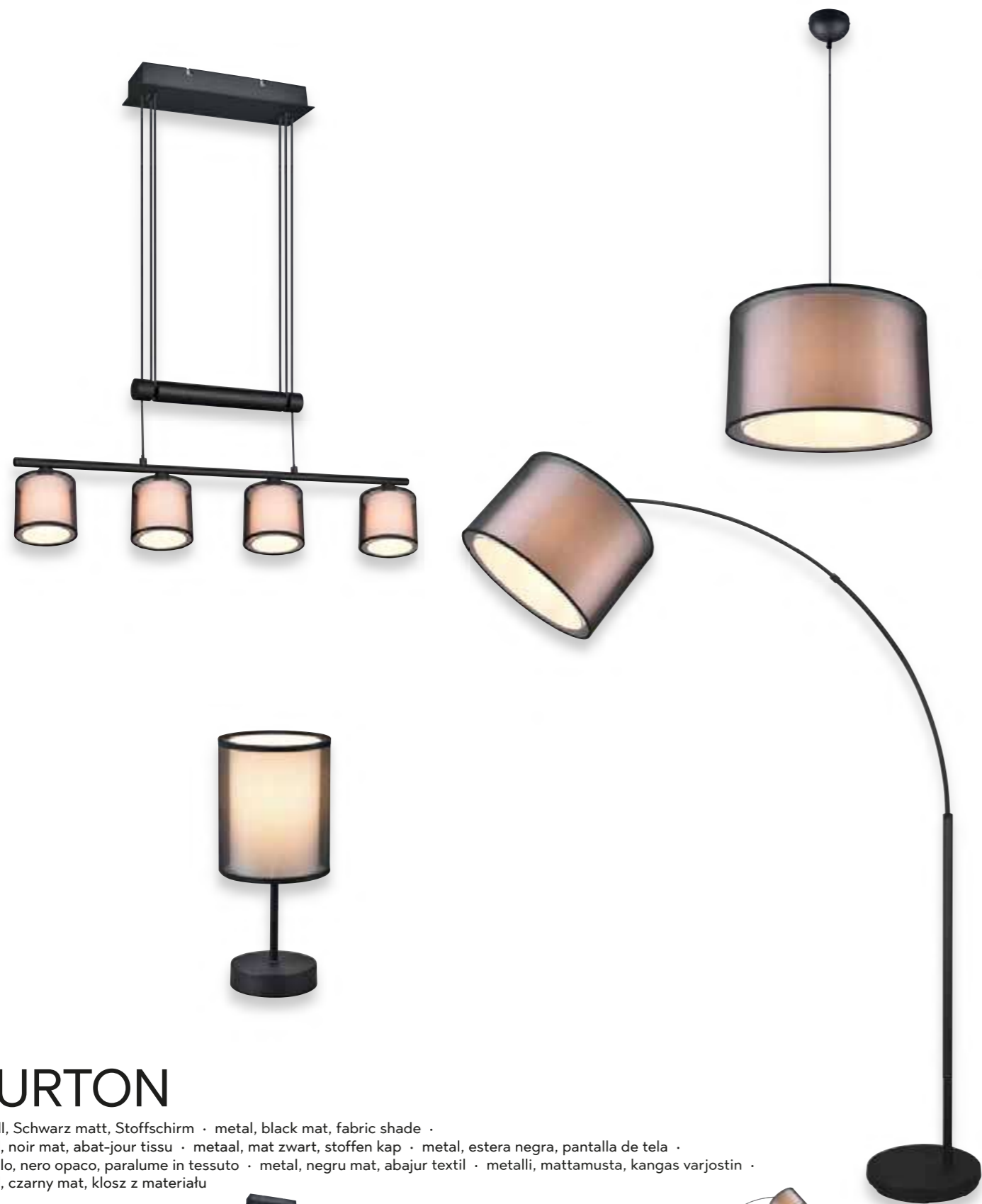

BURTON

Metall, Schwarz matt, Stoffschirm · metal, black mat, fabric shade ·
 métal, noir mat, abat-jour tissu · metaal, mat zwart, stoffen kap · metal, estera negra, pantalla de tela ·
 metallo, nero opaco, paralume in tessuto · metal, negru mat, abajur textil · metalli, mattamusta, kangas varjostin ·
 metal, czarny mat, klosz z materiału



Pendelleuchte · Pendant
 † 150 cm, Ø 45 cm
 excl. 1 x E27, max. 40 W



311400132



Pendelleuchte · Pendant
 † 95 - 150 cm, ↔ 82,5 x 12,5 cm
 excl. 4 x E14, max. 28 W



311400432



Tischleuchte · Table lamp
 † 28,5 cm, Ø 12,5 cm
 excl. 1 x E14, max. 28 W



511400132



Stehleuchte · Floor lamp
 † 171 cm, Ø 35 cm, † 120 cm
 excl. 1 x E27, max. 40 W



411490132



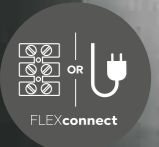

Seite/page 580



BURTON

Metall, Schwarz matt, Stoffschirm · metal, black mat, fabric shade ·
 métal, noir mat, abat-jour tissu · metaal, mat zwart, stoffen kap · metal, estera negra, pantalla de tela ·
 metallo, nero opaco, paralume in tessuto · metal, negru mat, abajur textil · metalli, mattamusta, kangas varjostin ·
 metal, czarny mat, klosz z materiału



Strahler · Spot
 ↑ 19,5 cm, ↔ 12 cm, ↗ 18,5 cm
 excl. 1 x E14, max. 28 W



811400132



Strahler · Spot
 ↔ 32,5 x 18 cm, ↑ 19,5 cm
 excl. 2 x E14, max. 28 W



811400232



Strahler · Spot
 ↔ 71,5 x 18 cm, ↑ 19,5 cm
 excl. 4 x E14, max. 28 W



811400432



Strahler · Spot
 Ø 49 cm, ↑ 22 cm
 excl. 3 x E14, max. 28 W



811430332



Deckenleuchte · Ceiling lamp
 Ø 50 cm, ↑ 25 cm
 excl. 3 x E27, max. 40 W



611400332



BURTON

Metall, Schwarz matt, Stoffschirm · metal, black mat, fabric shade ·
 métal, noir mat, abat-jour tissu · metaal, mat zwart, stoffen kap · metal, estera negra, pantalla de tela ·
 metallo, nero opaco, paralume in tessuto · metal, negru mat, abajur textil · metalli, mattamusta, kangas varjostin ·
 metal, czarny mat, klosz z materiału



Deckenleuchte · Ceiling lamp
 ↔ 65 x 55 cm, ↓ 21,5 cm
 excl. 3 x E27, max. 40 W



611490332



Deckenleuchte · Ceiling lamp
 ↔ 90 x 70 cm, ↓ 21,5 cm
 excl. 5 x E27, max. 40 W



611400532



Stehleuchte · Floor lamp
 ↓ 150 cm, Ø 35 cm
 excl. 1 x E27, max. 40 W



411400132



Stehleuchte · Floor lamp
 ↓ 174 cm, Ø 45 cm
 excl. 1 x E27, max. 60 W
 excl. 1 x E14, max. 40 W



411400232





Deckenleuchte · Ceiling lamp
Ø 30 cm, ↑ 22 cm
excl. 2 x E14, max. 40 W



508200179



Stehleuchte · Floor lamp
↑ 160,5 cm, Ø 35 cm
excl. 1 x E27, max. 60 W



408200179



HOSTEL

Metall, Stoffschirm innen goldfarbig · metal, fabric shade gold colored inside ·
metale, abat-jour tissu Or · metaal, Stoffen kap Binnenkant goudkleur ·
metal, Pantalla de tela Interior en color dorado · metallo, paralume in tessuto
interno colore oro · metal, abajur textil interior culoare aurie · metalli, kangas
varjostin sisäosa kullanvärinen · metal, Klosz z materiału wewnątrz złoty



Pendelleuchte · Pendant
Ø 40 cm, ↑ 150 cm
excl. 1 x E27, max. 60 W



308200179



Stehleuchte · Floor lamp
↑ max. 156 cm, Ø 35 cm, ∠ max. 63 cm
excl. 1 x E27, max. 60 W



408290179



Deckenleuchte · Ceiling lamp
↔ 75 x 44,2 cm, ↑ 22 cm
excl. 5 x E14, max. 25 W



- 605400501
- 605400511
- 605400579



Tischleuchte · Table lamp
↑ 18 cm, Ø 9,5 cm
excl. 1 x E14, max. 25 W



- 595400101
- 595400111
- 595400179



GARDA

Nickel matt, Stoffschirm · nikkell mat, fabric shade ·
nickel mat, abat-jour tissu · nikkell mat, Stoffen kap · níquel mate, Pantalla de tela ·
nichel opaco, paralume in tessuto · nichel mat, abajur textil · harjattu teräs, kangas varjostin ·
nikiel mat, Klosz z materiału



Pendelleuchte · Pendant
↔ 77 x 13,5 cm, ↑ 95 - 150 cm
excl. 4 x E14, max. 28 W



- 305400401
- 305400411
- 305400441
- 305400479



ROSS

Metall, schwarz matt, Stoffschirm · metal, black mat, fabric shade ·
 metale, noir mat, abat-jour tissu · metaal, mat zwart, Stoffen kap ·
 metal, estera negra, Pantalla de tela · metallo, nero opaco, paralume in tessuto ·
 metal, negru mat, abajur textil · metalli, mattamusta, kangas varjostin ·
 metal, czarny mat, Klosz z materiafu

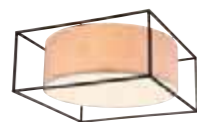

Deckenleuchte · Ceiling lamp
 ↔ 30 x 30 cm, ↓ 15,5 cm
 excl. 2 x E27, max. 40 W

Deckenleuchte · Ceiling lamp
 ↔ 50 x 50 cm, ↓ 22,5 cm
 excl. 3 x E27, max. 40 W

Deckenleuchte · Ceiling lamp
 ↔ 40,5 x 34 cm, ↓ 28,5 cm
 excl. 3 x E27, max. 40 W

Tischleuchte · Table lamp
 ↓ 22 cm, ↔ 14 x 14 cm
 excl. 1 x E27, max. 40 W

Pendelleuchte · Pendant
 ↔ 100 x 20 cm, ↓ 150 cm
 excl. 34 x E27, max. 40 W

Stehleuchte · Floor lamp
 ↓ 153 cm, ↔ 29 x 29 cm
 excl. 3 x E27, max. 40 W



603100244

603100344

603130317

503100144

303100417

403100317





JULIETA

Metall, Schwarz matt, Samt, innen goldfarbig · metal, black mat, velvet, gold colored inside ·
 métal, noir mat, velours, or · metaal, mat zwart, fluweel, binnenkant goudkleur ·
 metal, estera negra, terciopelo, interior en color dorado · metallo, nero opaco, velluto, interno colore oro ·
 metal, negru mat, catifea, interior culoare aurie · metalli, mattamusta, sametti, sisäosa kullanvärinen ·
 metal, czarny mat, aksamit, wewnątrz złoty



Deckenleuchte · Ceiling lamp
 Ø 30 cm, ↑ 22 cm
 excl. 2 x E14, max. 40 W



619000244

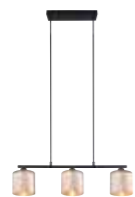

Pendelleuchte · Pendant
 ↔ 66 x 12 cm, ↑ 150 cm
 excl. 3 x E14, max. 40 W



319000344



Tischleuchte · Table lamp
 ↑ 20 cm, Ø 30 cm
 excl. 1 x E27, max. 40 W



519000144



Stehleuchte · Floor lamp
 ↑ 156 cm, Ø 35 cm, ∠ 63 cm
 excl. 1 x E27, max. 40 W



419000144



AGUDO

Metall, Schwarz matt / Coffee · metal, black mat / coffee ·
 métal, noir mat / café · metaal, mat zwart / koffie · metal, estera negra / café · metallo, nero opaco / caffè ·
 metal, negru mat / cafea · metalli, mattamusta / antiikkiteräs · metal, czarny mat / kawa



Deckenleuchte · Ceiling lamp
 Ø 30 cm, ↑ 24,5 cm
 excl. 3 x E27, max. 40 W



619430317



Pendelleuchte · Pendant
 Ø 37 cm, ↑ 150 cm
 excl. 3 x E27, max. 40 W



319430317

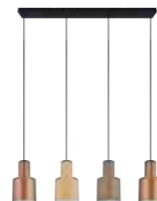

Pendelleuchte · Pendant
 ↔ 87 x 12 cm, ↑ 150 cm
 excl. 4 x E27, max. 40 W



319400417

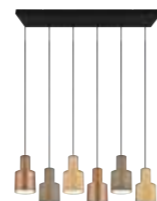

Pendelleuchte · Pendant
 ↔ 85 x 27 cm, ↑ 150 cm
 excl. 6 x E27, max. 40 W



319400617





ROXIE

Metall, Schwarz matt, goldfarbig · metal, black mat, gold ·
 métal, noir mat, or · metaal, mat zwart, goud · metal, estera negra, oro ·
 metallo, nero opaco, oro · metal, negru mat, aur · metalli, mattamusta, kultaa · metal, czarny mat, złota



Pendelleuchte · Pendant
 † 150 cm, Ø 60 cm
 excl. 6 x E14, max. 10 W



311900632



Pendelleuchte · Pendant
 † 150 cm, ↔ 113 x 69 cm
 excl. 7 x E14, max. 10 W



311900732



Tischleuchte · Table lamp
 † 43 cm, ↔ 17 cm, ∠ 25,5 cm
 excl. 1 x E14, max. 10 W



511900132



Stehleuchte · Floor lamp
 † 155 cm, ↔ 43 cm, ∠ 23 cm
 excl. 2 x E14, max. 10 W



411900232



Seite/page 580

ROXIE

Metall, Schwarz matt, goldfarbig · metal, black mat, gold ·
 métal, noir mat, or · metaal, mat zwart, goud · metal, estera negra, oro ·
 metallo, nero opaco, oro · metal, negru mat, aur · metalli, mattamusta, kultaa ·
 metal, czarny mat, złota



Strahler · Spot
 ↑ 22,7 cm, ↔ 10 cm, ↗ 15,7 cm
 excl. 1 x E14, max. 10 W



811900132



Strahler · Spot
 ↔ 40 x 13,8 cm, ↑ 22,8 cm
 excl. 2 x E14, max. 10 W



811900232



Strahler · Spot
 ↔ 60 x 13,8 cm, ↑ 22,8 cm
 excl. 3 x E14, max. 10 W



811900332



Deckenleuchte · Ceiling lamp
 Ø 66 cm, ↑ 33 cm
 excl. 6 x E14, max. 10 W



611900632





TAMIL

Metall oder Metall / Holz naturbelassen · metal or metal / wood natural finish ·
 métal ou métal / bois finition naturelle · metaal of metaal / hout natuurlijke afwerking ·
 metal o metal / maderacabado natural · metallo o metallo / di legno finitura naturale ·
 metal sau metal / lemn finisaj natural · metalli tai metalli / puu luonnollinen viimeistely ·
 metal lub metal / drewno naturalne wykończenie



08 | Messing matt · brass mat

67 | Nickel antik · nickel antique

Empfohlen:
 recommended: Filament LED E27, 4,5 W
 470 lm, 2.700 K



987-400



Deckenleuchte · Ceiling lamp
 Ø 50 cm, ↑ 22,5 cm
 excl. 3 x E27, max. 40 W



611100308
 611100367



Pendelleuchte · Pendant
 ↑ 150 cm, Ø 50 cm
 excl. 3 x E27, max. 40 W



311100308
 311100367

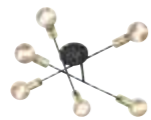

Pendelleuchte · Pendant
 Ø 54,5 cm, † 150 cm
 excl. 6 x E27, max. 28 W



306700632
 306700602 | Schwarz · black

Deckenleuchte · Ceiling lamp
 Ø 56,6 cm, † 19,1 cm
 excl. 6 x E27, max. 40 W



606700632

Stehleuchte · Floor lamp
 † 165 cm, Ø 54,5 cm
 excl. 6 x E27, max. 28 W



406700632



CROSS

Metall, Schwarz matt / goldfarbig · metal, black mat / gold ·
 metale, noir mat / or · metaal, mat zwart / goud ·
 metal, estera negra / oro · metallo, nero opaco / oro ·
 metal, negru mat / aur · metalli, musta matto / kultaa ·
 metal, czarny mat / złota

Empfohlen:
 recommended: Filament LED E27, 6 W
 660 lm, 2.700 K



988-679

Pendelleuchte · Pendant
 ↔ 91 x 45 cm, † 150 cm
 excl. 7 x E27, max. 28 W



306700732



Seite/page 580



DIALLO

Metall, Schwarz matt · metal, black mat ·
metale, noir mat · metaal, mat zwart · metal, estera negra ·
metallo, nero opaco · metal, negru mat · metalli, musta matto ·
metal, czarny mat



Wandleuchte · Wall lamp
↑ 15 x 10 cm, ↗ 20 cm
excl. 1 x E27, max. 42 W



208070132



Tischleuchte · Table lamp
↑ 51 cm, ↔ 15 cm, ↗ 23,5 cm
excl. 1 x E27, max. 42 W



508000132



Stehleuchte · Floor lamp
↑ 149 cm, ↔ 23 cm, ↗ 39,3 cm
excl. 1 x E27, max. 42 W



408000132

Empfohlen:
recommended: Filament LED E27, 7 W
806 lm, 3.000 K



988-600

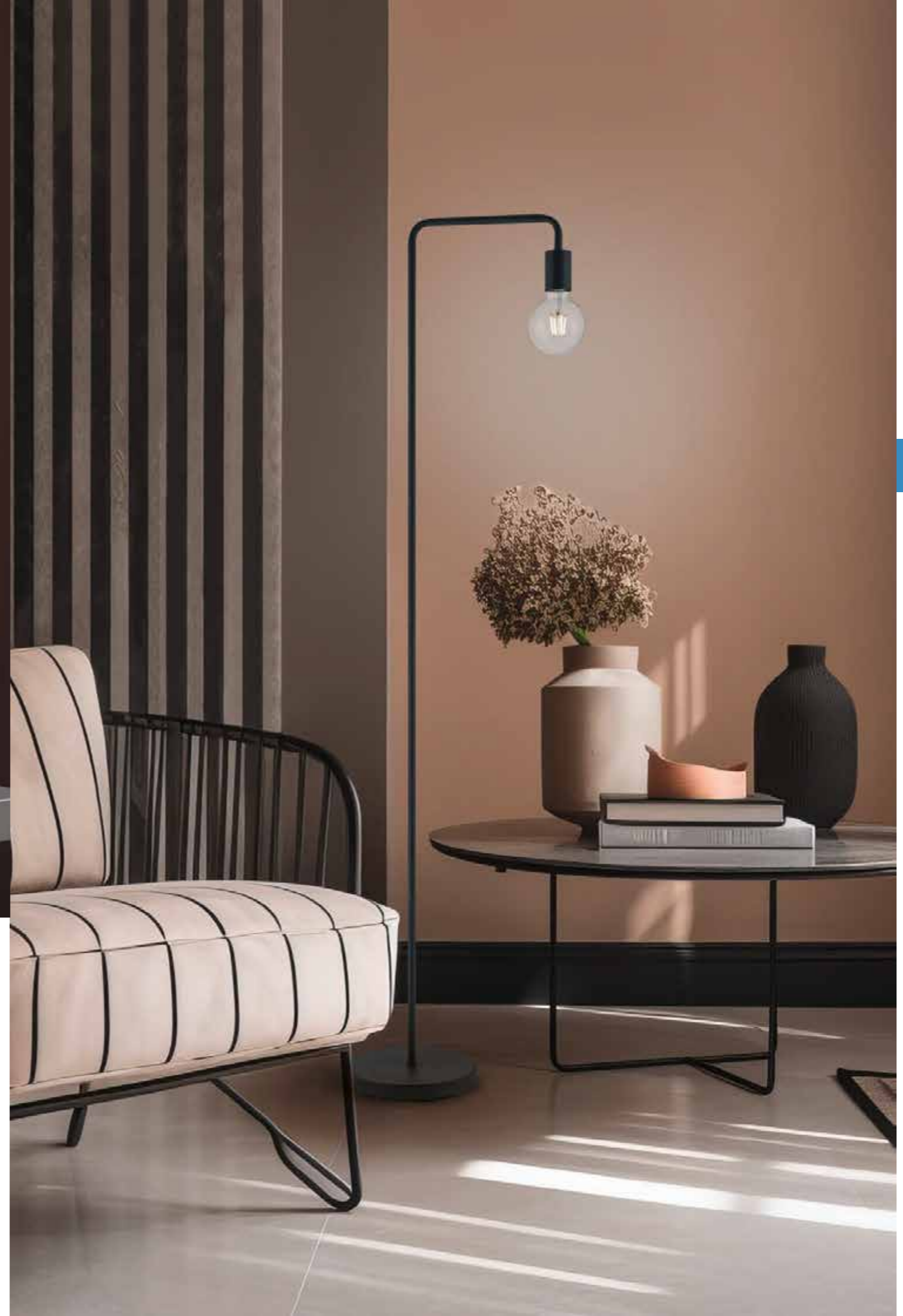



RUSTICA

Metall, rostfarbig, Glas matt · metal, rusty, mat glass ·
metale, rouille, verre mat · metaal, roestkleur, mat glas ·
metal, óxido, vidrio mate · metallo, ruggine, vetro sabbiato ·
metal, ruginiu, sticla mata · metalli, rustiikki, mattalasi ·
metal, miedz, szklo matowane



Deckenleuchte · Ceiling lamp
Ø 55 cm, † 42,5 cm
excl. 3 x E14, max. 40 W



601000324



Pendelleuchte · Pendant
† 150 cm, Ø 55 cm
excl. 3 x E14, max. 40 W



101000324



Pendelleuchte · Pendant
† 150 cm, Ø 60 cm
excl. 5 x E14, max. 40 W



101000524

Empfohlen:
recommended: LED E14, 3,5 W
320 lm, 3.000 K



983-40



RUSTICA

Metall, rostfarbig, Glas matt · metal, rusty, mat glass ·
 metale, rouille, verre mat · metaal, roestkleur, mat glas ·
 metal, óxido, vidrio mate · metallo, ruggine, vetro sabbaiato ·
 metal, ruginiu, sticla mata · metalli, rustiikki, mattalasi ·
 metal, miedź, szkło matowane



Deckenleuchte · Ceiling lamp
 Ø 38 cm, ↑ 16,5 cm
 excl. 2 x E27, max. 60 W



6102021-24



Tischleuchte · Table lamp
 ↑ 50 cm, Ø 31 cm
 excl. 2 x E14, max. 40 W



501000224



Stehleuchte · Floor lamp
 ↑ 180 cm, Ø 33,5 cm
 excl. 2 x E27, max. 60 W



401000224



Stehleuchte · Floor lamp
 ↑ 180 cm, Ø 32,5 cm
 excl. 1 x E27, max. 100 W
 excl. 1 x E14, max. 40 W



4602021-24





Pendelleuchte · Pendant
 Ø 70 cm, † 150 cm
 excl. 3 x E14, max. 40 W



110700328



Pendelleuchte · Pendant
 Ø 70 cm, † 150 cm
 excl. 5 x E14, max. 40 W



110700528



Deckenleuchte · Ceiling lamp
 Ø 61 cm, † 26 cm
 excl. 3 x E14, max. 40 W



600700328



TRADITIO

Metall, Glas alabasterfarbig · metal, alabaster-coloured glass ·
 metale, verre couleur albâtre · metaal, albastkleurig glas ·
 metal, vidrio de color alabastro · metallo, vetro colore alabastro ·
 metal, sticla culoare alabastru · metalli, lasi alabasteri väri ·
 metal, szkło alabaster kolor

Empfohlen:
 recommended: LED E14, 3,5 W
 320 lm, 3.000 K



983-40



Wandleuchte · Wall lamp
 ↔ 12 x 21,5 cm, † 29 cm
 excl. 1 x E14, max. 40 W



200700128



Tischleuchte · Table lamp
 † 32 x 16 cm, † 27 cm
 excl. 1 x E14, max. 40 W



500700128



Natur & Design

- Nature & Design
- Nature et design
- Natuur en design
- Naturalidad & Diseño
- Natura e design
- Natură și design
- Luonto ja suunnittelu
- Naturalność i dizajn



HARPER

Metall, Schwarz matt, Holz naturbelassen · metal, black mat, wood natural finish ·
 métal, noir mat, bois finition naturelle · metaal, mat zwart, hout natuurlijke afwerking ·
 metal, estera negra, madera acabado natural · metallo, nero opaco, di legno finitura naturale ·
 metal, negru mat, lemn finisaj natural · metalli, mattamusta, puu luonnollinen viimeistely ·
 metal, czarny mat, drewno naturalne wykończenie

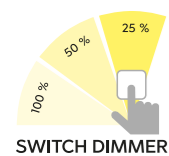

SWITCH DIMMER



Deckenleuchte · Ceiling lamp
 ↔ 65 x 34,5 cm, ↑ 7,5 cm
 incl. SMD-LED, 30 W
 4.000 lm, 3.000 K



622910332



Deckenleuchte · Ceiling lamp
 ↔ 115 x 44,5 cm, ↑ 7,5 cm
 incl. SMD-LED, 42 W
 5.700 lm, 3.000 K



622910532



Pendelleuchte · Pendant
 ↓ 150 cm, ↔ 115 x 44,5 cm
 incl. SMD-LED, 42 W
 5.700 lm, 3.000 K



322910532

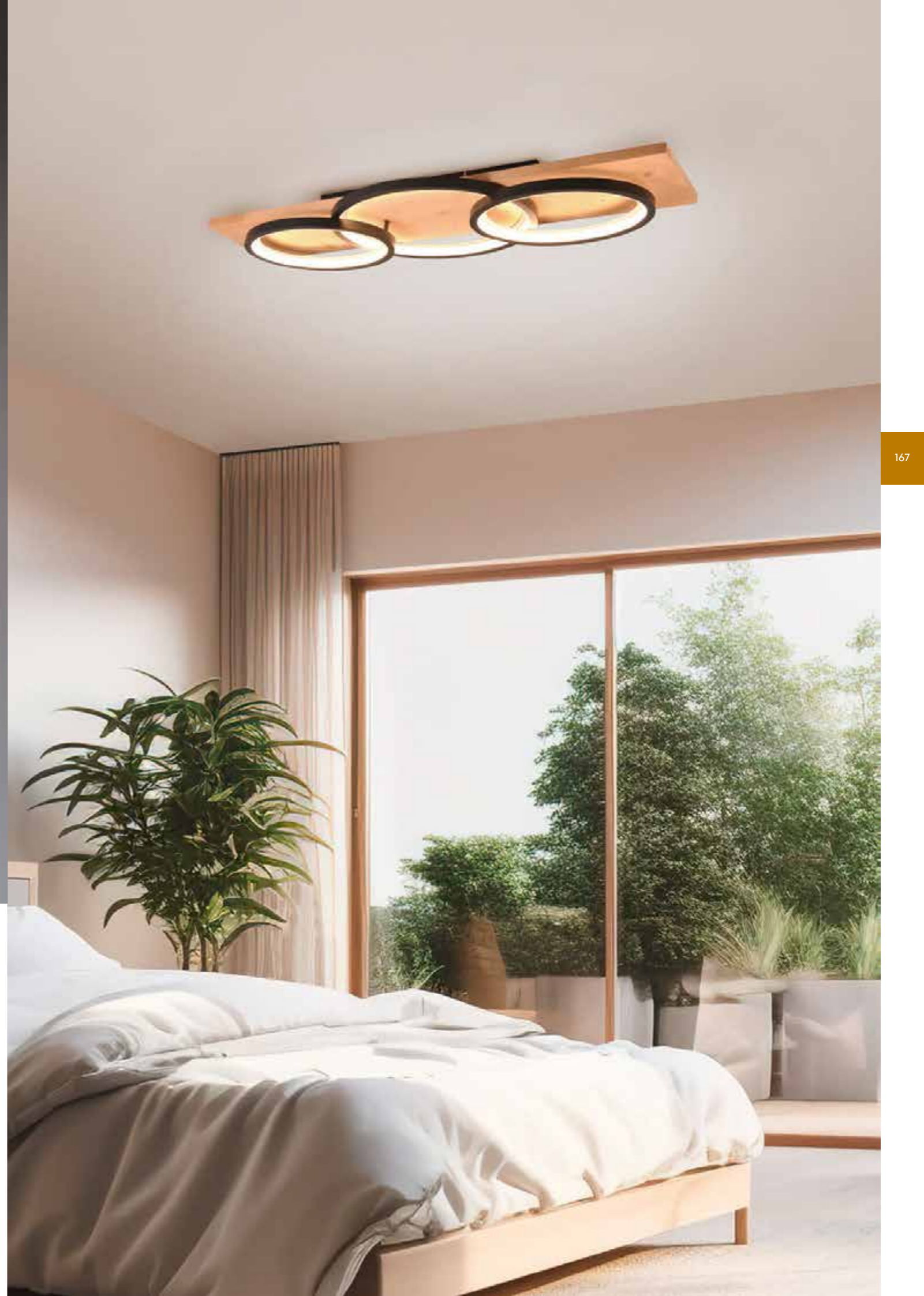

BARCA

Metall, Weiß matt oder Schwarz matt, Holz naturbelassen · metal, white mat or black mat, wood natural finish ·
 métal, blanc mat ou noir mat, bois finition naturelle · metaal, wit mat mat zwart, hout natuurlijke afwerking · metal, estera blanca o estera negra,
 madera acabado natural · metallo, bianco opaco o nero opaco, di legno finitura naturale · metal, alb mat sau negru mat, lemn finisaj natural ·
 metalli, mattavalkoinen tai mattamusta, puu luonnollinen viimeistely · metal, biały mat lub czarny mat, drewno naturalne wykończenie

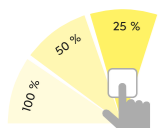

SWITCH DIMMER



Wandleuchte · Wall lamp
 ↔ 44 x 24 cm, ↓ 8 cm
 incl. SMD-LED, 16 W
 1.800 lm, 3.000 K



241110131
 241110132



Deckenleuchte · Ceiling lamp
 ↔ 75 x 33 cm, ↓ 10 cm
 incl. SMD-LED, 30 W
 3.500 lm, 3.000 K



641110231
 641110232



Deckenleuchte · Ceiling lamp
 ↔ 97 x 33 cm, ↓ 10 cm
 incl. SMD-LED, 40 W
 4.700 lm, 3.000 K



641110331
 641110332



RAMA

Metall, Schwarz matt, Holz naturbelassen · metal, black mat, wood natural finish ·
 métal, noir mat, bois finition naturelle · metaal, mat zwart, hout natuurlijke afwerking ·
 metal, estera negra, madera acabado natural · metallo, nero opaco, di legno finitura naturale ·
 metal, negru mat, lemn finisaj natural · metalli, mattamusta, puu luonnollinen viimeistely ·
 metal, czarny mat, drewno naturalne wykończenie

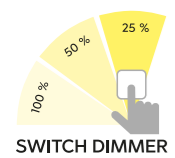

SWITCH DIMMER



Deckenleuchte · Ceiling lamp
 ↔ 67,5 x 32,5 cm, ↑ 12,5 cm
 incl. SMD-LED, 32 W
 3.800 lm, 3.000 K



643210332



Deckenleuchte · Ceiling lamp
 ↔ 72 x 32,5 cm, ↑ 12,5 cm
 incl. SMD-LED, 36 W
 4.200 lm, 3.000 K



643210432

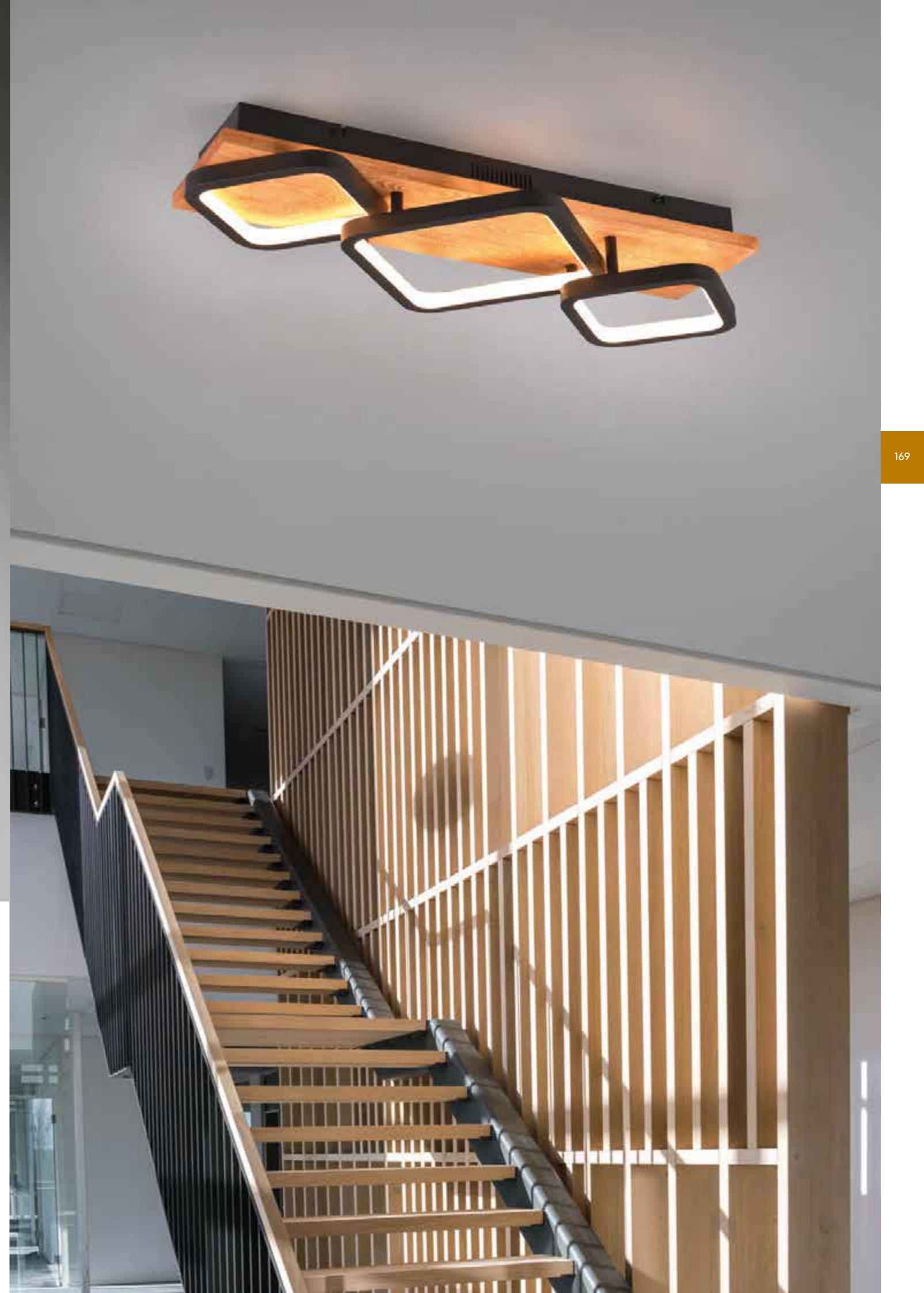



MEDERA

Metall, Holz · metal, wood ·
metale, bois · metaal, hout · metal, madera · metallo, di legno ·
metal, lemn · metalli, puu · metal, drewno · metal, tahta

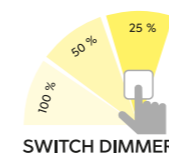

32 | Schwarz matt/Weiß ·
black mat/white

Deckenleuchte · Ceiling lamp
↔ 53,5 x 34,5 cm, ↑ 8 cm
incl. SMD-LED, 26 W
3.000 lm, 3.000 K

87 | titanfarbig/Schwarz ·
titan/black

643810232
643810287

Deckenleuchte · Ceiling lamp
↔ 80 x 34,5 cm, ↑ 8 cm
incl. SMD-LED, 33 W
3.800 lm, 3.000 K

643810332
643810387

Deckenleuchte · Ceiling lamp
↔ 100 x 34,5 cm, ↑ 8 cm
incl. SMD-LED, 44 W
5.100 lm, 3.000 K

643810432
643810487



KERALA

Metall, Schwarz matt, Holz naturbelassen · metal, black mat, wood natural finish ·
 métal, noir mat, bois finition naturelle · metaal, mat zwart, hout natuurlijke afwerking ·
 metal, estera negra, madera acabado natural · metallo, nero opaco, di legno finitura naturale ·
 metal, negru mat, lemn finisaj natural · metalli, mattamusta, puu luonnollinen viimeistely ·
 metal, czarny mat, drewno naturalne wykończenie

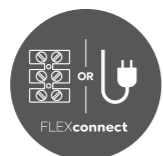

Seite/page 580



Wandleuchte · Wall lamp
 ↓ 7 cm, ↔ 30 cm, ↗ 13 cm
 incl. SMD-LED, 9 W
 1.100 lm, 3.000 K



241670132



Deckenleuchte · Ceiling lamp
 ↔ 83 x 14,5 cm, ↓ 11,5 cm
 incl. 2 x SMD-LED, 12,5 W
 2 x 1.500 lm, 3.000 K



641610232



Pendelleuchte · Pendant
 ↓ 150 cm, ↔ 90 x 8,5 cm
 incl. SMD-LED, 25 W
 3.000 lm, 3.000 K



341610132



Tischleuchte · Table lamp
 ↓ 50 cm, ↔ 11 x 14 cm
 incl. SMD-LED, 8 W
 950 lm, 3.000 K



541610132



Stehleuchte · Floor lamp
 ↓ 120 cm, ↔ 19 x 13 cm
 incl. SMD-LED, 16 W
 1.950 lm, 3.000 K



441610132



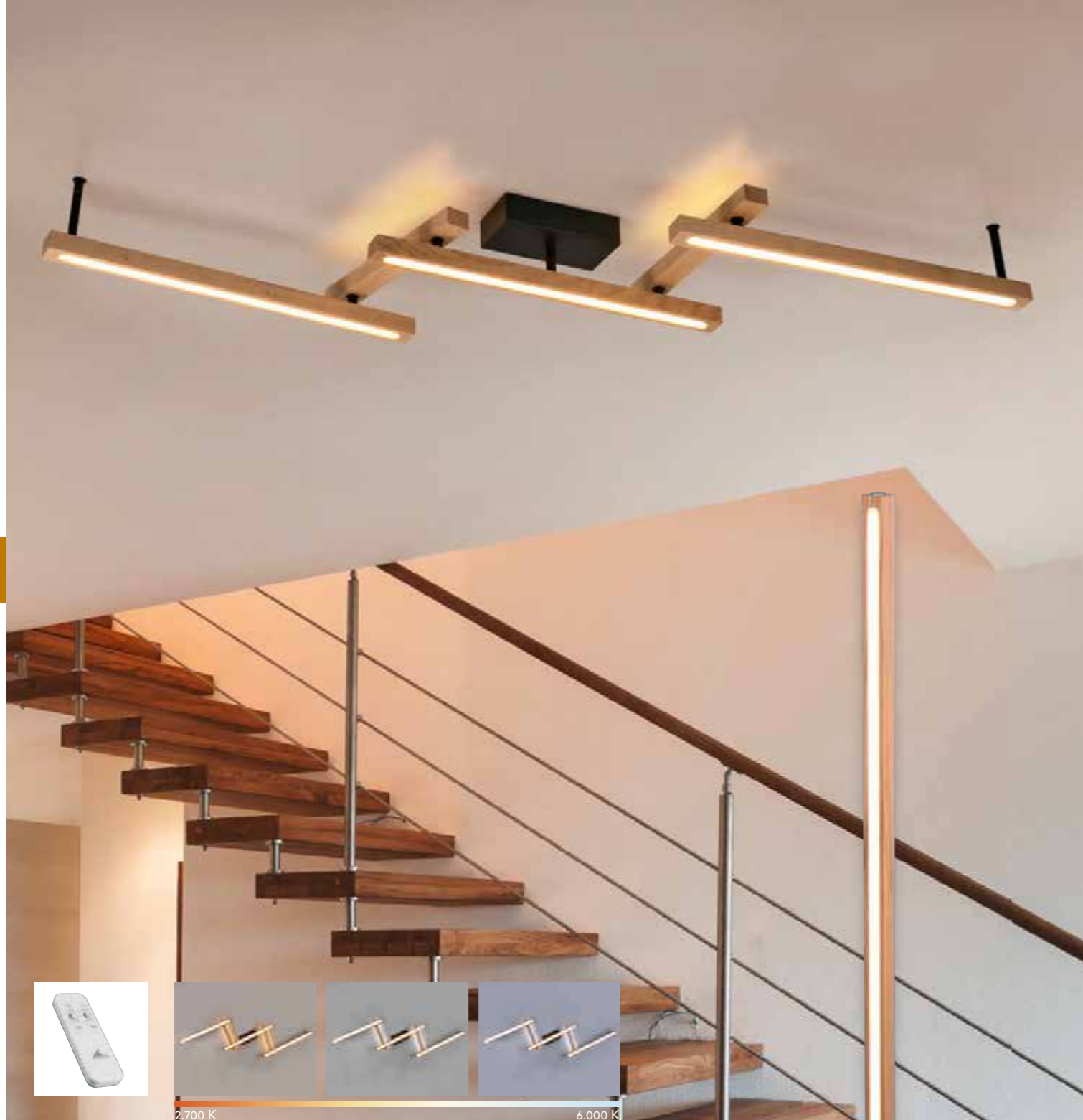

2.700 K

6.000 K

BELLARI

Holz, Metall Schwarz matt · wood, metal black mat ·
bois, metale noir mat · hout, metaal mat zwart · madera, metal estera negra ·
di legno, metallo nero opaco · lemn, metal negru mat · puu, metalli mattamusta ·
drewno, metal czarny mat



Deckenleuchte · Ceiling lamp
↔ 180 x 10 cm, ↑ 13,5 cm
incl. SMD-LED, 36 W
4.200 lm, 2.700 - 6.000 K



626410530



Stehleuchte · Floor lamp
↑ 115 cm, ↔ 22 x 22 cm
incl. SMD-LED, 20 W
2.300 lm, 3.000 K



426410130



4 fach TOUCH ·
4 level Touch function



Sensordimmer ·
Sensor dimmer

Lichtfarbe stufenlos einstellbar ·
Light color infinitely variable

DEACON

Metall, Schwarz matt, Holz · metal, black mat, wood ·
metale, noir mat, bois · metaal, mat zwart, hout · metal, estera negra, madera ·
metallo, nero opaco, di legno · metal, negru mat, lemn · metalli, mattamusta, puu ·
metal, czarny mat, drewno



Deckenleuchte · Ceiling lamp
Ø 50 cm, ↑ 7 cm
incl. SMD-LED, 37 W
4.400 lm, 3.000 K



626610232



Pendelleuchte · Pendant
↔ 110 x 6,5 cm, ↑ 150 cm
incl. SMD-LED, 42 W
5.000 lm, 2.700 - 6.000 K



326610232

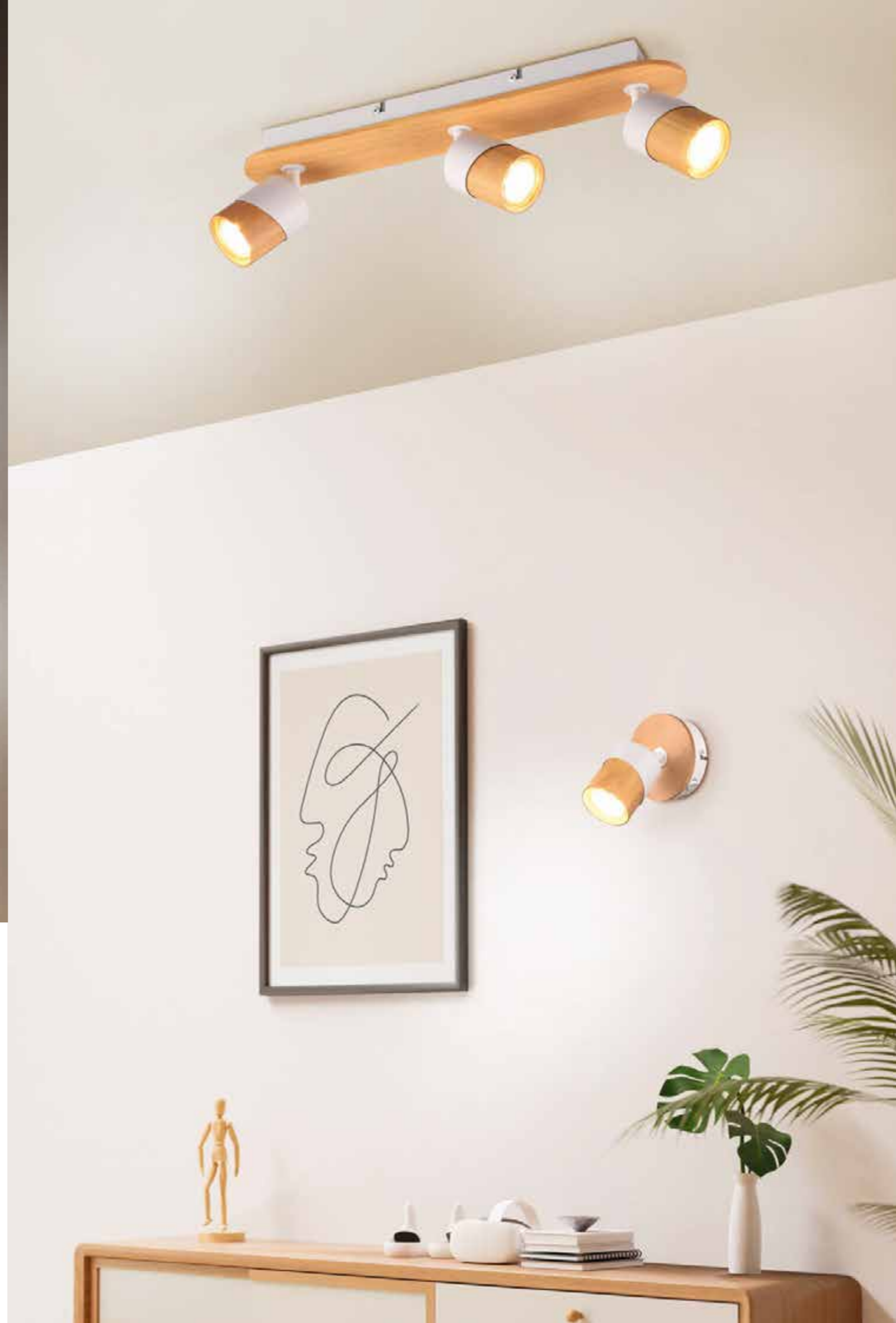

ARUNI

Metall, Weiß matt oder Schwarz matt, Holz naturbelassen · metal, white mat or black mat, wood natural finish ·
 métal, blanc mat ou noir mat, bois finition naturelle · metaal, wit mat mat zwart, hout natuurlijke afwerking · metal, estera blanca o estera negra,
 madera acabado natural · metallo, bianco opaco o nero opaco, di legno finitura naturale · metal, alb mat sau negru mat, lemn finisaj natural ·
 metalli, mattavalkoinen tai mattamusta, puu luonnollinen viimeistely · metal, biały mat lub czarny mat, drewno naturalne wykończenie



Strahler · Spot
 Ø 11 cm, ↗ 15 cm
 excl. 1 x GU10, max. 5 W



801170131
 801170132



Strahler · Spot
 ↔ 28 x 9 cm, ↑ 15 cm
 excl. 2 x GU10, max. 5 W



801100231
 801100232



Strahler · Spot
 ↔ 48 x 9 cm, ↑ 15 cm
 excl. 3 x GU10, max. 5 W



801100331
 801100332

Empfohlen:
 recommended: LED GU10, 4,5 W
 345 lm, 3.000 K



956-55



TAILOR

Metall, Nickel antik, Holz · metal, nickel antique, wood ·
 metale, nickel antique, bois · metaal, antiek nikkel, hout · metal, níquel antiguo, madera ·
 metallo, nickel anticato, di legno · metal, nichel antic, lemn · metalli, antiikkiteräs, puu ·
 metal, aikiel antyczny, drewno



Deckenleuchte · Ceiling lamp
 ↔ 115 x 20 cm, ↑ 15,7 cm
 excl. 4 x E27, max. 10 W



614300430



Pendelleuchte · Pendant
 ↔ 115 x 20 cm, ↑ 150 cm
 excl. 4 x E27, max. 10 W



314300430



Tischleuchte · Table lamp
 ↓ 52,5 cm, ↔ 22 x 15 cm
 excl. 2 x E27, max. 10 W



514300230



Stehleuchte · Floor lamp
 ↑ 142,5 cm, ↔ 30 x 22 cm
 excl. 5 x E27, max. 10 W



414300530





BRAD

Nickel antik, Holz · nickel antique, wood ·
 nickel antique, bois · antiek nikkell, hout · níquel antiguo, madera ·
 nickel anticato, di legno · nichel antic , lemn · antiikkiteräs, puu ·
 aikiel antyczny, drewno · antik nikel, tahta

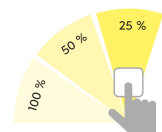

SWITCH DIMMER



Wandleuchte · Wall lamp
 ↑ 11 x 11 cm, ↗ 11 cm
 incl. OSRAM-LED, 4,3 W
 430 lm, 3.000 K



223710130



Wandleuchte · Wall lamp
 ↓ 11 x 37 cm, ↗ 11 cm
 incl. SMD-LED, 13,5 W
 1.500 lm, 3.000 K



223790130



Deckenleuchte · Ceiling lamp
 ↔ 100 x 20 cm, ↓ 16,7 cm
 incl. SMD-LED, 27 W
 3.400 lm, 3.000 K



623710130



Pendelleuchte · Pendant
 ↔ 100 x 20 cm, ↓ 150 cm
 incl. SMD-LED, 27 W
 3.400 lm, 3.000 K



323710130

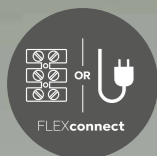

Seite/page 580

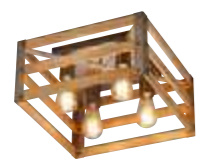

Deckenleuchte · Ceiling lamp
↔ 40 x 40 cm, ↓ 20 cm
excl. 4 x E27, max. 28 W



605500467



Wandleuchte · Wall lamp
↓ 20 cm, ↔ 15 cm, ↗ 11 cm
excl. 1 x E27, max. 28 W



205570167



Wandleuchte · Wall lamp
↓ 20 cm, ↔ 35 cm, ↗ 11 cm
excl. 2 x E27, max. 28 W



205570267



KHAN

Nickel antik, Holz · nickel antique, wood ·
nickel antique, bois · antiek nikkell, hout · níquel antiguo, madera ·
nickel anticato, di legno · nichel antic, lemn · antiikkiteräs, puu ·
aikiel antyczny, drewno · antik nikel, tahta

Empfohlen:
recommended: Filament LED E27, 6 W
600 lm, 2.700 K



987-679



Stehleuchte · Floor lamp
↓ 153 cm, ↔ 25 x 25 cm
excl. 3 x E27, max. 10 W



405500367



Pendelleuchte · Pendant
↔ 100 x 15 cm, ↓ 150 cm
excl. 4 x E27, max. 28 W



305500467



HEDDA

Metall, Schwarz matt, Sisal · metal, black mat, Sisal ·
metale, noir mat, Sisal · metaal, mat zwart, Sisal · metal, estera negra, Sisal ·
metallo, nero opaco, Sisal · metal, negru mat, Sisal · metalli, mattamusta, Sisal ·
metal, czarny mat, Sizal

Empfohlen:
recommended: Filament LED E27, 4 W
470 lm, 2.700 K



987-400



Deckenleuchte · Ceiling lamp
Ø 52 cm, ↑ 28 cm
excl. 2 x E27, max. 40 W



612300236



Pendelleuchte · Pendant
Ø 52 cm, ↑ 150 cm
excl. 1 x E27, max. 40 W



312300136



Stehleuchte · Floor lamp
↑ 150 cm, Ø 52 cm
excl. 1 x E27, max. 40 W



402300136





INGA

Rattangeflecht, Metall, Schwarz matt · rattan meshwork, metal, black mat ·
 maillage rotin, métal, noir mat · rotan vlechtwerk, metaal, mat zwart · malla de Rattan, metal, estera negra ·
 reticolo rattan, metallo, nero opaco · impletitura ratan, metal, negru mat · rottinki, metalli, mattamusta · rattan, metal, czarny mat



Deckenleuchte · Ceiling lamp
 Ø 50 cm, † 30 cm
 excl. 3 x E27, max. 40 W

 **612200336**



Pendelleuchte · Pendant
 Ø 29 cm, † 150 cm
 excl. 1 x E27, max. 40 W

 **312200136**



Pendelleuchte · Pendant
 Ø 50 cm, † 150 cm
 excl. 3 x E27, max. 40 W

 **312200336**



Tischleuchte · Table lamp
 † 30 cm, Ø 16,5 cm
 excl. 1 x E27, max. 40 W

  **512200136**

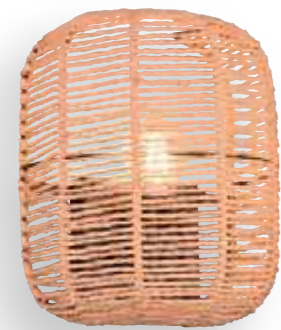

RUNA

Metall, Schwarz matt, Sisal · metal, black mat, Sisal ·
metale, noir mat, Sisal · metaal, mat zwart, Sisal · metal, estera negra, Sisal · metallo, nero opaco, Sisal ·
metal, negru mat, Sisal · metalli, mattamusta, Sisal · metal, czarny mat, Sizal



Wandleuchte · Wall lamp
↑ 27,5 cm, ↔ 23 cm, ∠ 15 cm
excl. 1 x E27, max. 40 W



203000132



Pendelleuchte · Pendant
Ø 25 cm, ↑ 150 cm
excl. 1 x E27, max. 40 W



303000132



Pendelleuchte · Pendant
Ø 35 cm, ↑ 150 cm
excl. 1 x E27, max. 40 W



303090132



Stehleuchte · Floor lamp
↑ 150 cm, Ø 35 cm
excl. 1 x E27, max. 40 W



403000132



COLINO

Metall, Holz · metal, wood ·
 metale, bois · metaal, hout · metal, madera · metallo, di legno ·
 metal, lemn · metalli, puu · metal, drewno · metal, tahta

Empfohlen:
 recommended: Filament LED E27, 4 W
 470 lm, 2.700 K



987-400



32 | Schwarz matt · black mat



42 | naturbelassen · natural finish



Deckenleuchte · Ceiling lamp
 Ø 40 cm, † 26 cm
 excl. 2 x E27, max. 40 W



615900232
 615900242



Pendelleuchte · Pendant
 Ø 40 cm, † 150 cm,
 excl. 1 x E27, max. 40 W



315900132
 315900142

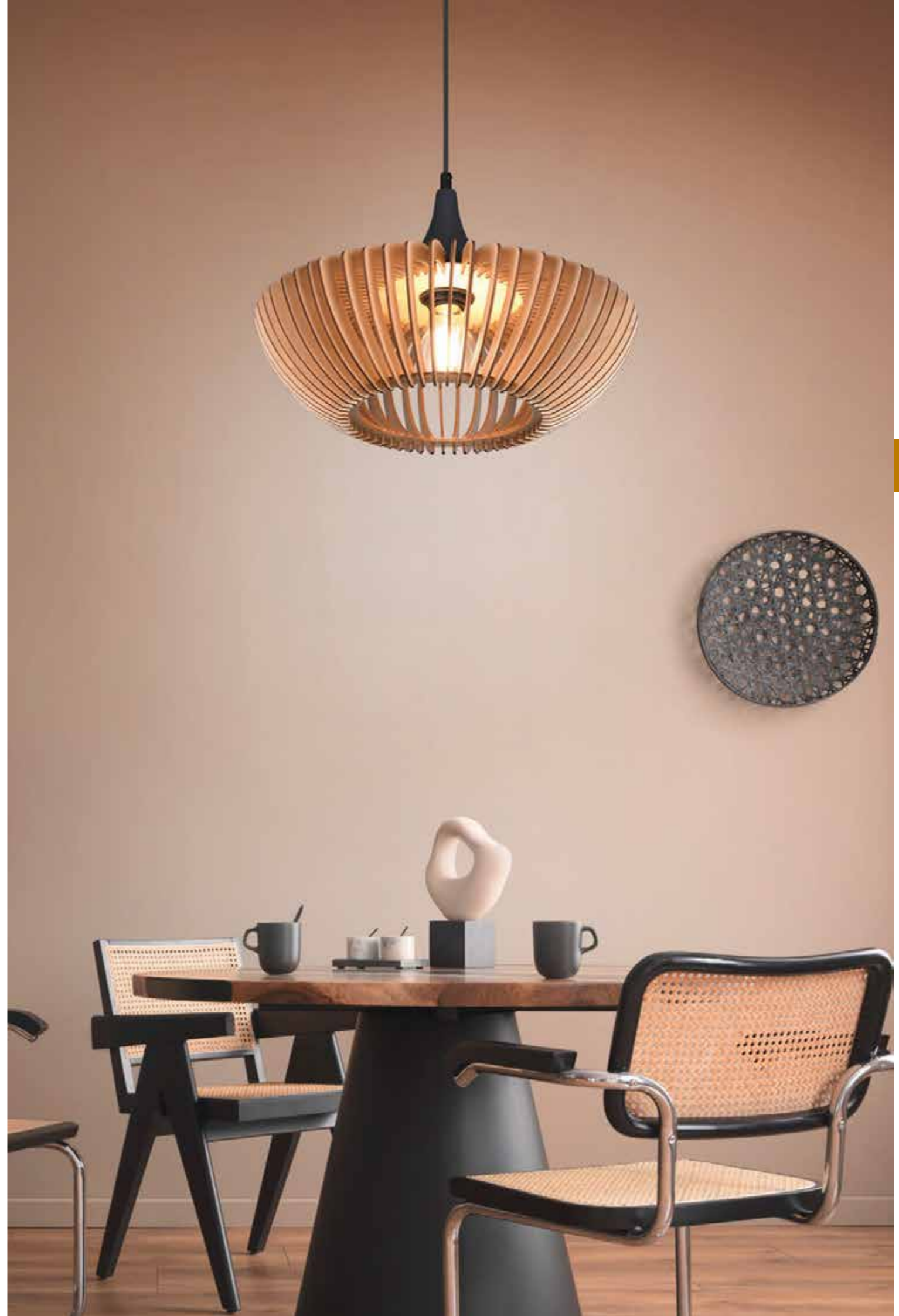



KORBA

Holz, Stoffschirm · wood, fabric shade ·
 bois, abat-jour tissu · hout, Stoffen kap ·
 madera, Pantalla de tela · di legno, paralume in tessuto ·
 lemn, abajur textil · puu, kangas varjostin ·
 drewno, Klosz z materiału · tahta, Kumaş şapka



Stehleuchte · Floor lamp
 † 162 cm, Ø 40 cm
 excl. 1 x E27, max. 60 W



401200101

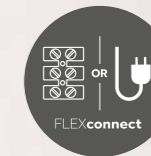

Seite/page 580

NILAM

Holz, Stoffschirm · wood, fabric shade ·
 bois, abat-jour tissu · hout, Stoffen kap ·
 madera, Pantalla de tela · di legno, paralume in tessuto ·
 lemn, abajur textil · puu, kangas varjostin ·
 drewno, Klosz z materiału · tahta, Kumaş şapka



Getrennt schaltbar ·
 Separately switchable



Flexibel ·
 Flexible



Wandleuchte · Wall lamp
 † 30 x 25 cm, † 38 cm
 incl. SMD-LED, 3,1 W
 310 lm, 3.000 K
 excl. 1 x E27, max. 28 W



212870236



Wandleuchte · Wall lamp
 † 30 x 18 cm, † 38 cm
 incl. SMD-LED, 3,1 W
 310 lm, 3.000 K
 excl. 1 x E27, max. 28 W



212879236



ELMAU

Holz, Stoffschirm · wood, fabric shade ·
 bois, abat-jour tissu · hout, Stoffen kap · madera, Pantalla de tela ·
 di legno, paralume in tessuto · lemn, abajur textil · puu, kangas varjostin · drewno, Klosz z materiału



Deckenleuchte · Ceiling lamp
 Ø 35 cm, ↑ 36,5 cm
 excl. 1 x E27, max. 60 W



602100130



Pendelleuchte · Pendant
 Ø 35 cm, ↑ 150 cm
 excl. 1 x E27, max. 60 W



302100130



Pendelleuchte · Pendant
 ↔ 100 x 20 cm, ↑ 150 cm
 excl. 4 x E27, max. 60 W



302100430



Tischleuchte · Table lamp
 ↑ 40 cm, Ø 18 cm
 excl. 1 x E14, max. 40 W



502100130



SAESONS

Holz naturbelassen, Stoff · wood natural finish, fabric ·
 bois finition naturelle, tissu · hout natuurlijke afwerking, textiel ·
 madera acabado natural, tela · di legno finitura naturale, tessuto ·
 lemn finisaj natural, textil · puu luonnollinen viimeistely, tekstiili ·
 drewno naturalne wykończenie, tkanina

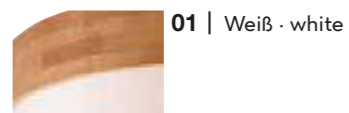

01 | Weiß · white

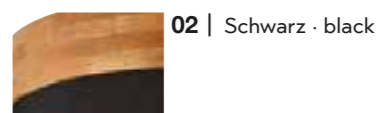

02 | Schwarz · black



Deckenleuchte · Ceiling lamp
 Ø 30 cm, ↓ 22 cm
 excl. 2 x E14, max. 40 W



611500201
 611500202



Deckenleuchte · Ceiling lamp
 Ø 50 cm, ↓ 22 cm
 excl. 3 x E27, max. 40 W



611500301
 611500302





Deckenleuchte · Ceiling lamp
 ↔ 42,5 x 14,5 cm, ↓ 23,2 cm
 excl. 2 x E14, max. 25 W



801900267



Deckenleuchte · Ceiling lamp
 ↔ 54 x 14,5 cm, ↓ 23 cm
 excl. 3 x E14, max. 25 W



801900367



Wandleuchte · Wall lamp
 ↔ 11 x 11 cm, ↓ 23,2 cm
 excl. 1 x E14, max. 25 W



801900167



Deckenleuchte · Ceiling lamp
 ↔ 39 x 39 cm, ↓ 19,8 cm
 excl. 4 x E14, max. 25 W



601900467



Stehleuchte · Floor lamp
 ↓ 150 cm, ↔ 25 x 25 cm
 excl. 3 x E14, max. 25 W



401900367



Seite/page 580



BELL

Metall, Nickel antik, innen goldfarbig, Holz · metal, nickel antique, gold colored inside, wood ·
 metale, nickel antique, Or, bois · metaal, antiek nikkel, Binnenkant goudkleur, hout ·
 metal, níquel antiguo, Interior en color dorado, madera · metallo, nickel anticato,
 interno colore oro, di legno · metal, nichel antic, interior culoare aurie, lemn ·
 metalli, antiikkiteräs, sisäosa kullanvärinen, puu · metal, aikiel antyczny, wewnątrz złoty, drewno

Empfohlen:
 recommended: Filament LED E14, 4 W
 470 lm, 3.000 K



983-400



Pendelleuchte · Pendant
 ↔ 100 x 21 cm, ↓ 150 cm
 excl. 4 x E14, max. 25 W



301900467



DELHI

Metall, Nickel antik, Holz · metal, nickel antique, wood ·
 metale, nickel antique, bois · metaal, antiek nikkel, hout · metal, níquel antiguo, madera ·
 metallo, nickel anticato, di legno · metal, nichel antic, lemn ·
 metalli, antiikkiteräs, puu · metal, aikiel antyczny, drewno

Empfohlen:
 recommended: Filament LED E27, 4 W
 470 lm, 2.700 K



987-400



Pendelleuchte · Pendant
 Ø 45 cm, ↓ 150 cm
 excl. 1 x E27, max. 60 W



303400167



Pendelleuchte · Pendant
 ↔ 107,5 cm, ↓ max. 215 cm, Ø 25,5 cm
 excl. 3 x E27, max. 42 W



303400367



DELHI

Metall, Nickel antik, Holz · metal, nickel antique, wood ·
 metale, nickel antique, bois · metaal, antiek nikkel, hout · metal, níquel antiguo, madera ·
 metallo, nickel anticato, di legno · metal, nichel antic, lemn · metalli, antiikkiteräs, puu ·
 metal, aikiel antyczny, drewno



Wandleuchte · Wall lamp
 Ø 11,6 cm, ↗ 20,5 cm
 excl. 1 x E14, max. 40 W



803400167



Deckenleuchte · Ceiling lamp
 ↔ 33 x 11,6 cm, ↓ 20,5 cm
 excl. 2 x E14, max. 40 W



803400267



Deckenleuchte · Ceiling lamp
 ↔ 58 x 11,6 cm, ↓ 20,5 cm
 excl. 3 x E14, max. 40 W



803400367



Stehleuchte · Floor lamp
 ↑ 158 cm, ↔ 66 cm, Ø 40 cm
 excl. 1 x E27, max. 60 W



403400167



AGRA

Metall, Schwarz matt, Holz · metal, black mat, wood ·
 metale, noir mat, bois · metaal, mat zwart, hout · metal, estera negra, madera ·
 metallo, nero opaco, di legno · metal, negru mat, lemn · metalli, mattamusta, puu ·
 metal, czarny mat, drewno

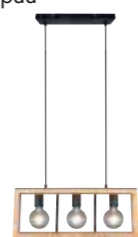

Pendelleuchte · Pendant
 ↔ 60 x 8,5 cm, ↑ 150 cm
 excl. 3 x E27, max. 10 W



313800332



Pendelleuchte · Pendant
 ↔ 100 x 8,5 cm, ↑ 150 cm
 excl. 5 x E27, max. 10 W



313800532

Empfohlen:
 recommended: Filament LED E27, 4 W
 470 lm, 2.700 K



987-400

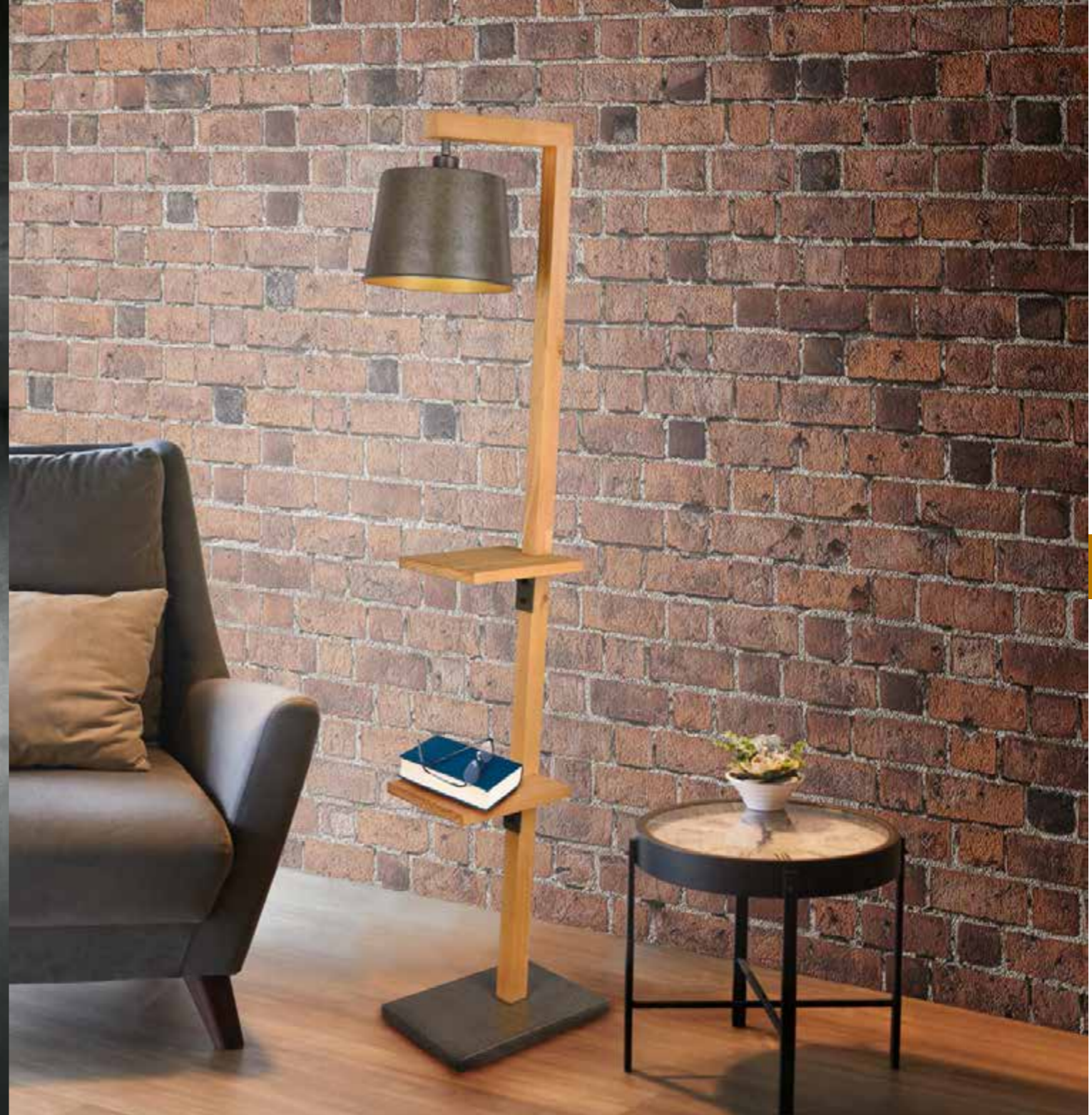

RODRIGO

Metall, Nickel antik, innen goldfarbig, Holz · metal, nickel antique, gold colored inside, wood ·
 metale, nickel antique, Or, bois · metaal, antiek nikkel, Binnenkant goudkleur, hout ·
 metal, níquel antiguo, Interior en color dorado, madera · metallo, nickel anticato, interno colore oro, di legno ·
 metal, nichel antic, interior culoare aurie, lemn · metalli, antiikkiteräs, sisäosa kullanvärinen, puu ·
 metal, aikiel antyczny, wewnątrz złoty, drewno



Stehleuchte · Floor lamp
 ↑ 165 cm, ↔ 26 cm, ↗ 41 cm
 excl. 1 x E27, max. 60 W



402690167



HARRIS

Metall, Schwarz matt, innen goldfarbig, Holz · metal, black mat, gold colored inside, wood ·
 metale, noir mat, Or, bois · metaal, mat zwart, Binnenkant goudkleur, hout ·
 metal, estera negra, Interior en color dorado, madera · metallo, nero opaco, interno colore oro, di legno ·
 metal, negru mat, interior culoare aurie, lemn · metalli, mattamusta, sisäosa kullanvärinen, puu ·
 metal, czarny mat, wewnątrz złoty, drewno

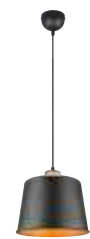

Pendelleuchte · Pendant
 ↑ 150 cm, Ø 26 cm
 excl. 1 x E27, max. 60 W



312700132



Pendelleuchte · Pendant
 ↑ 150 cm, ↔ 87 cm, Ø 18 cm
 excl. 4 x E27, max. 40 W



312700432



Stehleuchte · Floor lamp
 ↑ 156 cm, ↗ 75 cm, Ø 26 cm
 excl. 1 x E27, max. 60 W



412700132





Wandleuchte · Wall lamp
↔ 9 x 13,7 cm, ↗ 19,5 cm
excl. 1 x E14, max. 15 W



804370132



Deckenleuchte · Ceiling lamp
↔ 26 x 9 cm, ↓ 19,5 cm
excl. 2 x E14, max. 15 W



804370232



Deckenleuchte · Ceiling lamp
↔ 44 x 9 cm, ↓ 19,5 cm
excl. 3 x E14, max. 40 W



804300332



Deckenleuchte · Ceiling lamp
↔ 22 x 22 cm, ↓ 19,5 cm
excl. 4 x E14, max. 40 W



804300432



Pendelleuchte · Pendant
Ø 10 cm, ↓ 150 cm
excl. 1 x E27, max. 40 W



304300132



Pendelleuchte · Pendant
↔ 65 x 9 cm, ↓ 150 cm
excl. 4 x E27, max. 40 W



304300432



TOSH

Metall, Schwarz matt, Holz · metal, black mat, wood ·
metale, noir mat, bois · metaal, mat zwart, hout · metal, estera negra, madera ·
metallo, nero opaco, di legno · metal, negru mat, lemn · metalli, mattamusta, puu ·
metal, czarny mat, drewno

Empfohlen:
recommended: Filament LED E14,
4 W,
470 lm, 3.000 K



983-400



Pendelleuchte · Pendant
Ø 28 cm, ↓ 150 cm
excl. 3 x E27, max. 40 W



304330332



Stehleuchte · Floor lamp
↓ 150 cm, Ø 23 cm
excl. 3 x E14, max. 15 W



404300332



Tischleuchte · Table lamp
↓ 40 cm, ↔ 15 x 18 cm
excl. 1 x E14, max. 15 W



504300132



Empfohlen:
recommended: Filament LED E27, 8 W
806 lm, 2.700 K



987-6810

MADRAS

silberfarbig antik, Holz · antique silver, wood ·
argent antique, bois · antiek zilver, hout · plateado antiguo, madera · argento anticato, di legno ·
argint antic, lemn · antiikkihopea, puu · antyczne srebro, drewno · gümüş antika, tahta



Wandleuchte · Wall lamp
↑ 23 x 14 cm, ↗ 14 x 17 cm
excl. 1 x E27, max. 28 W



805300188



Deckenleuchte · Ceiling lamp
↔ 30 x 14 cm, ↑ 28 cm
excl. 2 x E27, max. 28 W



805300288



Deckenleuchte · Ceiling lamp
↔ 60,5 x 14 cm, ↑ 28 cm
excl. 3 x E27, max. 28 W



805300388



Deckenleuchte · Ceiling lamp
↔ 80 x 14 cm, ↑ 28 cm
excl. 4 x E27, max. 28 W



805300488



PLANT

Nickel antik, Sisal · nickel antique, Sisal ·
nickel antique, Sisal · antiek nikkel, Sisal ·
níquel antiguo, Sisal · nickel anticato, Sisal ·
nichel antic, Sisal · antiikkiteräs, Sisal ·
aikiel antyczny, Sisal

Deko-Pflanze nicht enthalten! · Decoration not included! ·
Décoration non incluse! · Decoratie niet inbegrepen! ·
Decoración no incluida. · Decorazione non inclusa! ·
Decorația nu este inclusă! · Koristus ei sisälly! ·
Nie zawiera dekoracji!

Empfohlen:
recommended: Filament LED E27, 4 W
470 lm, 2.700 K



987-400



92945



Pendelleuchte · Pendant
↔ 115 x 22 cm, ↑ 150 cm
excl. 3 x E27, max. 40 W



301000367

JUDITH

Glas klar · clear glass ·
verre claire · helder glas ·
vidrio claro · vetro chiaro ·
sticlă transparentă · kirkas lasi ·
przezroczyste szkło



Pendelleuchte · Pendant
Ø 24,5 cm, † 150 cm
excl. 1 x E27, max. 60 W



302900102

Empfohlen:
recommended: Filament LED E27, 6 W
420 lm, 2.700 K



987-679



ROPE

Metall, Altmessing · metal, old brass ·
metale, laiton fumé · metaal, oud brons · metal, bronze
viejo · metallo, ottone invecchiato · metal, bronz antic ·
metalli, antiikkimessinki · metal, patyna

Empfohlen:
recommended: Filament LED E27, 7 W
806 lm, 3.000 K



988-600

Filament LED E27, 6 W
660 lm, 2.700 K



988-679



Pendelleuchte · Pendant
Ø 12 cm, † 150 cm
excl. 1 x E27, max. 60 W



310100104

Pendelleuchte · Pendant
Ø 12 cm, † 150 cm
excl. 2 x E27, max. 60 W



310100204



BOOLAN

Holz · wood ·
bois · hout · madera · di legno ·
lemn · puu · drewno

Empfohlen:
recommended: Filament LED E27, 7 W
806 lm, 3.000 K



988-600



26 | Braun · brown



30 | holzfarbig hell · light colored wood

Pendelleuchte · Pendant
Ø 50 cm, † 150 cm
excl. 1 x E27, max. 60 W



305900126
305900130





Pendelleuchten & Kronen

Pendants & chandeliers
Lustres & suspensions
Hanglampen & kroonluchters
Colgantes y Lámparas
Lampadari e sospensioni
Lustre si pendule
Riippu- & kruunu
Wiszące i żyrandole



05 | Aluminium gebürstet · brushed aluminium



32 | Schwarz matt · black mat



65 | Coffee · coffee

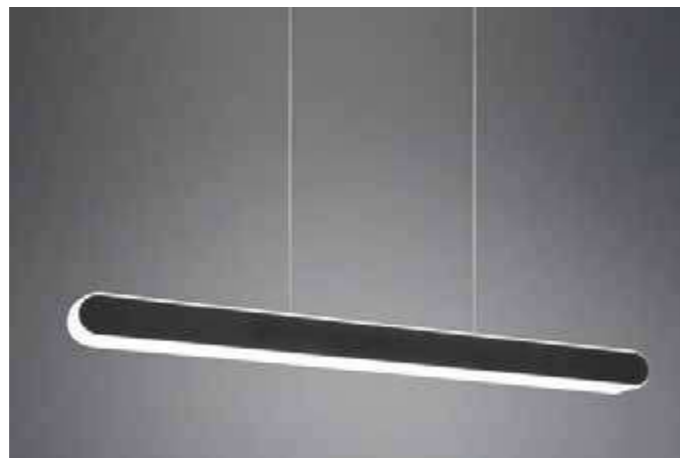

Pendelleuchte · Pendant
 ↔ 82,5 - 130 cm, ↓ 150 cm
 incl. SMD-LED, 48 W
 5.800 lm, 2.700 - 6.500 K



343310305
 343310332
 343310365

HELIOS

Metall · metal ·
 metale · metaal · metal · metallo · metal · metalli · metal

Lichtfarbe stufenlos einstellbar ·
 Light color infinitely variable

4 fach TOUCH ·
 4 level Touch function

Ausziehbar · Extendible · extensible · Verlengbaar ·
 Extensibile · Estensibile · extensibil · Jatkettava · Rozsuwalny

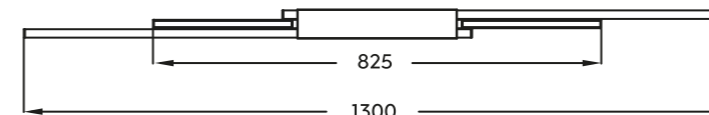



Pendelleuchte · Pendant
 ↔ 95 - 150 cm, ↓ 95 - 150 cm
 incl. SMD-LED, 45 W, 5.300 lm
 incl. 2 x SMD-LED, 6 W, 2 x 500 lm
 2.700 - 5.000 K



- 375310502
- 375310505
- 375310507
- 375310508
- 375310532



- 02** | Schwarz / Messing matt · black / brass mat
- 05** | Aluminium gebürstet · brushed aluminium
- 07** | Nickel matt · nickel mat
- 08** | Messing matt · brass mat
- 32** | Schwarz matt · black mat

TRAJAN

Metall · metal ·
 metals · metaal · metal · metallo · metal · metalli · metal

 Lichtfarbe stufenlos einstellbar ·
 Light color infinitely variable

 4 fach TOUCH ·
 4 level Touch function

Ausziehbar · Extendible · extensible · Verlengbaar ·
 Extensibile · Estensibile · extensibil · Jatkettava · Rozsuwalny

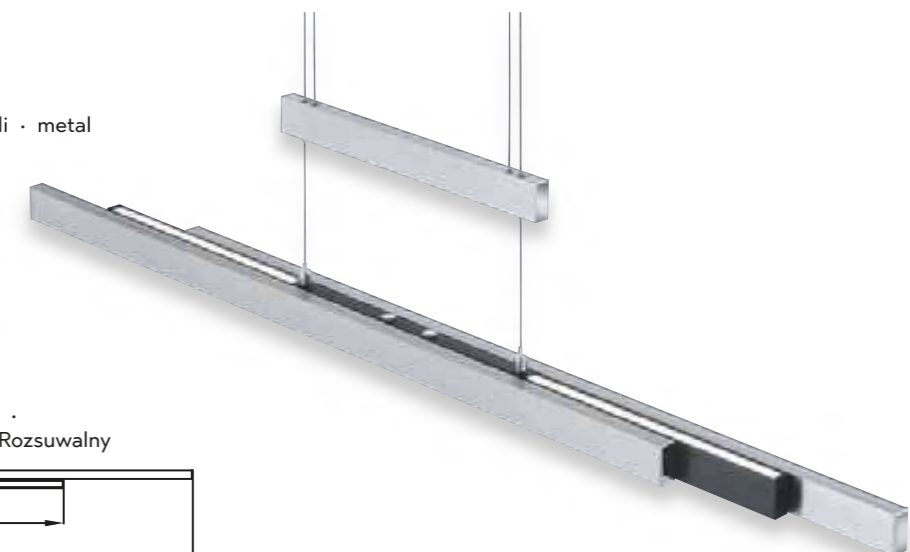
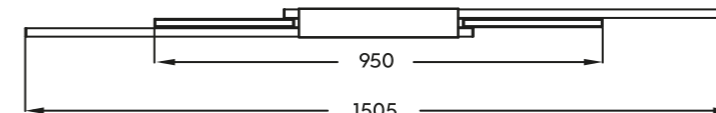



LACAL

Nickel matt oder goldfarbig · nickel mat or gold ·
 nickel mat ou or · nikkell mat of goud · níquel mate o oro ·
 nichel opaco o oro · nichel mat sau aur · harjattu teräs tai kultaa · nikiel mat lub złota

Gibt Licht nach oben und unten · up and down lighting ·
 point lumineux en haut et en bas · lichtpunt boven en onder · luz de arriba y abajo ·
 luce su e giù · sus și în jos lumina · ylös ja alas valoa · w górę iw dół światło

 Lichtfarbe einstellbar ·
 Adjustable light color

 4 fach TOUCH ·
 4 level Touch function

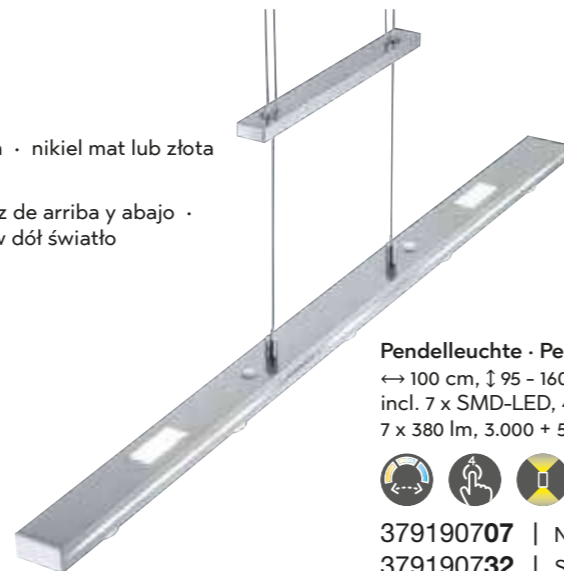

Pendelleuchte · Pendant
 ↔ 100 cm, ↑ 95 - 160 cm
 incl. 7 x SMD-LED, 4 W
 7 x 380 lm, 3.000 + 5.000 K



379190707 | Nickel matt · nickel mat
 379190732 | Schwarz matt · black mat

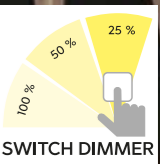

BELFAST

Metall, Nickel matt oder Schwarz matt · metal, nickel mat or black mat ·
 metale, nickel mat ou noir mat · metaal, nikkell mat of mat zwart ·
 metal, níquel mate o estera negra · metallo, nichel opaco o nero opaco ·
 metal, nichel mat sau negru mat · metalli, harjattu teräs tai mattamusta ·
 metal, nikiel mat lub czarny mat

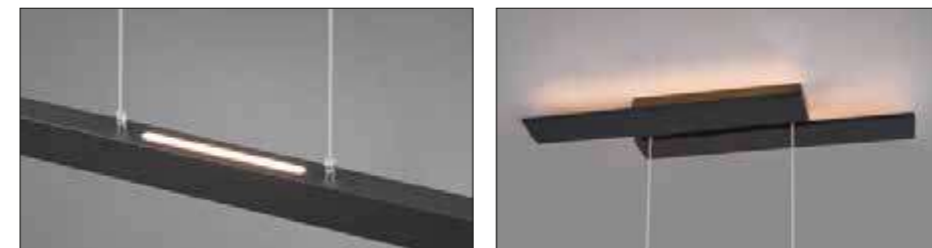

Gibt Licht nach oben und unten · up and down lighting ·
 point lumineux en haut et en bas · lichtpunt boven en onder · luz de arriba y abajo ·
 luce su e giù · sus și în jos lumina · ylös ja alas valoa · w górę iw dół światło



Pendelleuchte · Pendant
 ↔ 115,5 x 14,2 cm, ↑ 150 cm
 incl. SMD-LED, 45 W
 5.300 lm, 3.000 K



375510407 | Nickel matt · nickel mat
 375510432 | Schwarz matt · black mat

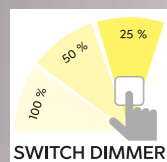

MERTON

Nickel matt oder Messing matt, Glas Weiß · nickel mat or brass mat, glass white ·
 nickel mat ou laiton mat, verre blanc · nikkell mat of messing mat, glas wit · níquel mate o bronze mate, vidrio blanco ·
 nichel opaco o ottone satinato, vetro bianco · nichel mat sau bronz mat, sticla alb ·
 afstandsbediening tai geïntegreerde dimmer, lasi schakelaar · nikiel mat lub mosiądz mat, szkło biały

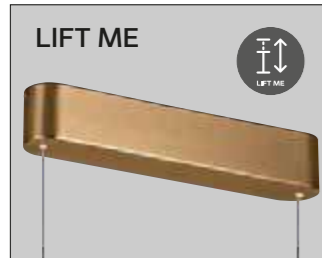

Innovative Höhenverstellung ohne Gegengewicht ·
 Innovative height adjustment without counterweight ·
 Nouveau! Réglage de la hauteur sans contrepoids ·
 Innovatieve hoogteverstelling zonder contragewicht ·
 Innovador sistema de ajuste de altura sin necesidad de
 contrapeso · Regolazione innovativa dell'altezza senza
 contrappeso · Ajustare inovativa a inaltimii fara
 contragreutate · Innoatiivinen korkeuden säätö ilman
 vastapainoa · Innowacyjna regulacja wysokości bez
 przeciwwagi

Pendelleuchte · Pendant
 ↔ 102 x 11 cm, ↓ 80 - 150 cm
 incl. 3 x SMD-LED, 9 W
 3 x 950 lm, 3.000 K



343610307 | Nickel matt · nickel mat
 343610308 | Messing matt · brass mat

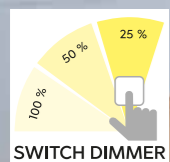

AICK

Metall, Aluminium gebürstet oder Schwarz matt · metal, brushed aluminium or black mat · metale, aluminium balayé ou noir mat · metaal, geborsteld aluminium of mat zwart · metal, aluminio pulido o estera negra · metallo, alluminio spazzolato o nero opaco · metal, aluminiu lucios sau negru mat · metalli, harjattu alumiini tai mattamusta · metal, aluminium szczotkowane lub czarny mat

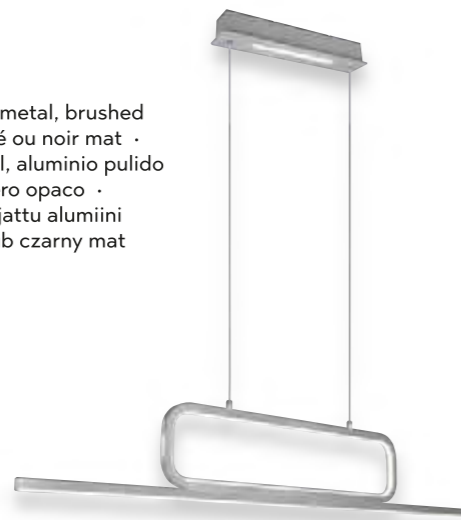

Pendelleuchte · Pendant
 ↔ 110 x 7,5 cm, ↓ 150 cm
 incl. SMD-LED, 38 W
 4.500 lm, 3.000 K



327210305 | Aluminium gebürstet · brushed aluminium
 327210332 | Schwarz matt · black mat



GRANT

Aluminium gebürstet oder Messing matt, Schwarz matt · brushed aluminium or brass mat, black mat · aluminium balayé ou laiton mat, noir mat · geborsteld aluminium of messing mat, mat zwart · aluminio pulido o bronce mate, estera negra · lluminio spazzolato o ottone satinato, nero opaco · aluminiu lucios sau bronz mat, negru mat · harjattu alumiini tai mattamessinki, mattamusta · aluminium szczotkowane lub mosiądz mat, czarny mat

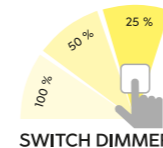
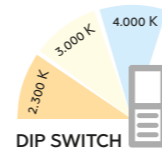

Pendelleuchte · Pendant
 ↔ 138 x 12 cm, ↓ 150 cm
 incl. SMD-LED, 54 W
 6.500 lm, 2.300 + 3.000 + 4.000 K



342710205 | Aluminium gebürstet · brushed aluminium
 342710208 | Messing matt · brass mat

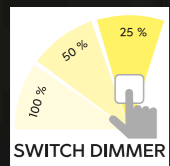

TUBULAR

Metall, Weiß matt oder Schwarz matt · metal, white mat or black mat ·
 metale, blanc mat ou noir mat · metaal, wit mat of mat zwart ·
 metal, estera blanca o estera negra · metallo, bianco opaco o nero opaco ·
 metal, alb mat sau negru mat · metalli, valkoinen matto tai musta matto ·
 metal, biały mat lub czarny mat



31 | Weiß matt · white mat

32 | Schwarz matt · black mat



Pendelleuchte · Pendant
 Ø 40 cm, ↑ 150 cm
 incl. 11 x SMD-LED, 2,8 W
 11 x 350 lm, 3.000 K



321691131
 321691132

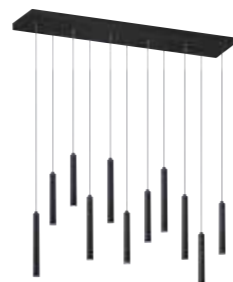

Pendelleuchte · Pendant
 ↔ 115 x 15 cm, ↑ 150 cm
 incl. 11 x SMD-LED, 2,8 W
 11 x 350 lm, 3.000 K



321611131
 321611132

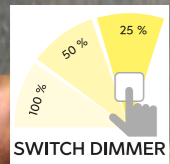

SWITCH DIMMER

CURL

Metall, Weiß matt · metal, white ·
 metale, blanc mat · metaal, wit mat · metal, estera blanca ·
 metallo, bianco opaco · metal, alb mat · metalli, mattavalkoinen ·
 metal, biały mat



4.000 Kelvin

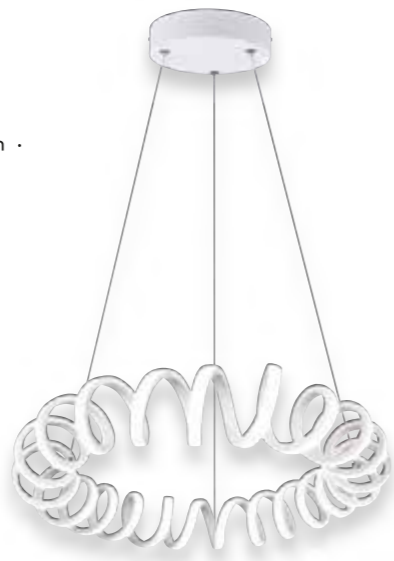

Pendelleuchte · Pendant
 Ø 55 cm, ↑ 150 cm
 incl. SMD-LED, 33 W
 5.000 lm, 4.000 K



325110131

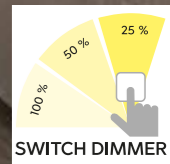

SWITCH DIMMER

DURBAN

Metall, Nickel matt oder Anthrazit · metal, nickel mat or anthracite ·
 metale, nickel mat ou antracite · metaal, nikkel mat of antraciet ·
 metal, níquel mate o antracita · metallo, nichel opaco o antracite ·
 metal, nichel mat sau antracit · metalli, harjattu teräs tai antrasiitti ·
 metal, nikiel mat lub antracyt

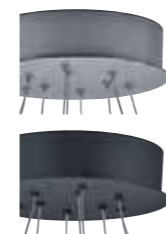

07 | Nickel matt · nickel mat

42 | Anthrazit · anthracite

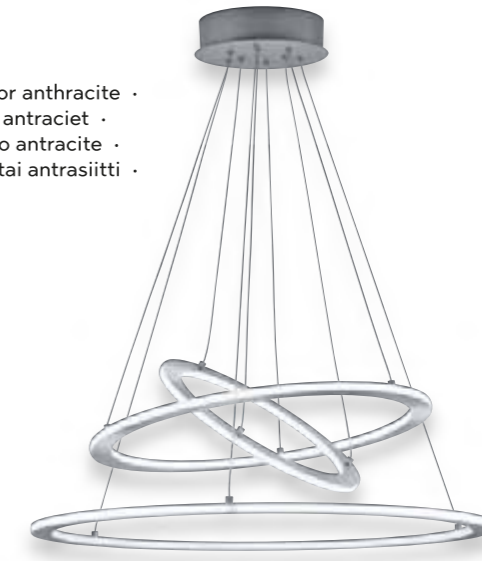

Pendelleuchte · Pendant
 Ø 80,3 cm, ↑ 200 cm
 incl. SMD-LED, 75 W
 8.900 lm, 3.000 K





321910307
 321910342



MARLEY

Metall · metal ·
metale · metaal · metal · metallo ·
metal · metalli · metal · metal

-  **01** | Weiß · white
-  **07** | Nickel matt · nickel mat
-  **31** | Weiß matt · white mat
-  **32** | Schwarz matt · black mat

Empfohlen:
recommended: LED GU10, 4,5 W
345 lm, 3.000 K



956-55



Pendelleuchte · Pendant
↑ 150 cm, ↔ 12 x 12 cm, Ø 6 cm
excl. 1 x GU10, max. 35 W



312400101
312400107
312400132

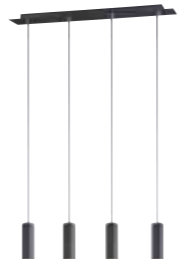

Pendelleuchte · Pendant
↔ 75 x 9 cm, ↑ 150 cm
excl. 4 x GU10, max. 35 W



312400401
312400407
312400432

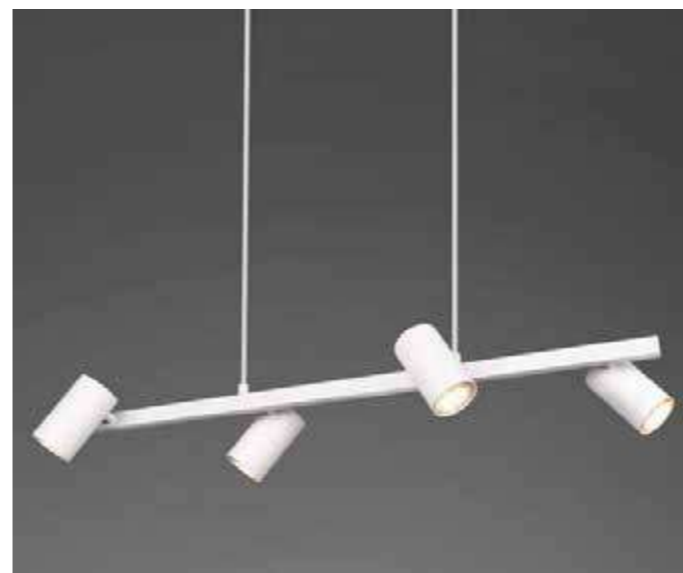

Pendelleuchte · Pendant
↔ 80 x 18 cm, ↑ 150 cm
excl. 4 x GU10, max. 35 W



302400407
302400431
302400432



Pendelleuchte · Pendant
↔ 115 x 20 cm, ↑ 150 cm
excl. 6 x GU10, max. 35 W



302400607
302400631
302400632



MARLEY

Metall, Altmessing oder Schwarz-Gold · metal, old brass or black-gold ·
 métal, laiton fumé ou noir et or · metaal, oud brons of zwart-goud ·
 metal, bronce viejo o negro-oro · metallo, ottone invecchiato o oro nero ·
 metal, bronz antic sau negru-auriu · metalli, antiikkimessinki tai musta-kulta ·
 metal, patyna lub czarno złoty

Empfohlen:
 recommended: LED GU10, 4,5 W
 345 lm, 3.000 K



956-55



04 | Altmessing ·
 old brass



80 | Schwarz-Gold ·
 black-gold



Pendelleuchte · Pendant
 ↔ 80 x 18 cm, ↑ 150 cm
 excl. 4 x GU10, max. 35 W



302400404
 302400480



Pendelleuchte · Pendant
 ↔ 115 x 20 cm, ↑ 150 cm
 excl. 6 x GU10, max. 35 W



302400604
 302400680



MARLEY

Metall, Holz · metal, wood ·
 Métal, bois · Metaal, hout · Metal, madera ·
 Metallo, di legno · Metal, lemn · Metallii, puu ·
 Metal, drewno



07 | Nickel matt / Holz ·
 nickel mat / wood



31 | Weiß matt / Holz ·
 white mat / wood



32 | Schwarz matt / Holz ·
 black mat / wood

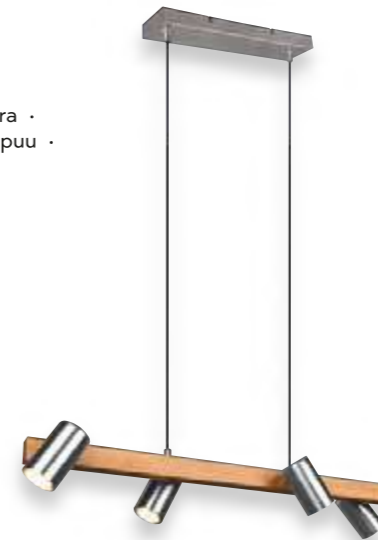

Pendelleuchte · Pendant
 ↔ 80 x 18 cm, ↑ 150 cm
 excl. 4 x GU10, max. 35 W



312490407
 312490431
 312490432



Pendelleuchte · Pendant
 ↔ 115 x 20 cm, ↑ 150 cm
 excl. 6 x GU10, max. 35 W



312490607
 312490631
 312490632



STANLEY

Nickel matt, Glas Weiß oder Schwarz matt, Glas rauchfarbig · nickel mat, glass white or black mat, glass smoke ·
 nickel mat, verre blanc ou noir mat, verre fumé · nikkell mat, glas wit of mat zwart, glas rookkleur ·
 níquel mate, vidrio blanco o estera negra, vidrio humo ·
 nichel opaco, vetro bianco o nero opaco, vetro fume' ·
 nichel mat, sticla alb sau negru mat, sticla fumuriu ·
 afstandsbediening, lasi schakelaar tai mattamusta, lasi savu ·
 nikiel mat, szkło biały lub czarny mat, szkło przydymiony



07 | Nickel matt / Glas Weiß ·
 nickel mat / glass white



Pendelleuchte · Pendant
 ↔ 55 x 19 cm, ↑ 150 cm
 excl. 2 x E27, max. 40 W



319500207
 319500232



Pendelleuchte · Pendant
 ↔ 95 x 19 cm, ↑ 150 cm
 excl. 3 x E27, max. 40 W



319500307
 319500332



CLAYTON

Metall schwarz matt, Glas chrom bedampft · metal black mat, chrome plated glass ·
 métal noir mat, verre plaqué chrome · metaal mat zwart, chroom opgedampt glas ·
 metal estera negra, vidrio cromado · metallo nero opaco, vetro verniciato cromo ·
 metal negru mat, sticla cromata · metalli mattamusta, kromipäällystetty lasi ·
 metal czarny mat, szkło chromowane

Empfohlen:
 recommended: Filament LED E27, 4 W
 470 lm, 2.700 K



987-400



Pendelleuchte · Pendant
 Ø 20 cm, † 150 cm
 excl. 1 x E27, max. 28 W



310300132



Pendelleuchte · Pendant
 Ø 45 cm, † 150 cm
 excl. 3 x E27, max. 28 W



310390332



Pendelleuchte · Pendant
 ↔ 120 cm, † 150 cm
 excl. 5 x E27, max. 28 W



310300532



MELA

Metall, Weiß matt oder Schwarz matt, Glas · metal, white mat or black mat, glass ·
 métal, blanc mat ou noir mat, verre · metaal, wit mat of mat zwart, glas ·
 metal, estera blanca o estera negra, vidrio · metallo, bianco opaco o nero opaco, vetro ·
 metal, alb mat sau negru mat, sticla · metalli, mattavalkoinen tai mattamusta, lasi ·
 metal, biały mat lub czarny mat, szkło

Empfohlen:
 recommended: Filament LED E14, 4 W
 470 lm, 2.700 K



983-400



31 | Weiß matt · white mat



32 | Schwarz matt · black mat



Pendelleuchte · Pendant
 Ø 33 cm, † 150 cm
 excl. 5 x E14, max. 25 W



313100531
 313100532

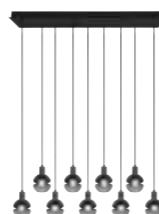

Pendelleuchte · Pendant
 ↔ 102 x 22 cm, † 150 cm
 excl. 9 x E14, max. 25 W



313100931
 313100932



CANDELA

Aluminium gebürstet/Chrom oder Messing matt/Messing poliert · brushed aluminium/chrome or brass mat/polished brass · aluminium balayé/chrome ou laiton mat/laiton polis · geborsteld aluminium/chroom of messing mat/gepolijst messing · aluminio pulido/cromo o bronce mate/bronce · alluminio spazzolato/cromo o ottone satinato/ottone lucido · aluminiu lucios/crom sau bronz mat/bronz · harjattu alumiini/kromi tai mattamessinki/messinki · aluminium szczotkowane/chrom lub mosiądz mat/mosiądz polerowany

Empfohlen:
recommended: Filament LED E14, 4 W
400 lm, 2.700 K



989-479



03 | Messing poliert · polished brass



05 | Aluminium gebürstet · brushed aluminium



Pendelleuchte · Pendant
Ø 56 cm, ↑ 150 cm
excl. 4 x E14, max. 40 W



102000403
102000405



ONTARIO

Glas goldfarbig · glass gold · Verre Or · Glas Goud · Vidrio Oro · Vetro Oro · Sticla Aur · Lasi Kultaa · Szkło Złota



Pendelleuchte · Pendant
↑ 155 cm, Ø 51 cm
excl. 1 x E27, max. 60 W



315200179

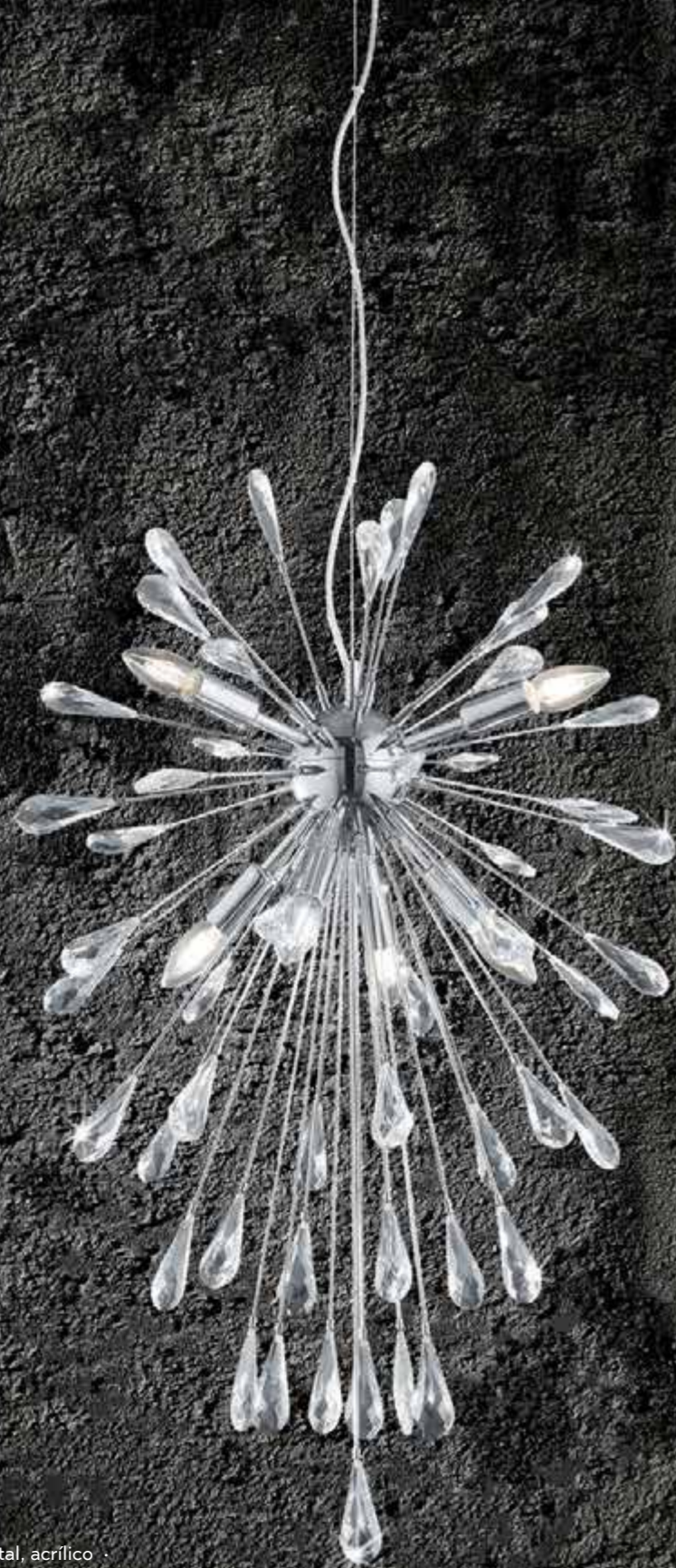

MINSK

Metall, Acryl · metal, acryl ·
metale, acryl · metaal, acryl · metal, acrílico ·
metallo, acrilico · metal, acrilic · metalli, akryyli · metal, akryl

Empfohlen:
recommended: Filament LED E14, 4 W
470 lm, 2.700 K



989-400

Pendelleuchte · Pendant
Ø 50 cm, ↑ max. 150 cm
excl. 7 x E14, max. 28 W



308600706



LUCERNA

Chrom, Acryl · chrome, acryl ·
chrome, acryl · chroom, acryl · cromo, acrílico · cromo, acrilico ·
crom, acrilic · kromi, akryyli · chrom, akryl

Empfohlen:
recommended: Filament LED E14, 4 W
470 lm, 3.000 K



990-400



Lüster · Chandelier
Ø 52 cm, ↑ 150 cm
excl. 5 x E14, max. 40 W



101600506



Lüster · Chandelier
Ø 68,5 cm, ↑ 150 cm
excl. 8 x E14, max. 40 W



101600806



ROMINO II

Metall, Schwarz matt, innen goldfarbig · metal, black mat, gold colored inside ·
 métal, noir mat, or · metaal, mat zwart, binnenkant goudkleur · metal, estera negra, interior en color dorado ·
 metallo, nero opaco, interno colore oro · metal, negru mat, interior culoare aurie ·
 metalli, mattamusta, sisäosa kullanvärinen · metal, czarny mat, wewnątrz złoty

Empfohlen:
 recommended: Filament LED E27, 7 W
 806 lm, 2.700 K



985-6810



Pendelleuchte · Pendant
 Ø 50 cm, ↑ 150 cm
 excl. 1 x E27, max. 60 W



308000132



LORELEY

Chrom, Acryl, Stoffschirm · chrome, acryl, fabric shade ·
 chrome, acryl, abat-jour tissu · chrom, acryl, Stoffen kap ·
 cromo, acrílico, Pantalla de tela · cromo, acrilico, paralume in tessuto ·
 crom, acrilic, abajur textil · kromi, akryyli, kangas varjostin ·
 chrom, akryl, Klosz z materiału

Empfohlen:
 recommended: Filament LED E14, 4 W
 470 lm, 2.700 K



989-400



Pendelleuchte · Pendant
 Ø 50 cm, ↑ 150 cm
 excl. 3 x E14, max. 40 W



309300302



CHIRON

Aluminium, Messing matt, Schwarz matt · aluminium, brass mat, black mat · aluminium, laiton mat, noir mat · aluminium, messing mat, mat zwart · aluminio, bronce mate, estera negra · alluminio, ottone satinato, nero opaco · aluminiu, bronz mat, negru mat · alumiini, mattamessinki, mattamusta · aluminium, mosiądz mat, czarny mat



Pendelleuchte · Pendant
 Ø 20 cm, ↑ 150 cm
 excl. 1 x E27, max. 40 W



310800108



Pendelleuchte · Pendant
 Ø 45 cm, ↑ 150 cm
 excl. 1 x E27, max. 40 W



310890108



Pendelleuchte · Pendant
 ↔ 90 x 20 cm, ↑ 150 cm
 excl. 3 x E27, max. 40 W



310800308



CHIRAZ

Metall, Schwarz matt, goldfarbig · metal, black mat, gold · métal, noir mat, or · metaal, mat zwart, goud · metal, estera negra, oro · metallo, nero opaco, oro · metal, negru mat, aur · metalli, mattamusta, kultaa · metal, czarny mat, złota

Empfohlen:
 recommended: Filament LED E14, 4 W
 470 lm, 2.700 K



983-400



Pendelleuchte · Pendant
 ↔ 63 x 20 cm, ↑ 150 cm
 excl. 3 x E14, max. 25 W



310500332



Pendelleuchte · Pendant
 ↔ 90,5 x 32,5 cm, ↑ 150 cm
 excl. 6 x E14, max. 25 W



310500632



CORTEZ

Metall, weiß matt, Stoffschirm · metal, white mat, fabric shade ·
 metale, blanc mat, abat-jour tissu · metaal, wit mat, Stoffen kap ·
 metal, estera blanca, Pantalla de tela · metallo, bianco opaco, paralume in tessuto ·
 metal, alb mat, abajur textil · metalli, mattavalkoinen, kangas varjostin ·
 metal, biały mat, Klosz z materiału · metal, beyaz mat, Kumaş şapka



Pendelleuchte · Pendant
 Ø 52 cm, ↑ 150 cm
 excl. 3 x E14, max. 28 W



110600331



Pendelleuchte · Pendant
 Ø 70 cm, ↑ 150 cm
 excl. 5 x E14, max. 28 W



110600531

Empfohlen:
 recommended: LED E14, 3,5 W
 320 lm, 3.000 K



989-40



LIVIA

Metall Schwarz matt, goldfarbig · metal black mat, gold ·
 metale noir mat, or · metaal mat zwart, goud · metal estera negra, oro ·
 metallo nero opaco, oro · metal negru mat, aur · metalli musta matto, kultaa ·
 metal czarny mat, złota



Pendelleuchte · Pendant
 Ø 46,8 cm, ↑ 150 cm
 excl. 3 x E14, max. 28 W



101700332



Pendelleuchte · Pendant
 Ø 57,5 cm, ↑ 150 cm
 excl. 5 x E14, max. 28 W



101700532

Empfohlen:
 recommended: Filament LED E14, 4 W
 470 lm, 3.000 K



990-400



FILO

Metall Schwarz matt, Glas Weiß · metal black mat, glass white ·
 metale noir mat, verre blanc · metaal mat zwart, glas wit · metal estera negra, vidrio blanco ·
 metallo nero opaco, vetro bianco · metal negru mat, sticla alb · metalli mattamusta, lasi valkoinen ·
 metal czarny mat, szkło biały

Empfohlen:
 recommended: LED E27, 10 W
 806 lm, 3.000 K



988-10



Pendelleuchte · Pendant
 ↑ 150 cm, Ø 40 cm
 excl. 1 x E27, max. 60 W



313900132



FLETCHER

Metall, schwarz matt · metal, black mat ·
 metale, noir mat · metaal, mat zwart · metal, estera negra ·
 metallo, nero opaco · metal, negru mat · metalli, mattamusta · metal, czarny mat

Empfohlen:
 recommended: Filament LED E14, 4 W
 470 lm, 2.700 K



983-400



Pendelleuchte · Pendant
 ↔ 105 x 15 cm, ↑ 150 cm
 excl. 4 x E14, max. 40 W



313300432



ZUCCA

Chrom, Acryl · chrome, acryl ·
chrome, acryl · chroom, acryl · cromo, acrílico ·
cromo, acrílico · crom, acrilic · kromi, akryyli · chrom, akryl

 00 | Transparent · transparent

 06 | Chrom · chrome

Empfohlen:
recommended: Filament LED E27, 7 W
806 lm, 2.700 K



985-6810

Pendelleuchte · Pendant
Ø 40 cm, ↑ 150 cm
excl. 1 x E27, max. 60 W



304100100
304100106



SANNA

Metall · metal ·
metale · metaal · metal · metallo · metal · metalli · metal

 01 | Weiß · white

 02 | Schwarz · black

Empfohlen:
recommended: Filament LED E27, 7 W
806 lm, 3.000 K



987-600

Empfohlen:
recommended: Filament LED E27, 6 W
600 lm, 2.700 K



987-679



Pendelleuchte · Pendant
Ø 25 cm, ↑ 150 cm
excl. 1 x E27, max. 60 W



300900101
300900102



ONYX

Metall, Anthrazit, innen goldfarbig · metal, anthracite, gold colored inside ·
 metale, antracite, Or · metaal, antraciet, Binnenkant goudkleur ·
 metal, antracita, Interior en color dorado ·
 metallo, antracite, interno colore oro ·
 metal, antracit, interior culoare aurie ·
 metalli, antrasiitti, sisäosa kullanvärinen ·
 metal, antracyt, wewnątrz złoty



Pendelleuchte · Pendant
 Ø 15 cm, † 150 cm
 excl. 1 x E27, max. 42 W



301300142



Pendelleuchte · Pendant
 Ø 35 cm, † 150 cm
 excl. 3 x E27, max. 42 W



301300342



Pendelleuchte · Pendant
 ↔ 90 x 15 cm, † 150 cm
 excl. 4 x E27, max. 42 W



301300442

Empfohlen:
 recommended: Filament LED E27, 4 W
 470 lm, 2.700 K



987-400



JASMIN

Metall · metal ·
metale · metaal · metal · metallo ·
metal · metalli · metal

Empfohlen:
recommended: Filament LED E14, 4 W
470 lm, 2.700 K



989-400



04 | Altmessing · old brass



62 | kupferfarbig antik · copper-coloured antique

Pendelleuchte · Pendant
Ø 19 cm, ↓ 150 cm
excl. 1 x E14, max. 40 W



303700104
303700162



CORD

Kupfer antik, Stoffkabel · antique copper, fabric sheathed cable ·
cuivre ancien, câble gainé de tissu · antiek koper, kabel met
stofmantel · cobre antiguo, cable forrado de tela · rame antico,
cavo rivestito in tessuto · cupru antic, țesătură din fibră de sticlă ·
antiikki kupari, kangaspäällysteinen kaapeli · antyczne miedzi,
kabel z osłoną z tkaniny

Empfohlen · recommended:
Filament LED E27, 4 W, 360 lm, 2.700 K



901-479



902-479



903-479



904-479



Pendelleuchte · Pendant
↓ 150 cm, ↔ max. 180 cm
excl. 5 x E27, max. 60 W



310100562



LEVISTO

Nickel matt oder Messing matt, Glas alabasterfarbig · nickel mat or brass mat, alabaster-coloured glass · nickel mat ou laiton mat, verre couleur albâtre · nikkel mat of messing mat, albastkleurig glas · níquel mate o bronze mate, vidrio de color alabastro · nichel opaco o ottone satinato, vetro colore alabastro · nichel mat sau bronz mat, sticla culoare alabastru · harjattu teräs tai mattamessinki, lasi alabasteri väri · nikiel mat lub mosiądz mat, szkło alabaster kolor



Pendelleuchte · Pendant
↔ 60,5 cm, ↓ 95 - 160 cm
incl. 3 x LED E14, 5 W
3 x 400 lm, 3.000 K



371010307
371010308



Pendelleuchte · Pendant
↔ 80 cm, ↓ 95 - 160 cm
incl. 4 x LED E14, 5 W
4 x 400 lm, 3.000 K



371010407
371010408

incl.
LED E14, 5 W
400 lm, 3.000 K



983-60

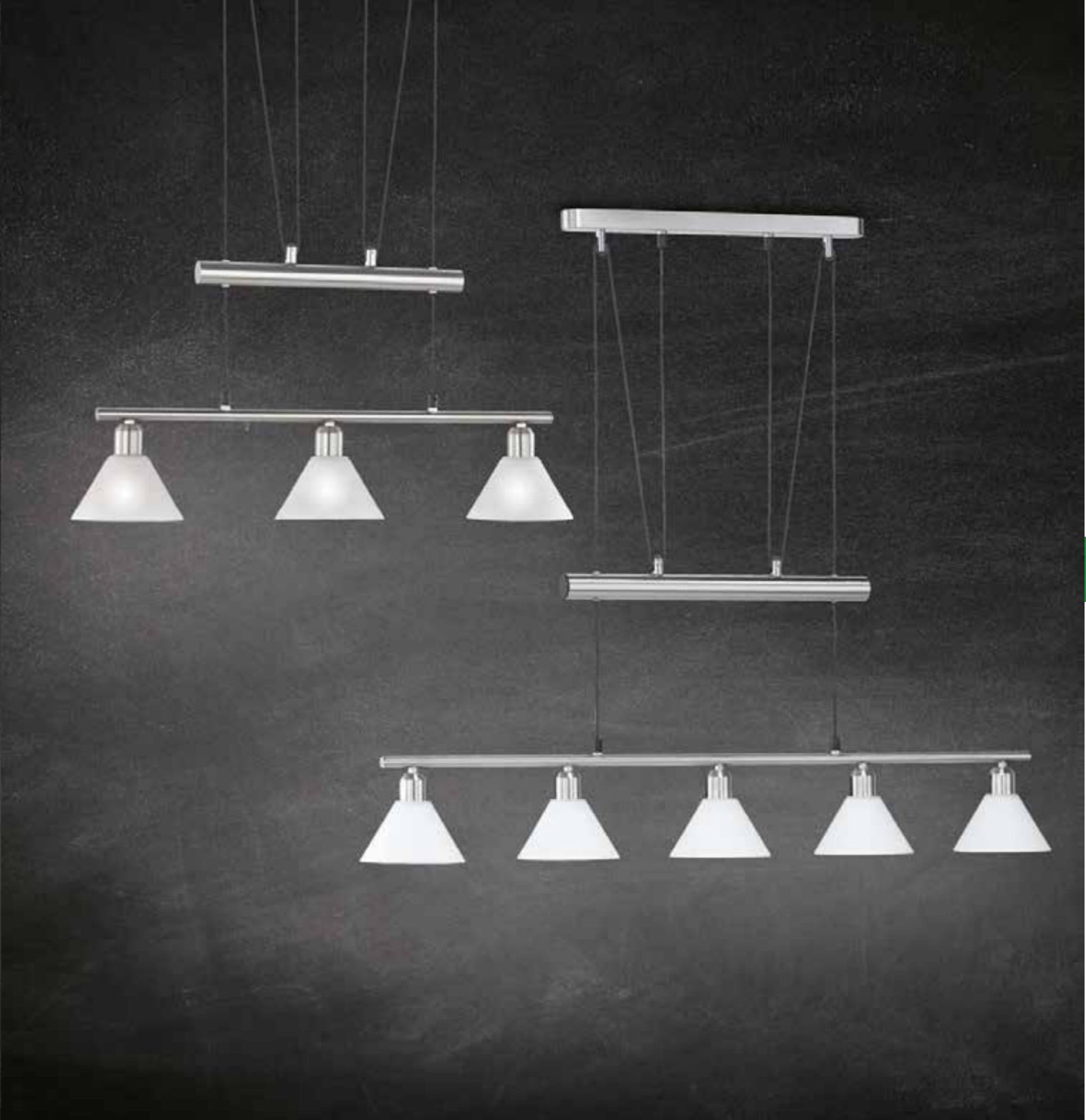

STAMINA

Nickel matt, Glas matt · nickel mat, mat glass · nickel mat, verre mat · nikkel mat, mat glas · níquel mate, vidrio mate · nichel opaco, vetro sabbaiato · nichel mat, sticla mata · harjattu teräs, mattalasi · nikiel mat, szkło matowane

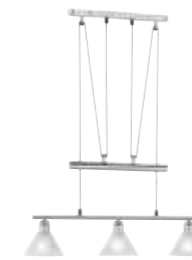

Pendelleuchte · Pendant
↔ 66 x 14 cm, ↓ 80 - 180 cm
excl. 3 x E14, max. 40 W



3751031-07

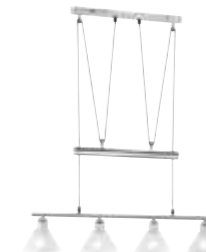

Pendelleuchte · Pendant
↔ 80 x 14 cm, ↓ 80 - 180 cm
excl. 4 x E14, max. 40 W



3751041-07



Pendelleuchte · Pendant
↔ 102 x 14 cm, ↓ 80 - 180 cm
excl. 5 x E14, max. 40 W



3751051-07

Empfohlen:
recommended: LED E14, 3,5 W
320 lm, 3.000 K



983-40

PAPER

Papier, Weiß · paper, white ·
papier, blanc · papier, wit · papel, blanco ·
carta, bianco · hartie, alb · paperi, valkoinen · papier, biały



Pendelleuchte · Pendant
Ø 40 cm
excl. 1 x E27, max. 60 W
VE / moq: 25



3490400-00



260



↑ 73,5 cm
excl. 1 x E27, max. 60 W
VE / moq: 25



3590010-01

DIEGO

Kunststoff, Weiß, Glas · plastic, white, glass ·
Plastique, Blanc, Verre · Kunststof, Wit, Glas ·
Plástico, Blanco, Vidrio · Plastica, Bianco, Vetro ·
Plastic, Alb, Sticla · Muovi, Valkoinen, Lasi ·
Plastik, Biały, Szkło

Empfohlen:
recommended: LED E27, 5 W
400 lm, 3.000 K



986-60



Pendelleuchte · Pendant
Ø 30 cm, ↑ 125 cm
excl. 1 x E27, max. 40 W



301400101

VIOLA

Glas alabasterfarbig · alabaster-coloured glass ·
verre couleur albâtre · albastkleurig glas · vidrio de color alabastro ·
vetro colore alabastro · sticla culoare alabastru · lasi alabasteri väri ·
szkło alabaster kolor

Empfohlen:
recommended: LED E27, 10 W
806 lm, 3.000 K



988-110



Pendelleuchte · Pendant
Ø 38,5 cm, ↑ 70 - 130 cm
excl. 1 x E27, max. 40 W



301700107 | Nickel matt · nickel mat
301700108 | Messing matt · brass mat

261



Wand- & Deckenleuchten

Wall- & Ceiling lamps
Plafonniers & appliques
Wandlampen & plafonnières
Appliques y plafones
Applique e plafoniere
Plafoniere si aplice
Seinä- & katto
Sufitowe i ścienne



2.300 K 3.000 K 4.000 K



DIP SWITCH

Lichtfarben direkt an der Leuchte einstellbar · Colours directly adjustable at the lamp · Les couleurs de la lumière peuvent être réglées directement sur le luminaire · Lichtkleuren direct instelbaar op de lamp · Tonalidades de luz ajustables directamente en la lámpara · Colori della luce regolabili direttamente sulla lampada · Culori ale luminii reglabile direct de la bec · Valon väri asetettävissa suoraan valaisimesta · Barwy światła można ustawić bezpośrednio na oprawie



ZODIAC

Metall, Nickel matt oder Schwarz matt, Coffee · metal, nickel mat or black mat, coffee · métal, nickel mat ou noir mat, café · metaal, nikkel mat of mat zwart, koffie · metal, níquel mate o estera negra, café · metallo, nichel opaco o nero opaco, caffè · metal, nichel mat sau negru mat, cafea · metalli, afstandsbediening tai mattamusta, kahvi · metal, nikiel mat lub czarny mat, kawa

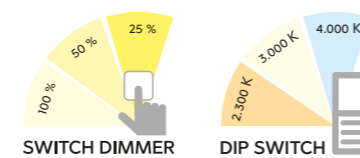

Deckenleuchte · Ceiling lamp
Ø 50 cm, ↓ 10 cm
incl. SMD-LED, 42 W
5.100 lm, 2.300 + 3.000 + 4.000 K



644810107 | Nickel matt · nickel mat
644810132 | Schwarz matt · black mat



 **DIP SWITCH**

Lichtfarben direkt an der Leuchte einstellbar · Colours directly adjustable at the lamp ·
Les couleurs de la lumière peuvent être réglées directement sur le luminaire ·
Lichtkleuren direct instelbaar op de lamp · Tonalidades de luz ajustables directamente en la lámpara ·
Colori della luce regolabili direttamente sulla lampada · Colori ale luminii reglabile direct de la bec ·
Valon väri asetettävissa suoraan valaisimesta · Barwy światła można ustawić bezpośrednio na oprawie

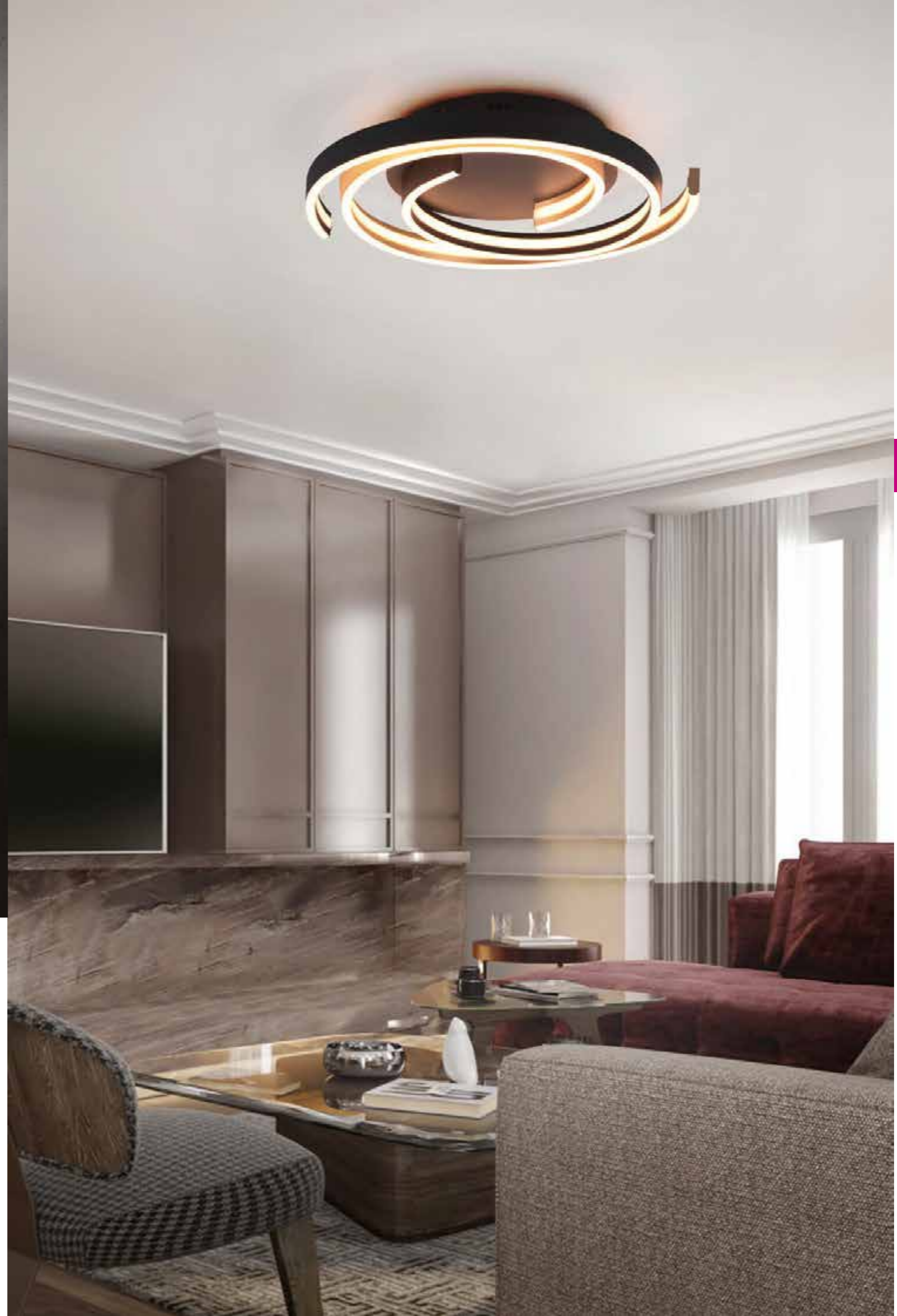

CAYA

Aluminium gebürstet oder Messing matt, Schwarz matt · brushed aluminium or brass mat, black mat ·
Aluminium balayé ou Laiton mat, Noir mat · Geborsteld aluminium of Messing mat, Mat zwart ·
Aluminio pulido o Bronce mate, Estera negra · Alluminio spazzolato o Ottone satinato, Nero opaco ·
Aluminiu lucios sau Bronz mat, Negru mat · Harjattu alumiini tai Mattamessinki, mattamusta ·
Aluminium szczotkowane lub Mosiądz mat, Czarny mat

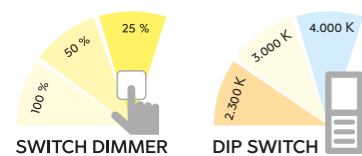

05 | Aluminium gebürstet / Schwarz matt ·
brushed aluminium / black mat

08 | Messing matt / Schwarz matt ·
brass mat / black mat

Deckenleuchte · Ceiling lamp
Ø 50 cm, ↓ 9 cm
incl. SMD-LED, 58 W
6.800 lm, 2.300 + 3.000 + 4.000 K



641910205
641910208

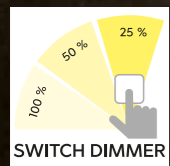

LUGO

Metall, Schwarz matt, goldfarbig · metal, black mat, gold ·
 Métal, Noir mat, Or · Metaal, Mat zwart, Goud · Metal, Estera negra, Oro · Metallo, Nero opaco, Oro ·
 Metal, Negru mat, Aur · Metalli, mattamusta, Kultaa · Metal, Czarny mat, Złota



Wandleuchte · Wall lamp
 ↔ 29 x 29 cm, ↑ 6,5 cm
 incl. SMD-LED, 12 W
 1.450 lm, 3.000 K



242910180



Deckenleuchte · Ceiling lamp
 ↔ 52,5 x 54 cm, ↑ 10 cm
 incl. SMD-LED, 28 W
 3.400 lm, 3.000 K



642910280



Deckenleuchte · Ceiling lamp
 ↔ 74 x 74 cm, ↑ 13 cm
 incl. SMD-LED, 50 W
 6.150 lm, 3.000 K



642910380





Deckenleuchte · Ceiling lamp
 ↔ 59 x 43 cm, ↑ 8,5 cm
 incl. SMD-LED, 29 W
 2.650 lm, 3.000 K

 673810206
 673810232



Deckenleuchte · Ceiling lamp
 ↔ 85 x 60 cm, ↑ 8,5 cm
 incl. SMD-LED, 36 W
 3.250 lm, 3.000 K

 673890206
 673890232



06 | Chrom · chrome



32 | Schwarz matt · black mat

GRANADA

Chrom, Weiß matt oder Schwarz matt, goldfarbig · chrome white mat, or black mat, gold ·
 chrome blanc mat, ou noir mat, or · chroom wit mat, of mat zwart, goud ·
 cromo estera blanca, o estera negra, oro · cromo bianco opaco,
 o nero opaco, oro · crom alb mat, sau negru mat, aur ·
 kromi mattavalkoinen, tai mattamusta, kultaa ·
 chrom biały mat, lub czarny mat, złota

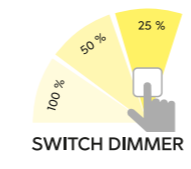

Deckenleuchte · Ceiling lamp
 ↔ 71,5 x 63,5 cm, ↑ 10,5 cm
 incl. SMD-LED, 36 W
 4.300 lm, 3.000 K

 673810306
 673810332



07



32



65



06

MONTILLA

Metall, Acryl · metal, acryl ·
 metale, acryl · metaal, acryl · metal, acrílico ·
 metallo, acrilico · metal, acrilic · metalli, akryyli · metal, akryl

 Lichtfarbe stufenlos einstellbar ·
 Light color infinitely variable

 Integrierter Dimmer ·
 Integrated dimmer

 Memory Funktion ·
 Memory function

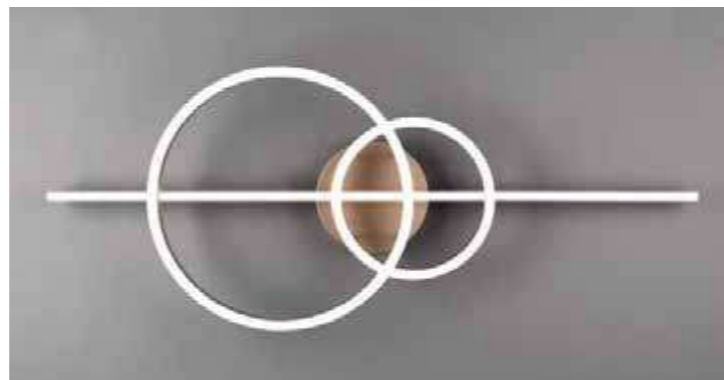

Kistalleffekt ·
 crystal effect

Deckenleuchte · Ceiling lamp
 ↔ 100 x 40 cm, ↑ 12,5 cm
 incl. SMD-LED, 54 W
 6.300 lm, 2.700 - 6.000 K



643010306 | Chrom · chrome
 643010307 | Nickel matt · nickel mat
 643010332 | Schwarz matt · black mat
 643010365 | Coffee · coffee

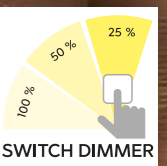
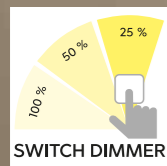

GROOVY

Metall, Kristallglas · metal, crystalglass ·
métal, cristalverre · metaal, kristalglas · metal, cristalvidrio ·
metallo, cristallovetro · metal, cristalsticla · metalli, kristallilasi · metal, kryształszkło



Deckenleuchte · Ceiling lamp
Ø 62,5 cm, ↑ 6 cm
incl. SMD-LED, 30 W
3.800 lm, 4.000 K



642110331



Deckenleuchte · Ceiling lamp
↔ 95,5 x 40 cm, ↑ 6,5 cm
incl. SMD-LED, 37 W
4.800 lm, 4.000 K



642110431



Deckenleuchte · Ceiling lamp
Ø 62,5 cm, ↑ 6 cm
incl. SMD-LED, 30 W
3.600 lm, 3.000 K



642110332



Deckenleuchte · Ceiling lamp
↔ 95,5 x 40 cm, ↑ 6,5 cm
incl. SMD-LED, 37 W
4.600 lm, 3.000 K



642110432



31 | Weiß matt · white mat



32 | Schwarz matt · black mat



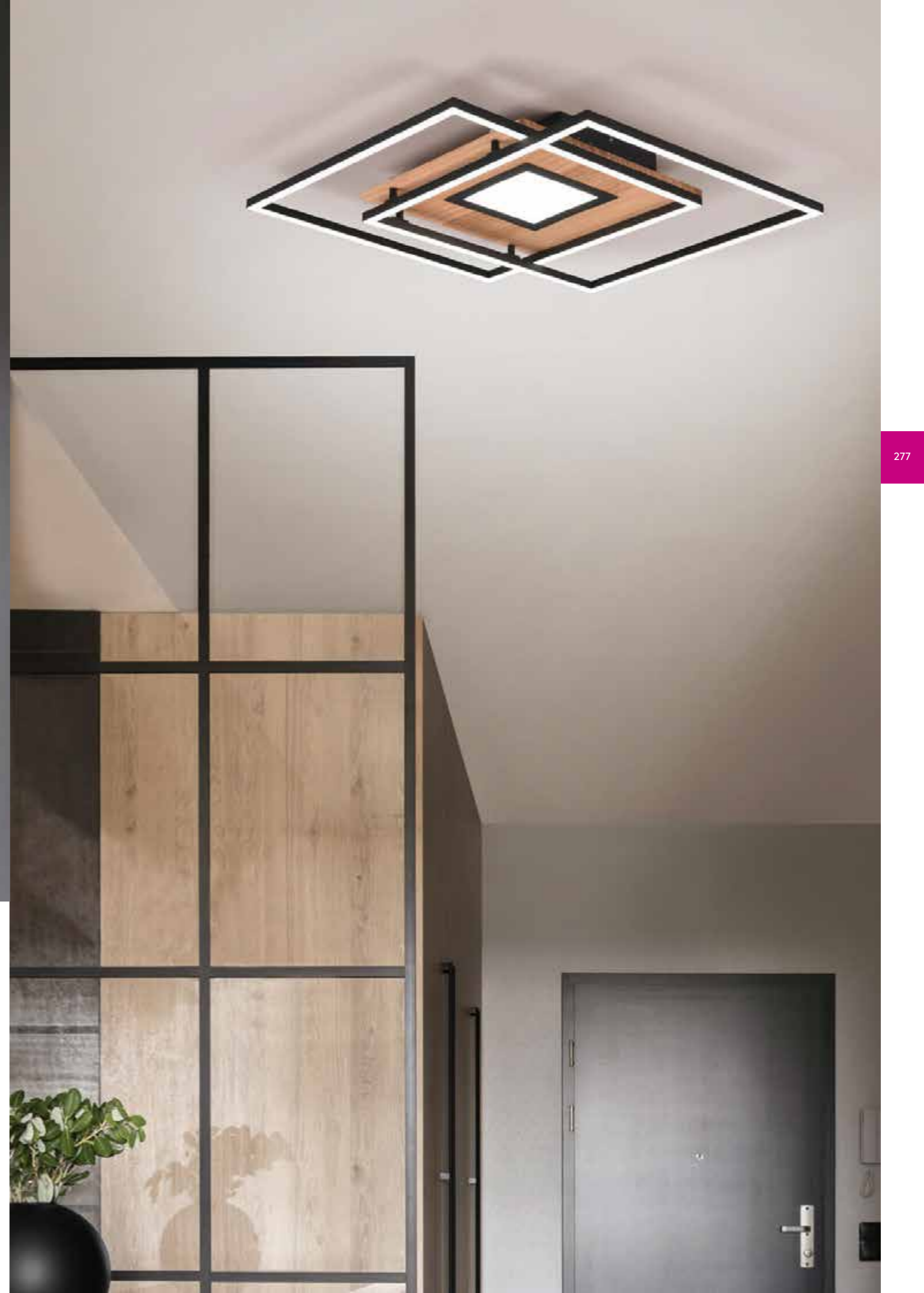
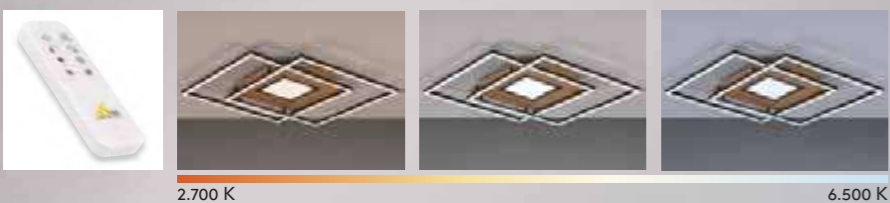



VIA

Metall · metal ·
metale · metaal · metal · metallo · metal · metalli · metal

 Lichtfarbe stufenlos einstellbar ·
Light color infinitely variable

 Integrierter Dimmer ·
Integrated dimmer

 **30** | holzfarbig · wood coloured

 **32** | Schwarz matt · black mat

 **31** | Weiß matt · white mat

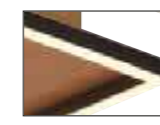
 **80** | Schwarz-Gold · black-gold

Deckenleuchte · Ceiling lamp
↔ 50 x 50 cm, ↓ 7,5 cm
incl. SMD-LED, 36 W
4.200 lm, 2.700 - 6.500 K



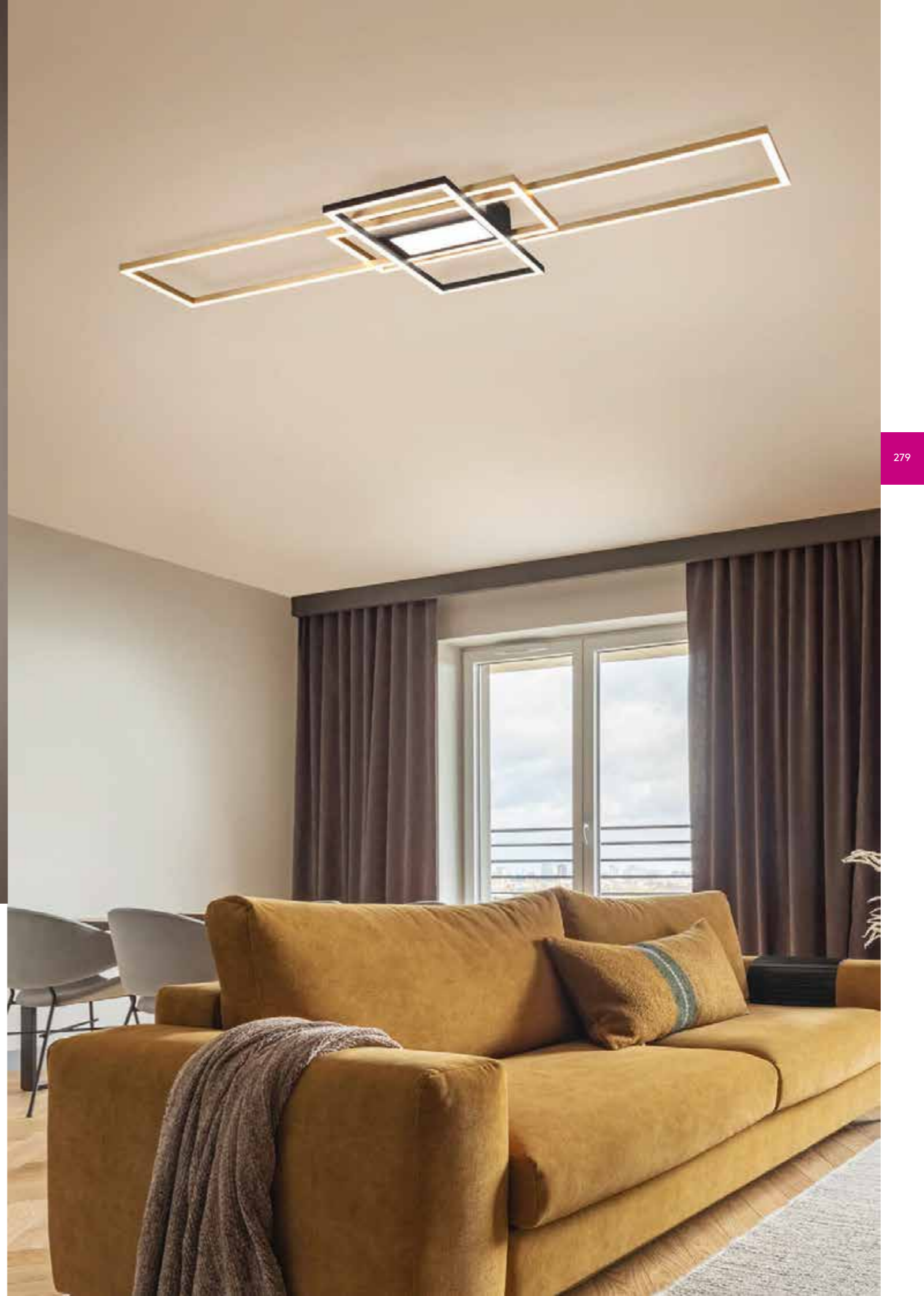
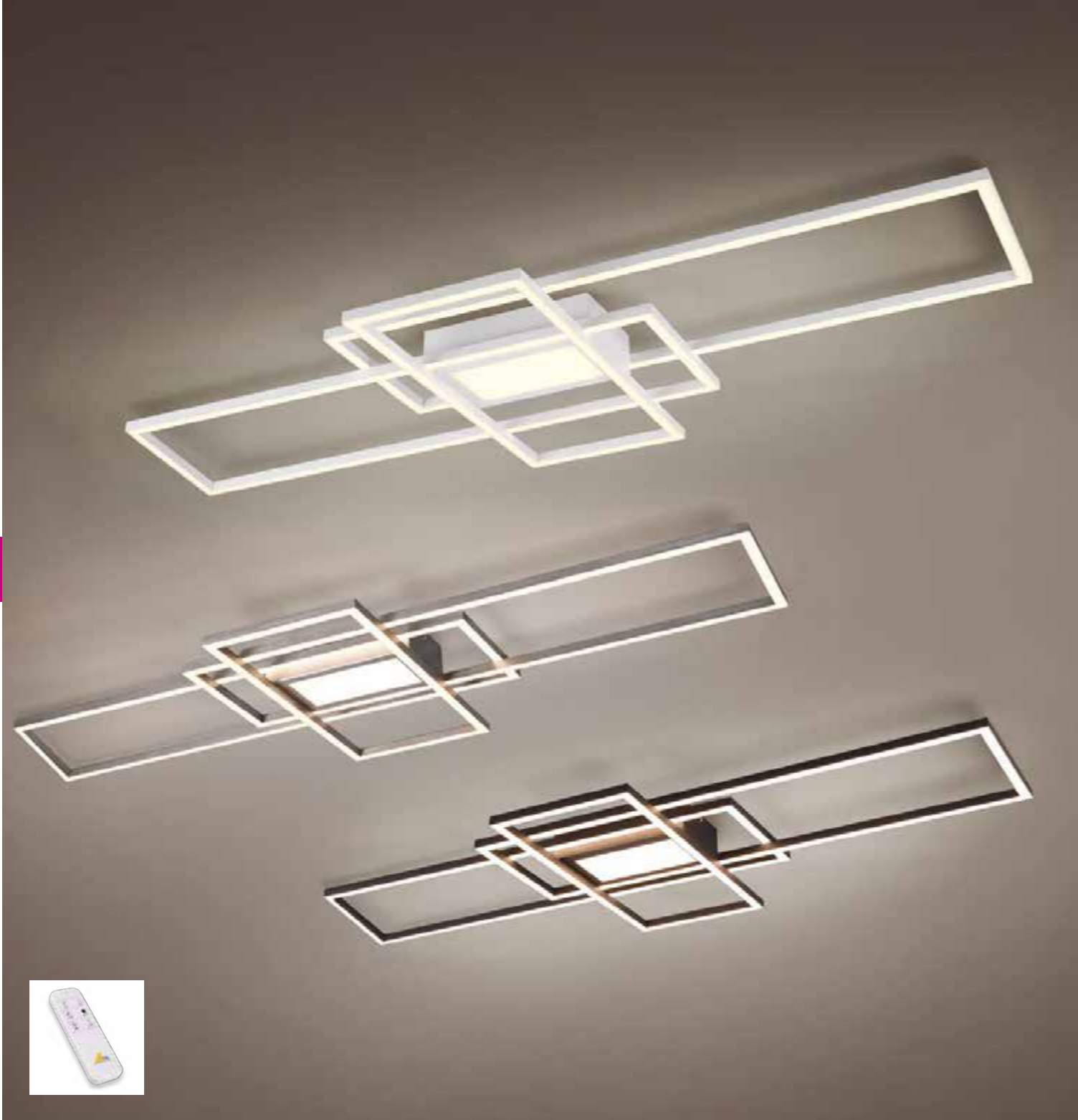

620710330
620710331
620710332
620710380



IRVINE

Metall · metal ·
metale · metaal · metal · metallo · metal · metalli · metal

 Lichtfarbe stufenlos einstellbar ·
Light color infinitely variable

 Integrierter Dimmer ·
Integrated dimmer

 Memory Funktion ·
Memory function



07 | Nickel matt · nickel mat

08 | Messing matt · brass mat



31 | Weiß matt · white mat

42 | Anthrazit · anthracite

Deckenleuchte · Ceiling lamp
↔ 105 x 42 cm, ↑ 6,5 cm
incl. SMD-LED, 60 W
7.100 lm, 3.000 - 6.500 K



620010407
620010408
620010431
620010442



SEDONA

Metall, Holznachbildung · metal, wood imitation ·
metale, imitacion bois · metaal, houtimitatie ·
metal, imitacion de madera · metallo, effetto legno ·
metal, imitatie de lemn · metalli, puujäljitelmä ·
metal, imitacja drewna

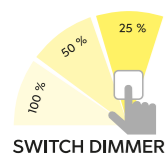

SWITCH DIMMER



Deckenleuchte · Ceiling lamp
Ø 80 cm, ↓ 8 cm
incl. SMD-LED, 40 W
4.800 lm, 3.000 K



673210306 | Chrom · chrome
673210332 | Schwarz matt, Holznachbildung ·
black mat, wood imitation



TUCSON

Metall, Schwarz matt / Holznachbildung · metal, black mat / wood imitation ·
Métal, Noir mat / imitation bois · Metaal, Mat zwart / houtimitatie · Metal, Estera negra / imitacion de madera ·
Metallo, Nero opaco / effetto legno · Metal, Negru mat / imitatie de lemn · Metall, mattamusta / puujäljitelmä ·
Metal, Czarny mat / imitacja drewna

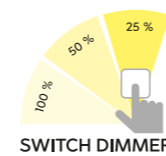

SWITCH DIMMER

Deckenleuchte · Ceiling lamp
↔ 104 x 42 cm, ↓ 8,5 cm
incl. SMD-LED, 35 W
4.400 lm, 3.000 K



672610332

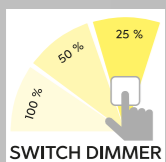

SORRENTO

Metall, schwarz matt · metal, black mat ·
 metale, noir mat · metaal, mat zwart · metal, estera negra ·
 metallo, nero opaco · metal, negru mat · metalli, mattamusta · metal, czarny mat



Deckenleuchte · Ceiling lamp
 ↔ 52,5 x 52,5 cm, ↑ 16 cm
 incl. SMD-LED, 24 W
 2.800 lm, 3.000 K



627710432



Deckenleuchte · Ceiling lamp
 ↔ 120,5 x 48,5 cm, ↑ 6 cm
 incl. SMD-LED, 34 W
 4.500 lm, 3.000 K



627710532



CHARLESTON

Metall, Aluminium gebürstet oder Anthrazit · metal, brushed aluminium or anthracite ·
 metale, aluminium balayé ou antracite · metaal, geborsteld aluminium of antraciet ·
 metal, aluminio pulido o antracita · metallo, alluminio spazzolato o antracite ·
 metal, aluminiu lucios sau antracit · metalli, harjattu alumiini tai antrasiitti ·
 metal, aluminium szczotkowane lub antracyt



Getrennt schaltbar ·
 Separately switchable



Memory Funktion ·
 Memory function

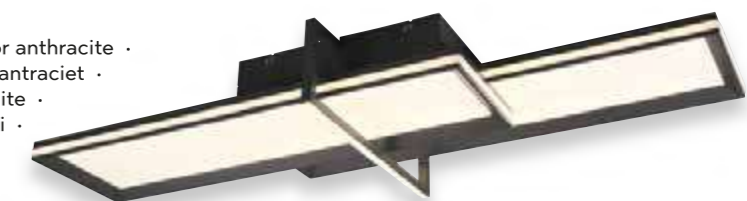

1x



2x



3x



Deckenleuchte · Ceiling lamp
 ↔ 101 x 38 cm, ↑ 12,5 cm
 incl. SMD-LED, 22 W
 2.600 lm, 3.000 K
 incl. SMD-LED, 13,5 W
 1.800 lm, 3.000 K



672110505 | Aluminium gebürstet · brushed aluminium
 672110542 | Anthrazit · anthracite

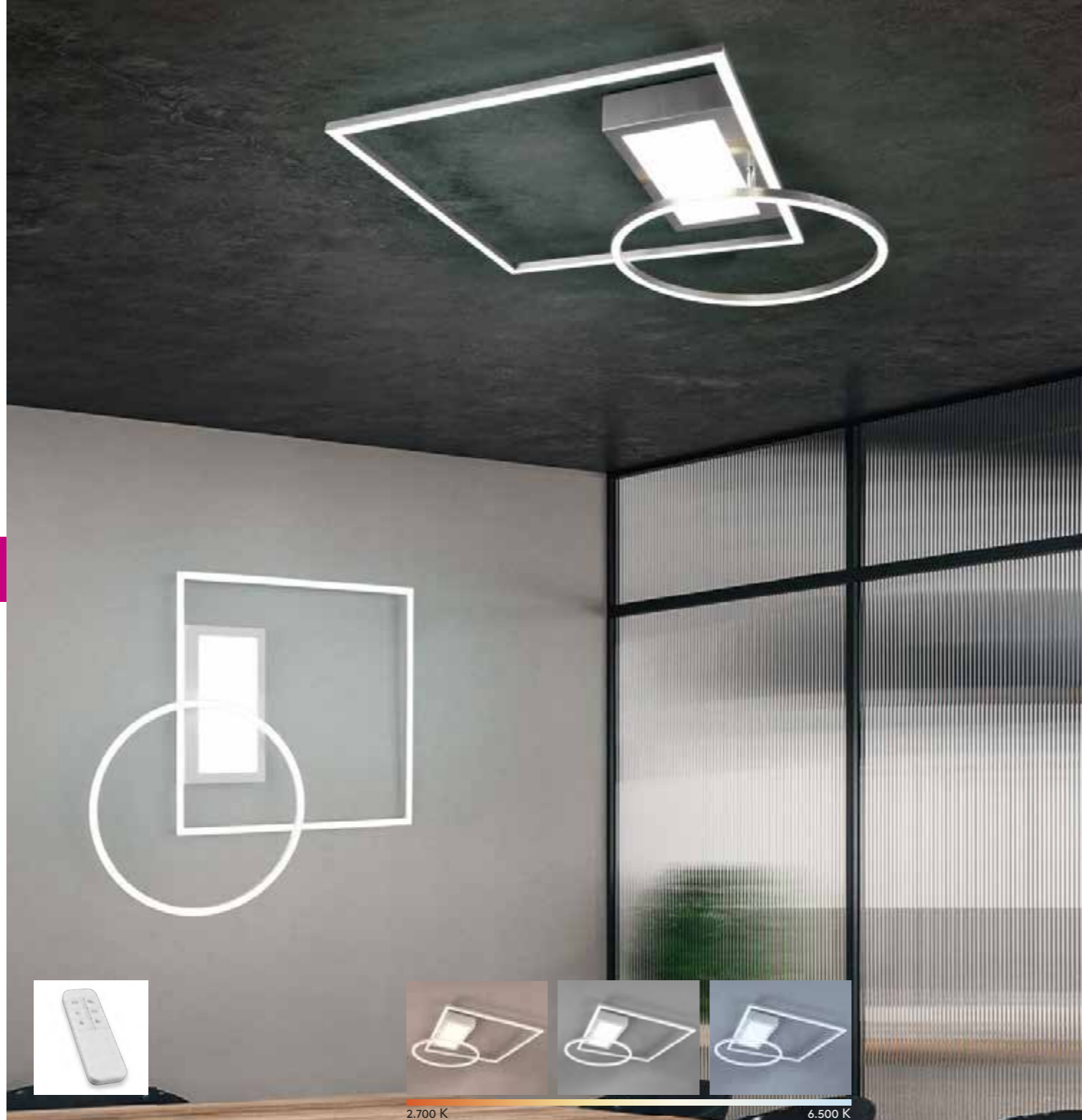

2.700 K 6.500 K

DOWNEY

Metall, Acryl · metal, acryl ·
 metale, acryl · metaal, acryl · metal, acrílico ·
 metallo, acrilico · metal, acrilic · metalli, akryyli · metal, akryl

Lichtfarbe stufenlos einstellbar ·
 Light color infinitely variable

Integrierter Dimmer ·
 Integrated dimmer

Memory Funktion ·
 Memory function



Schwenkbar · tiltable

Deckenleuchte · Ceiling lamp
 ↔ 64,5 x 86,5 cm, ↓ 89 cm
 incl. SMD-LED, 33 W
 4.600 lm, 2.700 - 6.500 K



620510307 | Nickel matt · nickel mat
 620510331 | Weiß matt · white mat
 620510332 | Schwarz matt · black mat



YAVA

Metall, Acryl · metal, acryl ·
 metale, acryl · metaal, acryl · metal, acrílico ·
 metallo, acrilico · metal, acrilic · metalli, akryyli · metal, akryl

Lichtfarbe stufenlos einstellbar ·
 Light color infinitely variable

Integrierter Dimmer ·
 Integrated dimmer



Deckenleuchte · Ceiling lamp
 Ø 60 cm, ↓ 7 cm
 incl. SMD-LED, 56 W
 6.800 lm, 2.700 - 6.000 K



672310207
 672310232



07 | Nickel matt · nickel mat



32 | Schwarz matt · black mat



GALE

Metall, Nickel matt, Weiß matt oder Schwarz matt · metal, nickel mat, white mat or black mat ·
 metale, nickel mat, blanc mat ou noir mat · metaal, nikkel mat, wit mat of mat zwart ·
 metal, níquel mate, estera blanca o estera negra · metallo, nichel opaco, bianco opaco o nero opaco ·
 metal, nichel mat, alb mat sau negru mat · metalli, harjattu teräs, mattavalkoinen tai mattamusta ·
 metal, nikiel mat, biały mat lub czarny mat

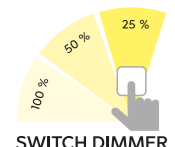

SWITCH DIMMER



07 | Nickel matt · nickel mat



31 | Weiß matt · white mat



32 | Schwarz matt · black mat



Deckenleuchte · Ceiling lamp
 ↔ 60 x 43 cm, ↑ 13,5 cm
 incl. SMD-LED, 38,5 W
 5.000 lm, 3.000 K



673916007
 673916031
 673916032



Deckenleuchte · Ceiling lamp
 ↔ 80 x 65 cm, ↑ 14,5 cm
 incl. SMD-LED, 50 W
 7.000 lm, 3.000 K



673918007
 673918031
 673918032

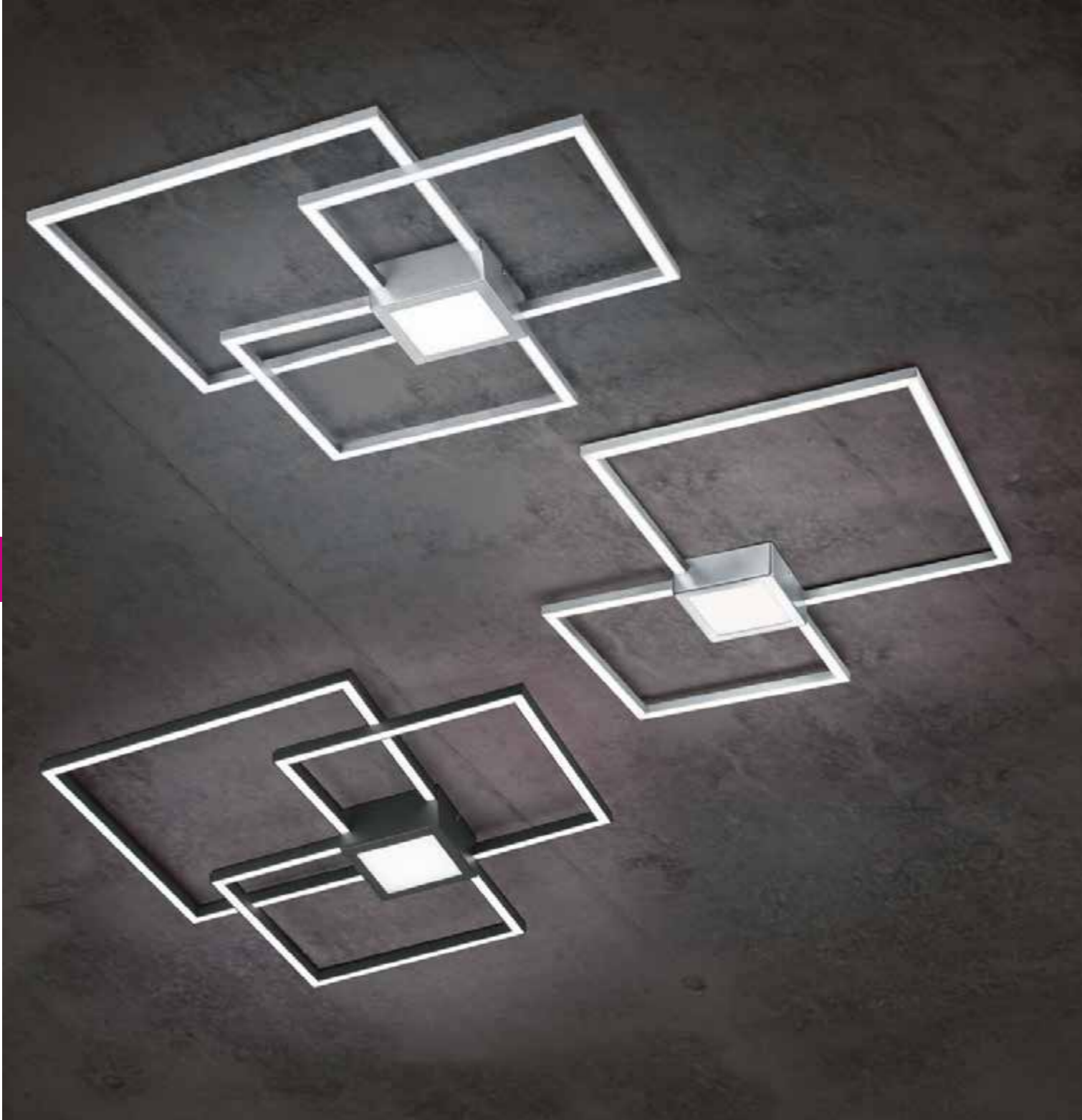

07 | Nickel matt · nickel mat



42 | Anthrazit · anthracite



Deckenleuchte · Ceiling lamp
↔ 65 x 65 cm, ↑ 5 cm
incl. SMD-LED, 28 W
2.600 lm, 3.000 K



676210307
676210342

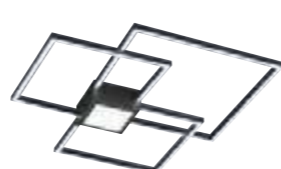

Deckenleuchte · Ceiling lamp
↔ 65,5 x 66,5 cm, ↑ 6,5 cm
incl. SMD-LED, 28 W
4.400 lm, 3.000 K



676210407
676210442

HYDRA

Chrom, Nickel matt, Weiß matt oder Anthrazit · chrome, nickel mat, white mat or anthracite · chrome, nickel mat, blanc mat ou anthracite · chroom, nikkell mat, wit mat of antraciet · cromo, níquel mate, estera blanca o antracita · cromo, nichel opaco, bianco opaco o antracite · crom, nichel mat, alb mat sau antracit · kromi, harjattu teräs, mattavalkoinen tai antrasiitti · chrom, nikiel mat, biały mat lub antracyt

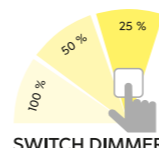

SWITCH DIMMER



31 | Weiß matt · white mat

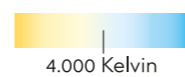

Deckenleuchte · Ceiling lamp
↔ 65 x 65 cm, ↑ 5 cm
incl. SMD-LED, 28 W
3.200 lm, 4.000 K



676240331

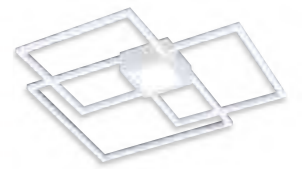

Deckenleuchte · Ceiling lamp
↔ 65,5 x 65 cm, ↑ 6,5 cm
incl. SMD-LED, 38 W
4.400 lm, 4.000 K



676240431



GANADO

Metall, Nickel matt oder Schwarz matt · metal, nickel mat or black mat ·
metale, nikel mat ou noir mat · metaal, nikkell mat of mat zwart · metal, níquel mate o estera negra ·
metallo, nichel opaco o nero opaco · metal, nichel mat sau negru mat · metalli, harjattu teräs tai mattamusta ·
metal, nikiel mat lub czarny mat



RGBW Farbwechsler ·
RGBW Colorchanging



Lichtfarbe stufenlos einstellbar ·
Light color infinitely variable



Getrennt schaltbar ·
Separately switchable



indirekte Beleuchtung ·
indirect lighting

Deckenleuchte · Ceiling lamp

↔ 110 x 21,2 cm, ↑ 7 cm
incl. SMD-LED, 37 W
4.300 lm, 2.700 - 6.500 K
incl. RGB-LED, 8 W



670710507 | Nickel matt · nickel mat
670710532 | Schwarz matt · black mat



WINONA

Metall, Nickel matt oder Schwarz matt · metal, nickel mat or black mat ·
metale, nikel mat ou noir mat · metaal, nikkell mat of mat zwart · metal, níquel mate o estera negra · metallo, nichel opaco o nero opaco ·
metal, nichel mat sau negru mat · metalli, harjattu teräs tai mattamusta ·
metal, nikiel mat lub czarny mat



RGBW Farbwechsler ·
RGBW Colorchanging



Lichtfarbe stufenlos einstellbar ·
Light color infinitely variable



Getrennt schaltbar ·
Separately switchable



indirekte Beleuchtung ·
indirect lighting



Deckenleuchte · Ceiling lamp

↔ 78 x 62 cm, ↑ 11,5 cm
incl. SMD-LED, 28 W
3.200 lm, 2.700 - 6.500 K
incl. RGB-LED, 10 W



670810607 | Nickel matt · nickel mat
670810632 | Schwarz matt · black mat



CRYSTEL

Chrom, Glas chrom bedampft, Acryl · chrome, chrome plated glass, acryl ·
 Chrome, Verre plaqué chrome, Acryl · Chroom, Chroom opgedampt glas, Acryl · Cromo, Vidrio cromado, Acrílico ·
 Cromo, Vetro verniciato cromo, Acrilico · Crom, Sticla cromata, Acrilic · Kromi, Kromipäällystetty lasi, Akryyli ·
 Chrom, Szkło chromowane, Akryl

Empfohlen:
 recommended: Filament LED E14, 4 W
 470 lm, 2.700 K



983-400



Deckenleuchte · Ceiling lamp
 Ø 34 cm, ↑ 17,5 cm
 excl. 3 x E14, max. 28 W



616700306



Deckenleuchte · Ceiling lamp
 Ø 50 cm, ↑ 23,5 cm
 excl. 5 x E14, max. 28 W



616700506

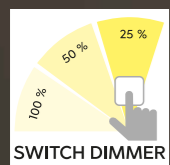
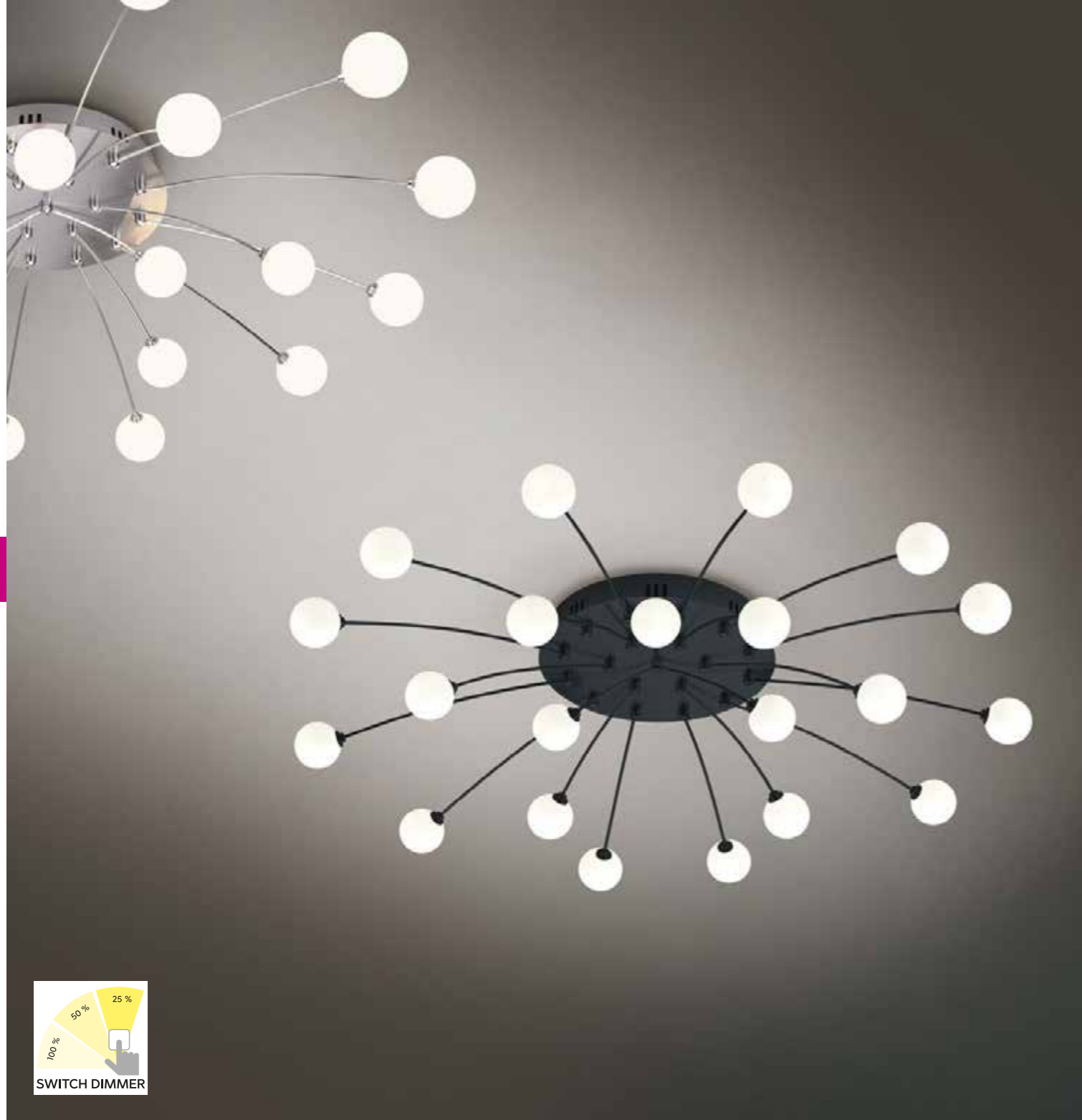

BULLET

Metall, Glas · metal, glass ·
 metale, verre · metaal, glas · metal, vidrio ·
 metallo, vetro · metal, sticla · metalli, lasi · metal, szkło



06 | Chrom, Glas chrom bedampft ·
 chrome, chrome plated glass



07 | Nickel matt, Glas weiß matt ·
 nickel mat, white mat glass



32 | Schwarz matt, Glas weiß matt ·
 black mat, white mat glass

Deckenleuchte · Ceiling lamp
 Ø 96 cm, ↑ 15,8 cm
 incl. 21 x SMD-LED, 1,5 W
 21 x 170 lm, 3.000 K



641412106
 641412107
 641412132

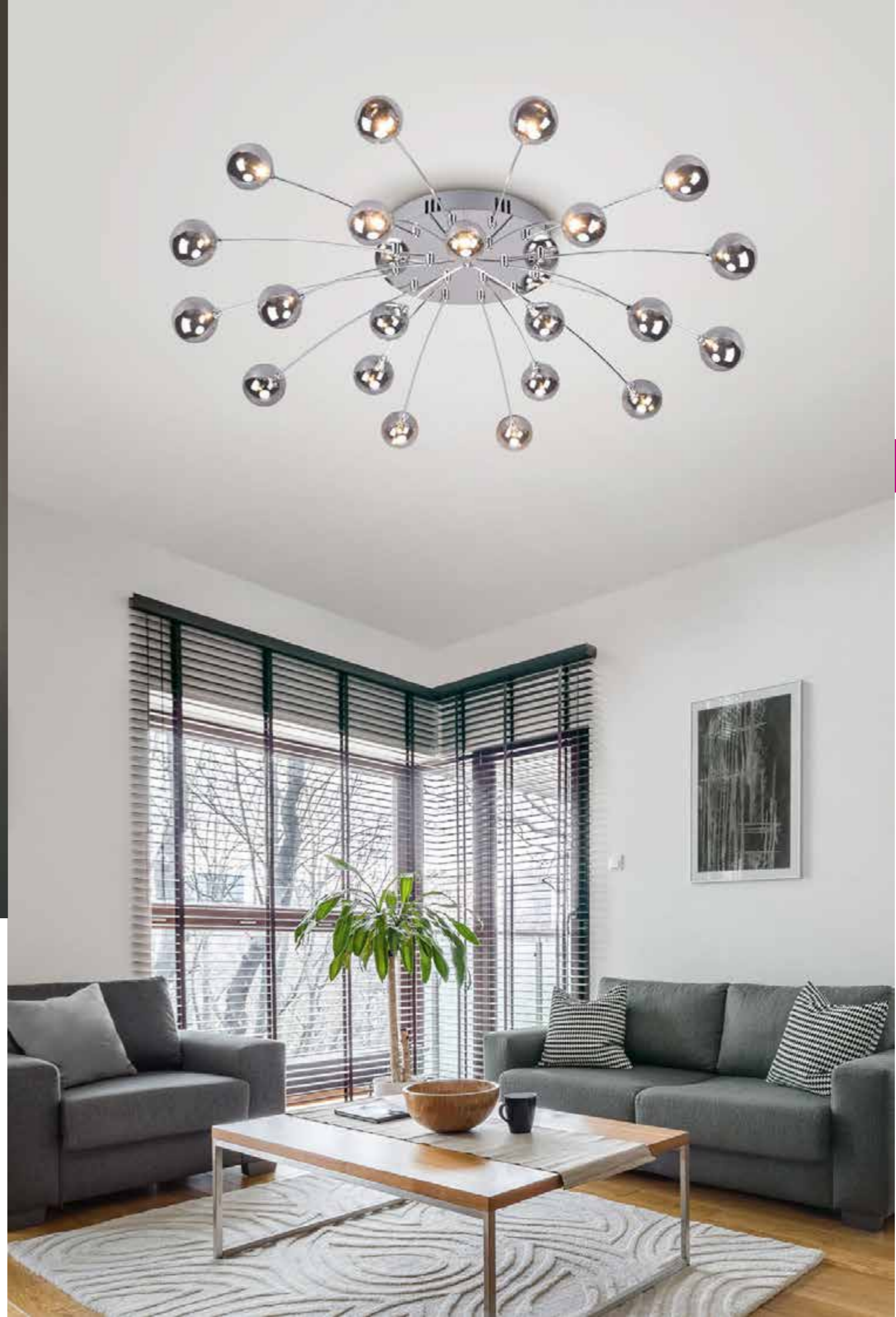



PEACOCK

Metall, schwarz matt · metal, black mat ·
metale, noir mat · metaal, mat zwart · metal, estera negra · metallo, nero opaco ·
metal, negru mat · metalli, mattamusta · metal, czarny mat

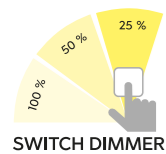

SWITCH DIMMER



Deckenleuchte · Ceiling lamp
↔ 115 x 97,5 cm, ↓ 10,5 cm
incl. 15 x SMD-LED, 2,6 W
15 x 270 lm, 3.000 K



679511532



BODRUM

Chrom · chrome ·
chrome · chroom · cromo · cromo · crom · kromi · chrom · krom

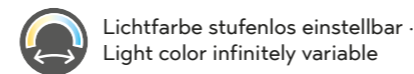

Lichtfarbe stufenlos einstellbar ·
Light color infinitely variable

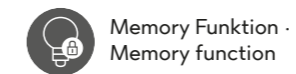

Memory Funktion ·
Memory function



3.000 K

6.500 K

Deckenleuchte · Ceiling lamp
Ø 100 cm, ↓ 8,5 cm
incl. 12 x SMD-LED, 2,2 W
12 x 250 lm, 3.000 - 6.500 K
incl. 1 x SMD-LED, 5 W
550 lm, 3.000 - 6.500 K



673311306

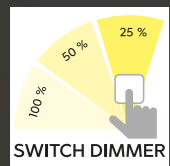
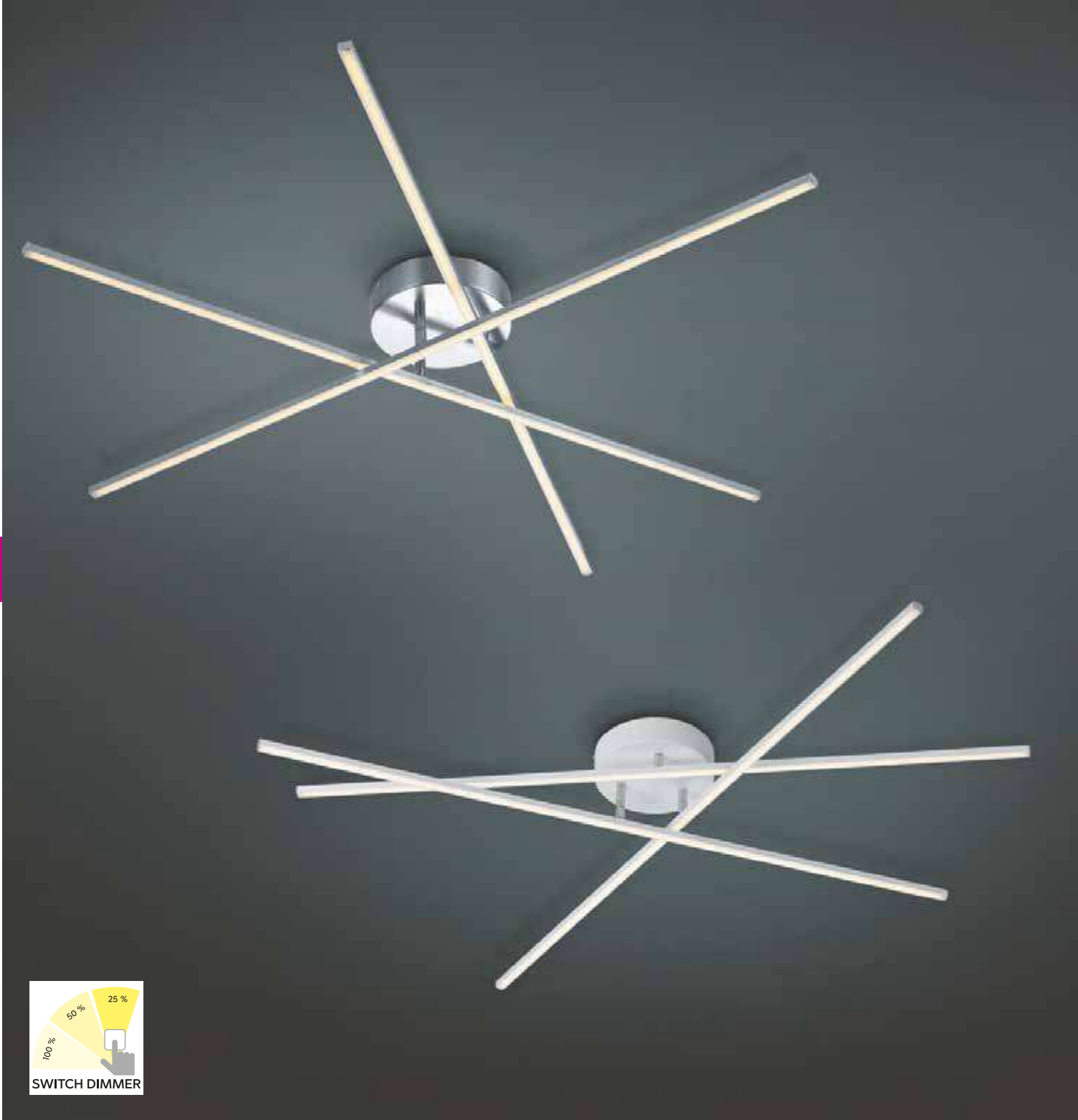

TIRIAC

Metall · metal ·
 metale · metaal · metal · metallo · metal · metalli · metal



07 | Nickel matt · nickel mat

31 | Weiß matt · white mat

Deckenleuchte · Ceiling lamp
 ↔ 100 cm, ↓ 12 cm
 incl. 3 x SMD, 9 W
 3 x 950 lm, 3.000 K



671610307
 671610331



OXFORD

Metall, weiß matt · metal, white mat ·
 metale, blanc mat · metaal, wit mat · metal, estera blanca · metallo, bianco opaco ·
 metal, alb mat · metalli, mattavalkoinen · metal, biały mat

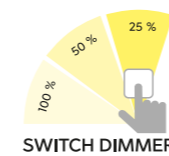

Deckenleuchte · Ceiling lamp
 ↔ 102 x 78 cm, ↓ 5 cm
 incl. SMD-LED, 27 W
 3.600 lm, 4.000 K



674410331

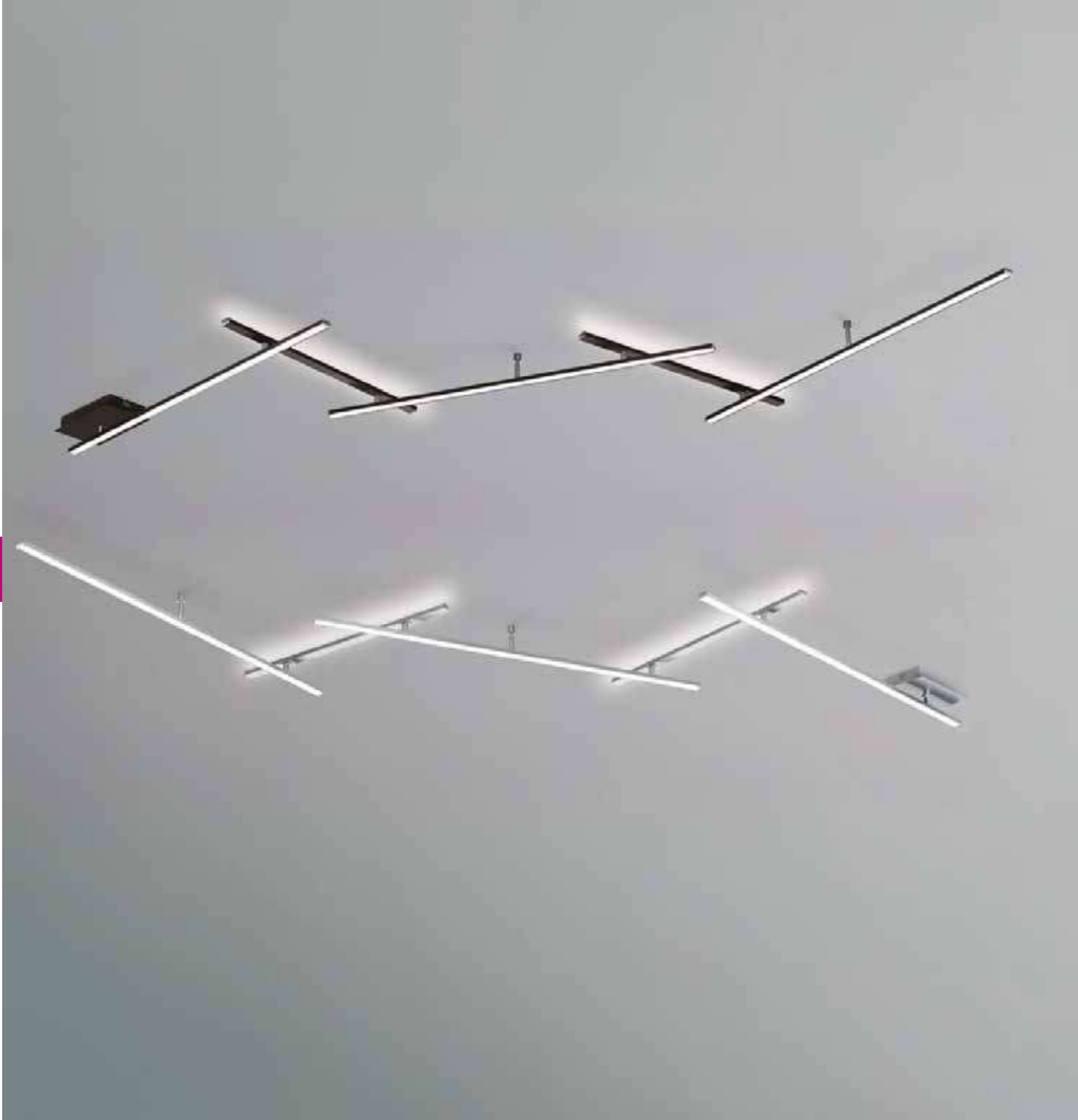

Deckenleuchte · Ceiling lamp
 ↔ max. 245 cm, ↓ 6,5 cm
 incl. SMD-LED, 25 W
 3.000 lm, 3.000 K



674610507 | Nickel matt · nickel mat
 674610532 | Schwarz matt · black mat



INDIRA

Metall, Nickel matt oder Schwarz matt, Acryl · metal, nickel mat or black mat, acryl ·
 metale, nickel mat ou noir mat, acryl · metaal, nikkel mat of mat zwart, acryl · metal, níquel mate o estera negra, acrílico ·
 metallo, nichel opaco o nero opaco, acrilico · metal, nichel mat sau negru mat, acrilic ·
 metalli, harjattu teräs tai mattamusta, akryyli · metal, nikiel mat lub czarny mat, akryl

Gibt Licht nach oben und unten · up and down lighting ·
 point lumineux en haut et en bas · lichtpunt boven en onder ·
 luz de arriba y abajo · luce su e giù · sus și în jos lumina ·
 ylös ja alas valoa · w górę iw dół światło

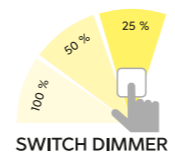

SWITCH DIMMER



Deckenleuchte · Ceiling lamp
 ↔ max. 345 cm, ↓ 6,5 cm
 incl. SMD-LED, 28 W
 3.500 lm, 3.000 K



674610707

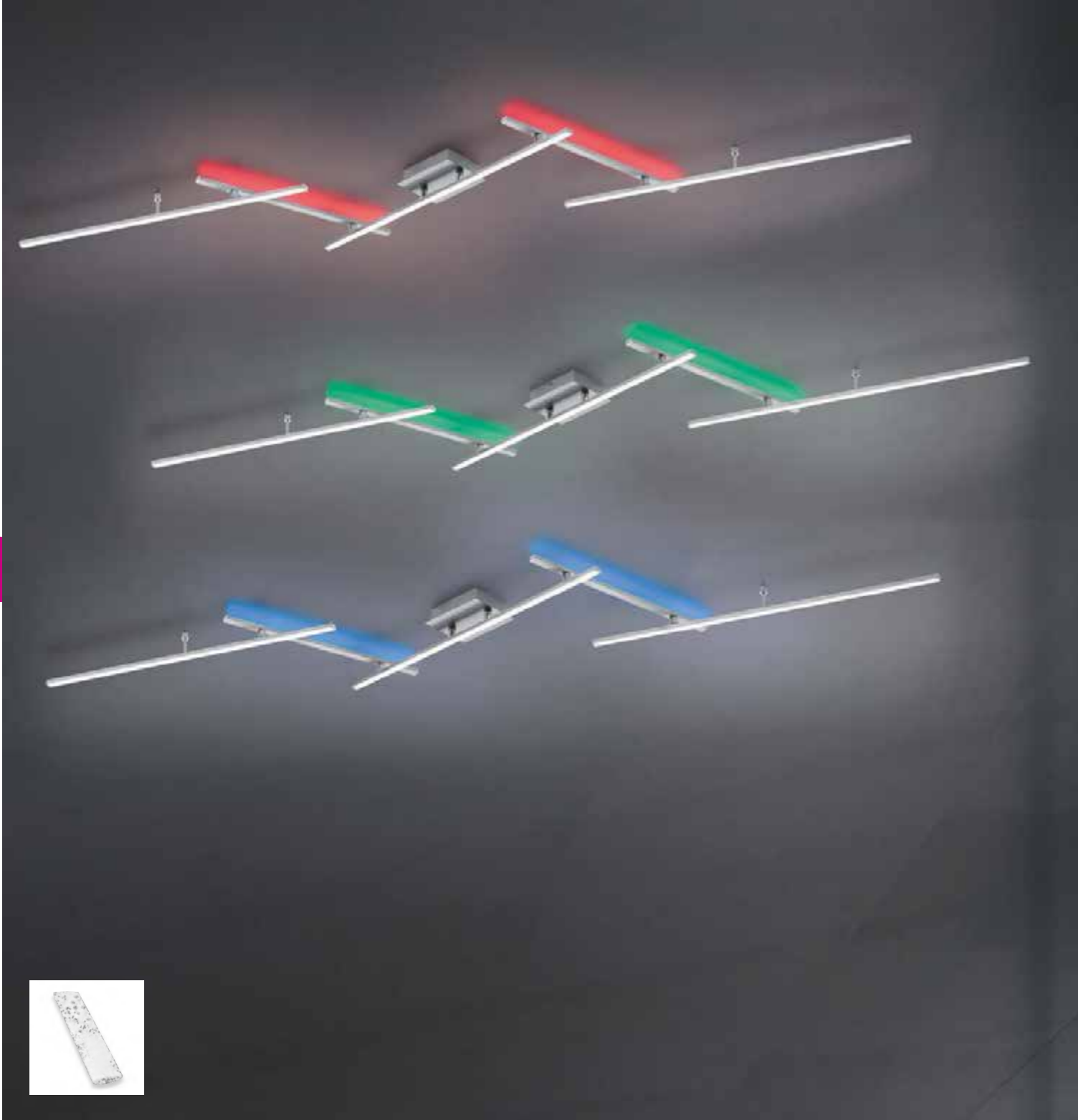

Gibt Licht nach oben und unten, getrennt schaltbar · up and down lighting, separately switchable ·
 point lumineux en haut et en bas, interrupteurs séparés · lichtpunt boven en onder, gescheiden schakelbaar ·
 luz de arriba y abajo, interruptores separados · luce su e giù, interruttori separati · sus și în jos lumina, intreruptoare separate ·
 ylös ja alas valoa, erikseen kytkettävissä · w górę iw dół światło, oddzielny przełącznik



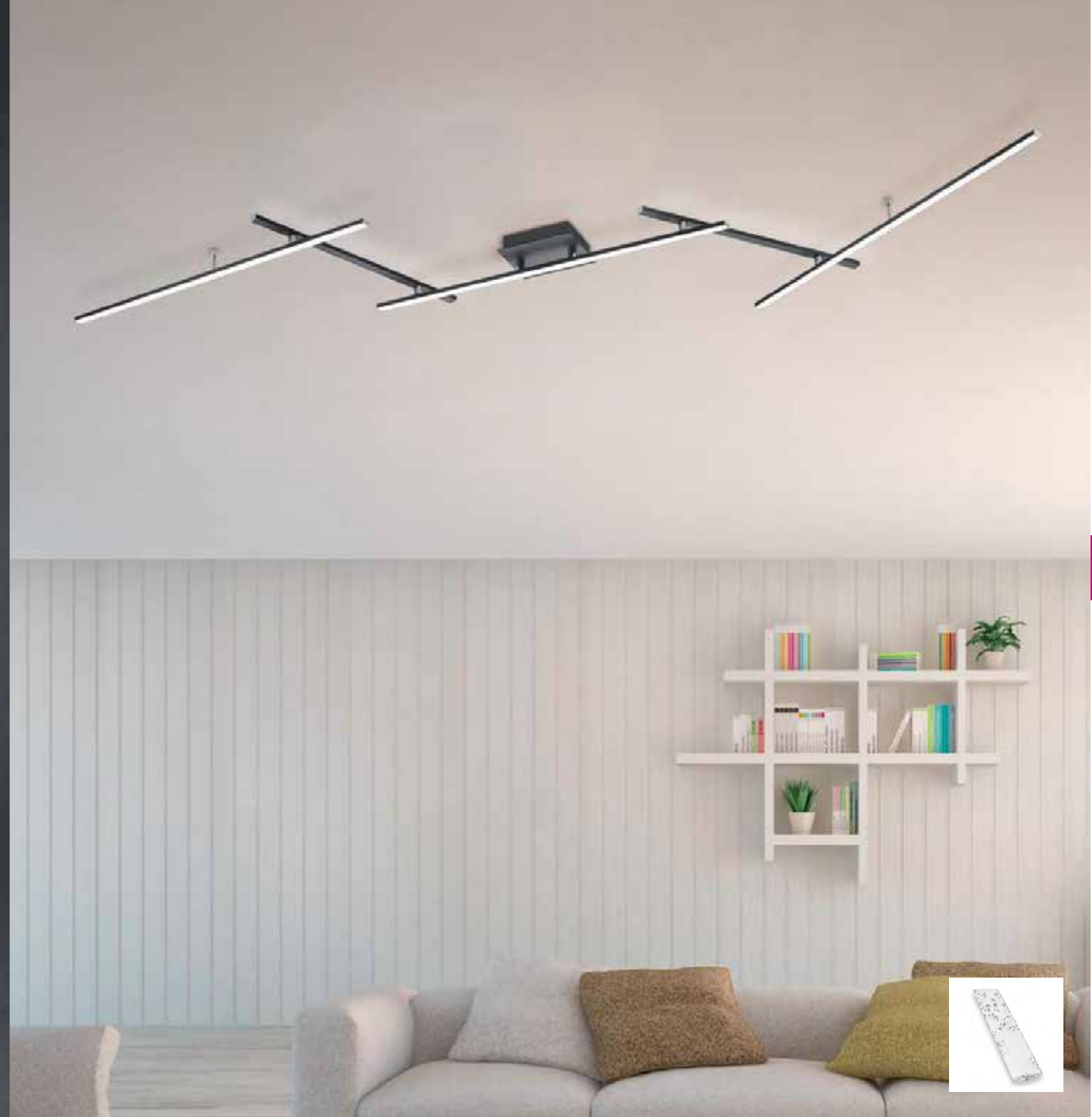

2.700 K 6.500 K





ARVIN

Metall, Nickel matt oder Schwarz matt · metal, nickel mat or black mat ·
 metale, nickel mat ou noir mat · metaal, nikkel mat of mat zwart · metal, níquel mate o estera negra ·
 metallo, nichel opaco o nero opaco · metal, nichel mat sau negru mat · metalli, harjattu teräs tai mattamusta ·
 metal, nikiel mat lub czarny mat

 RGBW Farbwechsler ·
 RGBW Colorchanging

 Lichtfarbe stufenlos einstellbar ·
 Light color infinitely variable

 Getrennt schaltbar ·
 Separately switchable

-  **07** | Nickel matt · nickel mat
-  **32** | Schwarz matt · black mat

Deckenleuchte · Ceiling lamp
 ↔ max. 245 x 50 cm, ↑ 8,5 cm
 incl. SMD-LED, 22 W
 2.600 lm, 2.700 - 6.500 K
 incl. RGB-LED, 8 W



628410507
 628410532



KAGAWA

Metall Weiß matt, Acryl · metal white mat, acryl ·
metale blanc mat, acryl · metaal wit mat, acryl ·
metal estera blanca, acrílico · metallo bianco opaco, acrilico ·
metal alb mat, acrilic · metalli valkoinen matto, akryyli · metal biały mat, akryl

 Lichtfarbe stufenlos einstellbar ·
Light color infinitely variable

 Memory Funktion ·
Memory function

 Nachtlcht ·
Night light



Deckenleuchte · Ceiling lamp
Ø 50 cm, ↓ 6 cm
incl. SMD-LED, 40 W
5.000 lm, 2.700 - 6.000 K





625815031



AKITA

Metall Weiß matt, Acryl · metal white mat, acryl ·
metale blanc mat, acryl · metaal wit mat, acryl ·
metal estera blanca, acrílico · metallo bianco opaco, acrilico ·
metal alb mat, acrilic · metalli valkoinen matto, akryyli · metal biały mat, akryl

 Lichtfarbe stufenlos einstellbar ·
Light color infinitely variable

 Memory Funktion ·
Memory function



Deckenleuchte · Ceiling lamp
↔ 48 x 48 cm, ↓ 5,5 cm
incl. SMD-LED, 56 W
6.550 lm, 3.000 - 6.500 K



647110131



MITA

Metall Weiß matt, Acryl · metal white mat, acryl ·
 metale blanc mat, acryl · metaal wit mat, acryl ·
 metal estera blanca, acrílico · metallo bianco opaco, acrilico ·
 metal alb mat, acrilic · metalli valkoinen matto, akryyli · metal biały mat, akryl



Lichtfarbe stufenlos einstellbar ·
 Light color infinitely variable



Integrierter Dimmer ·
 Integrated dimmer



Deckenleuchte · Ceiling lamp
 Ø 51 cm, ↑ 7 cm
 incl. SMD-LED, 74 W
 9.000 lm, 2.700 - 6.000 K



629210331



Deckenleuchte · Ceiling lamp
 ↔ 51,5 x 51,5 cm, ↑ 7 cm
 incl. SMD-LED, 76 W
 9.250 lm, 2.700 - 6.000 K



629219331



2.700 K

6.000 K



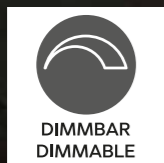
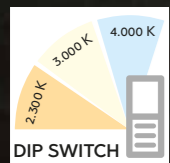
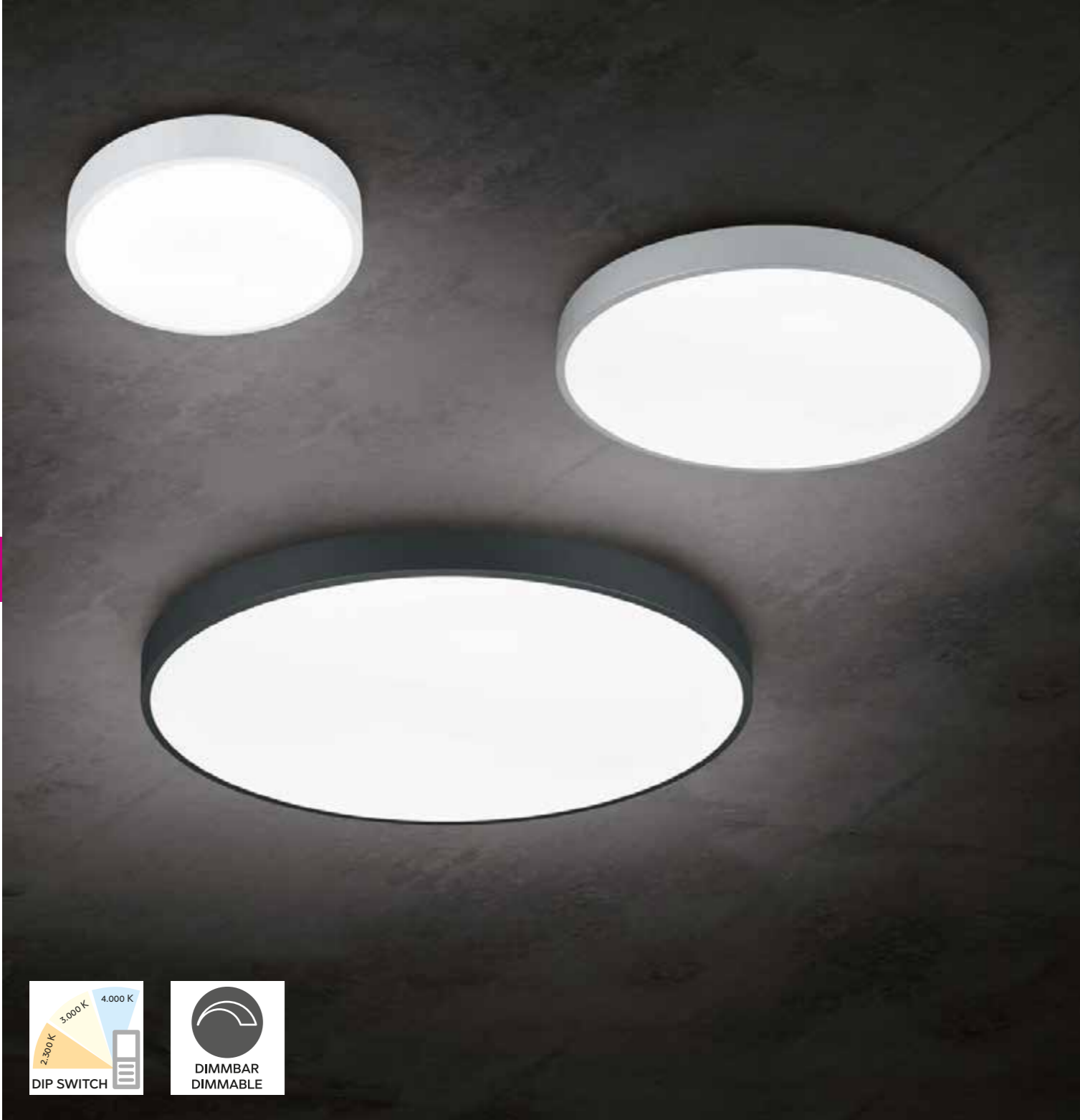

Lichtfarben direkt an der Leuchte einstellbar ·
 Colours directly adjustable at the lamp ·
 Les couleurs de la lumière peuvent être réglées directement sur le luminaire ·
 Lichtkleuren direct instelbaar op de lamp ·
 Tonalidades de luz ajustables directamente en la lámpara ·
 Colori della luce regolabili direttamente sulla lampada ·
 Culori ale luminii reglabile direct de la bec ·
 Valon väri asetettävissa suoraan valaisimesta ·
 Barwy światła można ustawić bezpośrednio na oprawie



WACO

Metall, Acryl · metal, acryl ·
 metale, acryl · metaal, acryl · metal, acrílico ·
 metallo, acrilico · metal, acrilic · metalli, akryyli · metal, akryl

| | | | |
|---|--|--|--|
|  31 Weiß matt · white mat  32 Schwarz matt · black mat  87 titanfarbig · titan |  Deckenleuchte · Ceiling lamp Ø 31 cm, ↓ 6,5 cm incl. SMD-LED, 28 W 3.200 lm, 2.300 + 3.000 + 4.000 K   627413031 627413032 627413087 |  Deckenleuchte · Ceiling lamp Ø 49,5 cm, ↓ 6,5 cm incl. SMD-LED, 52,5 W 6.200 lm, 2.300 + 3.000 + 4.000 K   627415031 627415032 627415087 |  Deckenleuchte · Ceiling lamp Ø 75 cm, ↓ 7 cm incl. SMD-LED, 100 W 12.400 lm, 2.300 + 3.000 + 4.000 K   627417531 627417532 627417587 |
|---|--|--|--|



Getrennt schaltbar · Separately switchable

Lichtfarbe einstellbar · Adjustable light color



1x

2x

3x



2.300 K



3.000 K



4.000 K

DOHA

Metall, Acryl · metal, acryl ·
metale, acryl · metaal, acryl · metal, acrílico ·
metallo, acrilico · metal, acrilic · metalli, akryyli ·
metal, akryl

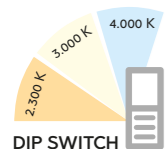

DIP SWITCH



08 | Messing matt · brass mat



31 | Weiß matt · white mat



32 | Schwarz matt · black mat



65 | Coffee · coffee

Deckenleuchte · Ceiling lamp
Ø 45 cm, ↑ 5,5 cm
incl. SMD-LED, 29 W
3.260 lm, 2.300 + 3.000 + 4.000 K



641310208
641310231
641310232
641310265





2.700 K

6.500 K

MORGAN

Metall, Acryl · metal, acryl ·
metale, acryl · metaal, acryl · metal, acrílico ·
metallo, acrílico · metal, acrílic · metalli, akryyli · metal, akryl



Lichtfarbe stufenlos einstellbar ·
Light color infinitely variable



Integrierter Dimmer ·
Integrated dimmer

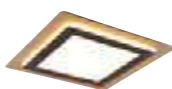

Deckenleuchte · Ceiling lamp
↔ 45 x 45 cm, ↑ 4,2 cm
incl. SMD-LED, 46 W
6.000 lm, 2.700 - 6.500 K



641510207
641510280



Deckenleuchte · Ceiling lamp
Ø 45 cm, ↑ 4,2 cm
incl. SMD-LED, 42 W
5.600 lm, 2.700 - 6.500 K



641519207
641519280

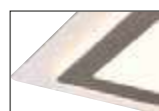

07 | Weiß matt / Nickel ·
white mat / nickel

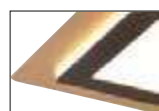

80 | Schwarz matt / goldfarbig ·
black mat / gold



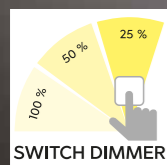

GIRONA

Metall, Acryl · metal, acryl ·
 metale, acryl · metaal, acryl · metal, acrílico ·
 metallo, acrilico · metal, acrilic · metalli, akryyli · metal, akryl

31 | Weiß matt · white mat
 4.000 Kelvin

32 | Schwarz matt · black mat



Deckenleuchte · Ceiling lamp
 Ø 45 cm, ↑ 11 cm
 incl. SMD-LED, 27 W
 3.200 lm, 3.000 K
 (31 = 3.200 lm, 4.000 K)



671210131
 671210132



2.700 K

6.500 K



Deckenleuchte · Ceiling lamp
 Ø 60 cm, ↑ 12 cm
 incl. SMD-LED, 48 W
 5.600 lm, 2.700 - 6.000 K



671290131
 671290132

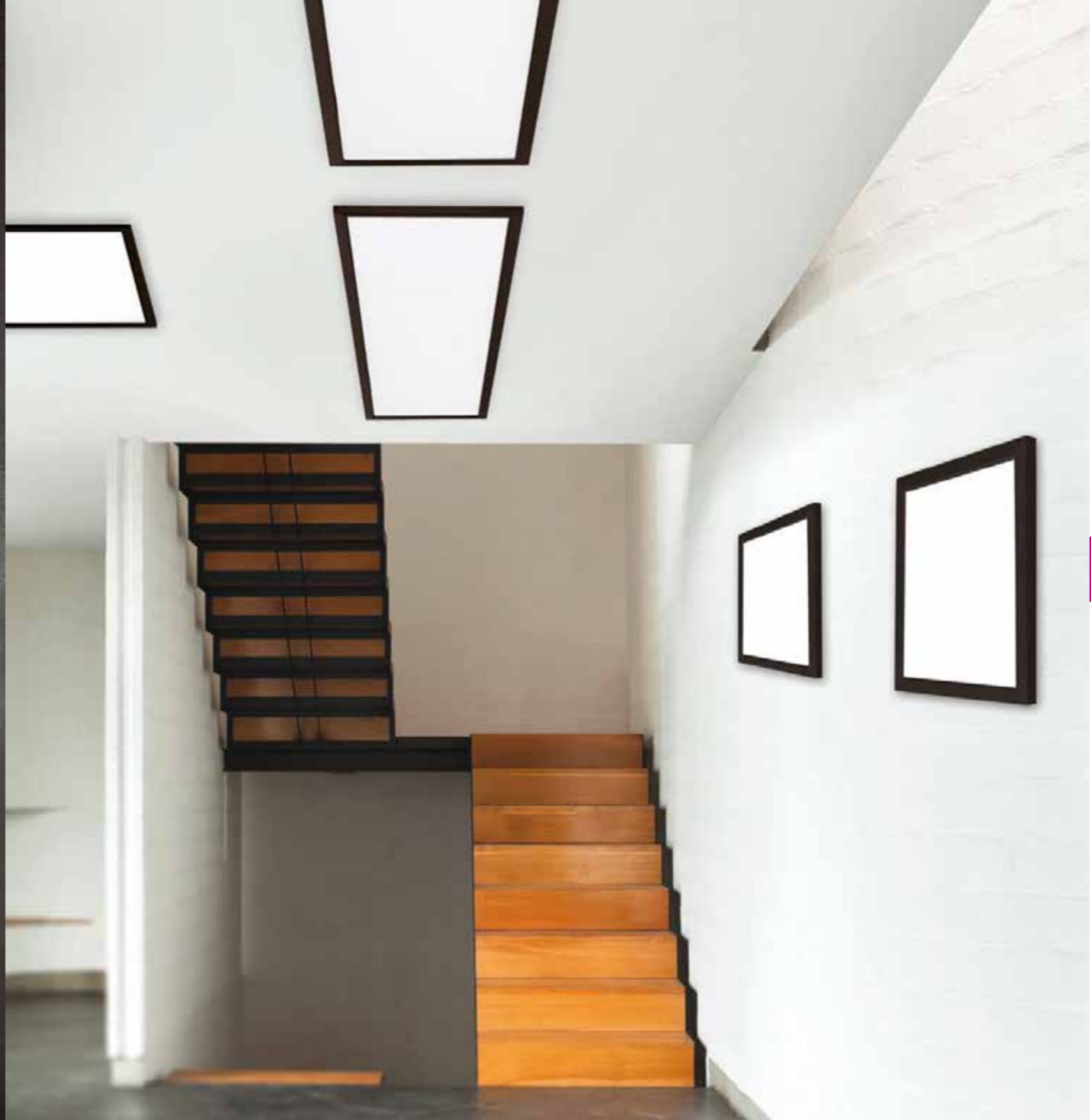

PHOENIX

Metall, Schwarz matt, Acryl · metal, black mat, acryl · métal, noir mat, acryl · metaal, mat zwart, acryl · metal, estera negra, acrílico · metallo, nero opaco, acrilico · metal, negru mat, acrilic · metalli, mattamusta, akryyli · metal, czarny mat, akryl



Deckenleuchte · Ceiling lamp
Ø 30 cm, ↑ 4,2 cm
incl. SMD-LED, 15 W
1.700 lm, 3.000 K



674093032



Deckenleuchte · Ceiling lamp
Ø 45 cm, ↑ 4,2 cm
incl. SMD-LED, 26 W
3.000 lm, 3.000 K



674094532



Deckenleuchte · Ceiling lamp
Ø 62 cm, ↑ 4,2 cm
incl. SMD-LED, 31 W
3.600 lm, 3.000 K



674096232



Deckenleuchte · Ceiling lamp
↔ 30 x 30 cm, ↑ 4,2 cm
incl. SMD-LED, 15 W
1.700 lm, 3.000 K



674013032



Deckenleuchte · Ceiling lamp
↔ 45 x 45 cm, ↑ 4,2 cm
incl. SMD-LED, 26 W
3.000 lm, 3.000 K



674014532



Deckenleuchte · Ceiling lamp
↔ 62 x 62 cm, ↑ 4,2 cm
incl. SMD-LED, 31 W
3.600 lm, 3.000 K



674016232



Deckenleuchte · Ceiling lamp
↔ 120 x 30 cm, ↑ 4,2 cm
incl. SMD-LED, 31 W
3.600 lm, 3.000 K



674011232



PHOENIX

Metall, Nickel matt, Acryl · metal, nickel mat, acryl ·
métal, nickel mat, acryl · metaal, nikkel mat, acryl · metal, níquel mate, acrílico ·
metallo, nichel opaco, acrílico · metal, nichel mat, acrilic · metalli, harjattu teräs, akryyli ·
metal, nikiel mat, akryl



Deckenleuchte · Ceiling lamp
Ø 30 cm, ↑ 4,2 cm
incl. SMD-LED, 15 W
1.700 lm, 3.000 K

Deckenleuchte · Ceiling lamp
Ø 45 cm, ↑ 4,2 cm
incl. SMD-LED, 26 W
3.000 lm, 3.000 K

Deckenleuchte · Ceiling lamp
Ø 62 cm, ↑ 4,2 cm
incl. SMD-LED, 31 W
3.600 lm, 3.000 K

Deckenleuchte · Ceiling lamp
↔ 30 x 30 cm, ↑ 4,2 cm
incl. SMD-LED, 15 W
1.700 lm, 3.000 K

Deckenleuchte · Ceiling lamp
↔ 45 x 45 cm, ↑ 4,2 cm
incl. SMD-LED, 26 W
3.000 lm, 3.000 K

Deckenleuchte · Ceiling lamp
↔ 62 x 62 cm, ↑ 4,2 cm
incl. SMD-LED, 31 W
3.600 lm, 3.000 K

Deckenleuchte · Ceiling lamp
↔ 120 x 30 cm, ↑ 4,2 cm
incl. SMD-LED, 31 W
3.600 lm, 3.000 K



674093007

674094507

674096207

674013007

674014507

674016207

674011207



LUGANO

Stoffschirm, Acryl · fabric shade, acryl · abat-jour tissu, acryl · Stoffen kap, acryl · Pantalla de tela, acrílico · paralume in tessuto, acrilico · abajur textil, acrilic · kangas varjostin, akryyli · Klosz z materiału, akryl



Deckenleuchte · Ceiling lamp
Ø 30 cm, ↑ 9 cm
incl. SMD-LED, 11 W
1.200 lm, 3.000 K

621911201
621911211



Deckenleuchte · Ceiling lamp
Ø 40 cm, ↑ 10,5 cm
incl. SMD-LED, 22 W
2.500 lm, 3.000 K



621912401
621912411

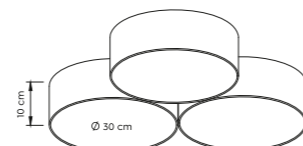

Deckenleuchte · Ceiling lamp
↔ 64,5 x 64,5 cm, ↑ 14 cm
incl. SMD-LED, 38 W
4.200 lm, 3.000 K



621910317
mehrfarbig · multicolor



Lichtfarbe stufenlos einstellbar ·
Light color infinitely variable



Integrierter Dimmer ·
Integrated dimmer



Memory Funktion ·
Memory function



Deckenleuchte · Ceiling lamp
Ø 60 cm, ↑ 10 cm
incl. SMD-LED, 42 W
4.900 lm, 3.000 - 5.000 K



621914001
621914011



Deckenleuchte · Ceiling lamp
Ø 75 cm, ↑ 10 cm
incl. SMD-LED, 60 W
5.000 lm, 3.000 - 5.000 K



621915501
621915511



TITUS

Metall, Weiß matt · metal, white mat ·
metale, blanc mat · metaal, wit mat · metal, estera blanca ·
metallo, bianco opaco · metal, alb mat · metalli, valkoinen matto ·
metal, biały mat



Lichtfarbe stufenlos einstellbar ·
Light color infinitely variable



Integrierter Dimmer ·
Integrated dimmer



Deckenleuchte · Ceiling lamp
↔ 50 x 50 cm, ↑ 4,5 cm
incl. SMD-LED, 22 W
2.800 lm, 3.000 - 6.000 K



676615031



Deckenleuchte · Ceiling lamp
↔ 75 x 75 cm, ↑ 4,5 cm
incl. SMD-LED, 36 W
3.300 lm, 3.000 - 6.000 K



676617531



Deckenleuchte · Ceiling lamp
↔ 110 x 60 cm, ↑ 4,5 cm
incl. SMD-LED, 48 W
6.000 lm, 3.000 - 6.000 K



676611031



Getrennt schaltbar ·
Separately switchable



VERUS

Metall, Acryl · metal, acryl ·
metale, acryl · metaal, acryl · metal, acrílico ·
metallo, acrilico · metal, acrylic · metalli, akryyli · metal, akryl



Lichtfarbe stufenlos einstellbar ·
Light color infinitely variable



Integrierter Dimmer ·
Integrated dimmer



07 | Nickel matt · nickel mat



32 | Schwarz matt · black mat



Deckenleuchte · Ceiling lamp
Ø 50 cm, ↑ 5,2 cm
incl. SMD-LED, 44 W
5.300 lm, 3.000 K
incl. SMD-LED, 20 W
2.000 lm, 2.700 - 6.500 K



626910307
626910332



Deckenleuchte · Ceiling lamp
Ø 70 cm, ↑ 5,8 cm
incl. SMD-LED, 70 W
8.400 lm, 3.000 K
incl. SMD-LED, 25 W
2.500 lm, 2.700 - 6.500 K



626919307
626919332



OSAKA

Chrom, Acryl, Starlight-Effekt · chrome, acryl, starlight effect ·
 chrome, acryl, effet étoile · chroom, acryl, sterlicht effect · cromo, acrílico, efecto de la luz · cromo, acrílico, effetto di stelle ·
 crom, acrílic, efect lumina stelelor · kromi, akryyli, starlight vaikutus · chrom, akryl, efekt starlight



Deckenleuchte · Ceiling lamp
 Ø 21 cm, ↑ 5 cm
 incl. SMD-LED, max. 12 W
 max. 1.160 lm, 3.000 K



678711206



Deckenleuchte · Ceiling lamp
 Ø 42 cm, ↑ 7 cm
 incl. SMD-LED, max. 27 W
 max. 3.100 lm, 3.000 - 5.500 K



678713006



Deckenleuchte · Ceiling lamp
 Ø 65 cm, ↑ 10 cm
 incl. SMD-LED, max. 91,5 W
 max. 11.000 lm, 3.000 - 5.500 K



678710006



MIKO

Chrom, Acryl, Starlight-Effekt · chrome, acryl, starlight effect ·
 chrome, acryl, effet étoile · chroom, acryl, sterlicht effect · cromo, acrílico, efecto de la luz · cromo, acrílico, effetto di stelle ·
 crom, acrílic, efect lumina stelelor · kromi, akryyli, starlight vaikutus · chrom, akryl, efekt starlight · krom, akrilik, starlight etkisi

Lichtfarbe stufenlos einstellbar ·
 Light color infinitely variable

Integrierter Dimmer ·
 Integrated dimmer

Memory Funktion ·
 Memory function



3.000 K 5.500 K

Deckenleuchte · Ceiling lamp
 Ø 85 cm, ↑ 12,5 cm
 incl. SMD-LED, 90 W
 10.800 lm, 3.000 - 5.500 K



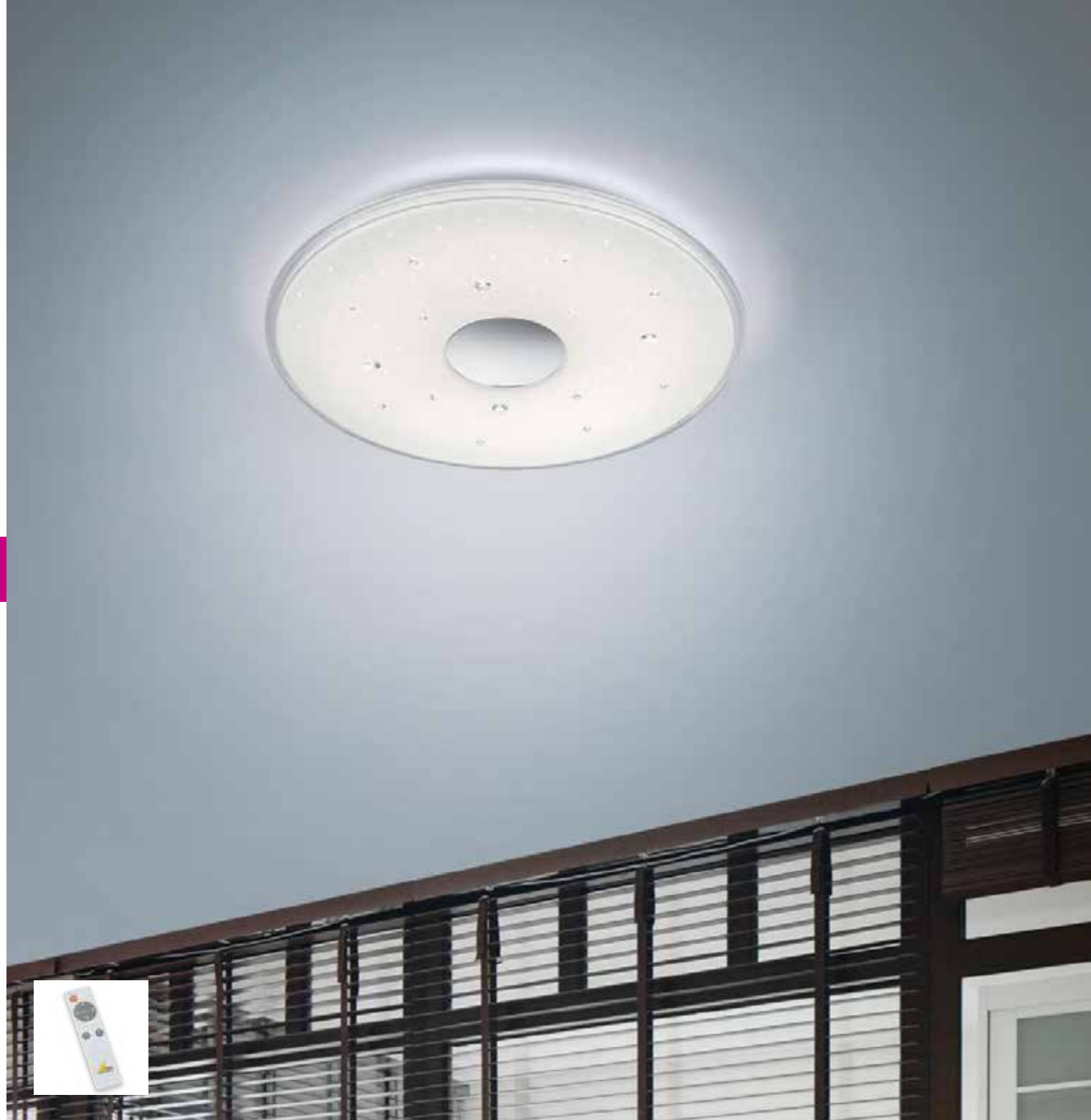

675610106



SEIKO

Acryl, Starlight-Effekt · acryl, starlight effect · acryl, effet étoile · acryl, sterlicht effect · acrílico, efecto de la luz · acrilico, effetto di stelle · acrilic, efect lumina stelelor · akryyli, starlight vaikutus · akryl, efekt starlight

 Lichtfarbe stufenlos einstellbar · Light color infinitely variable

 Integrierter Dimmer · Integrated dimmer

 Memory Funktion · Memory function



Deckenleuchte · Ceiling lamp
Ø 42,5 cm, ↓ 6 cm
incl. SMD-LED, 21,5 W
2.400 lm, 3.000-5.500 K





678513001



TOKYO

Acryl · acryl · acryl · acryl · acrílico · acrilico · acrilic · akryyli · akryl

 Lichtfarbe stufenlos einstellbar · Light color infinitely variable

 Memory Funktion · Memory function



Deckenleuchte · Ceiling lamp
Ø 60 cm, ↓ 6,5 cm
incl. SMD-LED, 43 W
4.000 lm, 3.000 - 5.500 K



628915001

SHOGUN

Acryl, Starlight-Effekt · acryl, starlight effect · acryl, effet étoile · acryl, sterlicht effect · acrílico, efecto de la luz · acrilico, effetto di stelle · acrilic, efect lumina stelelor · akryyli, starlight vaikutus · akryl, efekt starlight

 Lichtfarbe stufenlos einstellbar · Light color infinitely variable

 Integrierter Dimmer · Integrated dimmer

 Memory Funktion · Memory function

Deckenleuchte · Ceiling lamp

Ø 42,5 cm, ↑ 6 cm
incl. SMD-LED, 21,5 W
2.400 lm, 3.000-5.500 K





628513001



SAMURAI

Acryl, Starlight-Effekt · acryl, starlight effect · acryl, effet étoile · acryl, sterlicht effect · acrílico, efecto de la luz · acrilico, effetto di stelle · acrilic, efect lumina stelelor · akryyli, starlight vaikutus · akryl, efekt starlight

 Lichtfarbe stufenlos einstellbar · Light color infinitely variable

 Integrierter Dimmer · Integrated dimmer

 Memory Funktion · Memory function

Deckenleuchte · Ceiling lamp

↔ 42,5 x 42,5 cm, ↑ 6 cm
incl. SMD-LED, 21,5 W
2.400 lm, 3.000-5.500 K





628613001



NAGANO

Acryl, Starlight-Effekt · acryl, starlight effect · acryl, effet étoile · acryl, sterlicht effect · acrílico, efecto de la luz · acrilico, effetto di stelle · acrilic, efect lumina stelelor · akryyli, starlight vaikutus · akryl, efekt starlight

 Lichtfarbe stufenlos einstellbar · Light color infinitely variable

 Integrierter Dimmer · Integrated dimmer

 Memory Funktion · Memory function



Deckenleuchte · Ceiling lamp

Ø 80 cm, ↑ 10,8 cm
incl. SMD-LED, max. 72 W
max. 8.500 lm, 3.000 - 5.500 K



677718000



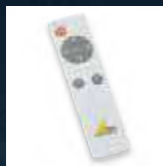

LUNAR

Kunststoff · plastic ·
plastique · kunststof · plástico · plastica · plastic · muovi · plastik · plastik

Mondphasen individuell einstellbar · Phases of the moon individually adjustable ·
Phases de lune réglables · Maanstanden apart instelbaar ·
Fases lunares ajustables individualmente · Fasi lunari regolabili individualmente ·
Fazele lunii reglabile individual · Kuun vaiheet erikseen säädettävissä ·
Cykl księżyca indywidualnie regulowany



Musterschutz ·
Registered model



Integrierter Dimmer ·
Integrated dimmer



Deckenleuchte · Ceiling lamp
Ø 40 cm, ↑ 10 cm
incl. SMD-LED, 22 W
2.460 lm, 3.000 K



627514000



Deckenleuchte · Ceiling lamp
Ø 60 cm, ↑ 12 cm
incl. SMD-LED, 40 W
3.500 lm, 3.000 K



627516000

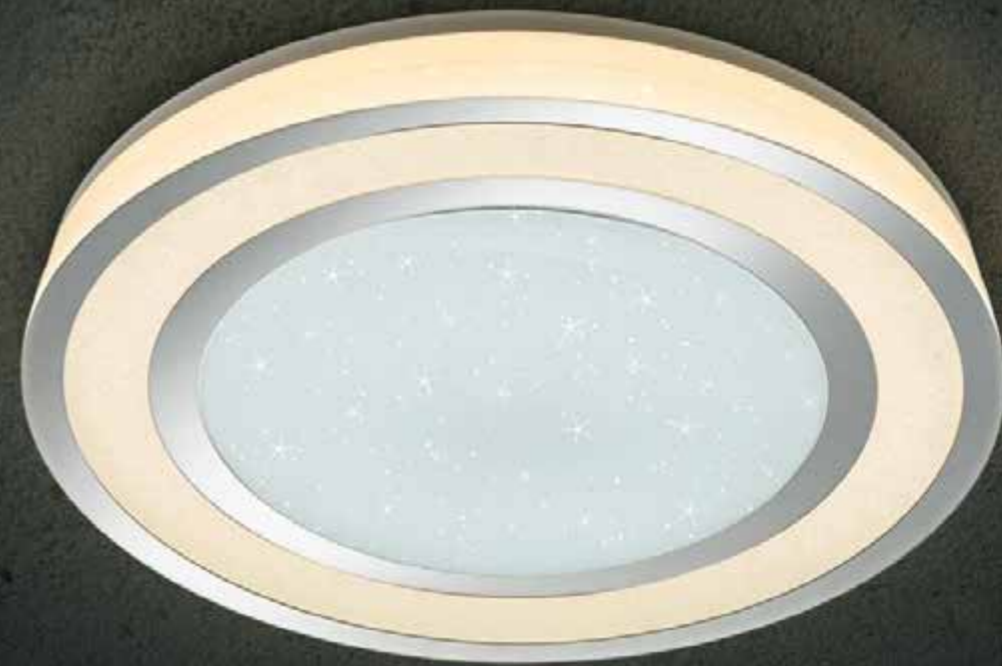

NORIAKI

Chrom, Acryl, Starlight-Effekt · chrome, acryl, starlight effect ·
chrome, acryl, effet étoile · chroom, acryl, sterlicht effect ·
cromo, acrílico, efecto de la luz · cromo, acrílico, effetto di stelle ·
crom, acrílic, efect lumina stelelor · kromi, akryyli, starlight vaikutus ·
chrom, akryl, efekt starlight



Lichtfarbe stufenlos einstellbar ·
Light color infinitely variable



Integrierter Dimmer ·
Integrated dimmer



Memory Funktion ·
Memory function



Getrennt schaltbar ·
Separately switchable



3.000 K

5.500 K



Deckenleuchte · Ceiling lamp
Ø 59,5 cm, ↑ 10 cm
incl. SMD-LED, 40 W
4.750 lm, 3.000-5.500 K



679210106



GONZALO

Kunststoff, Weiß oder titanfarbig · plastic, white or titan ·
 plastique, blanc ou titane · kunststof, wit of titaan · plástico, blanco o titán ·
 plastica, bianco o titano · plastic, alb sau titaniu · muovi, valkoinen tai titaani ·
 plastik, biały lub tytanowy



Dimmbar ·
 Dimmable



Deckenleuchte · Ceiling lamp
 Ø 29 cm, ↑ 8 cm
 incl. SMD-LED, 9 W
 900 lm, 3.000 K



626510987



Deckenleuchte · Ceiling lamp
 Ø 34 cm, ↑ 9 cm
 incl. SMD-LED, 12 W
 1.050 lm, 3.000 K



626511287



Deckenleuchte · Ceiling lamp
 Ø 42 cm, ↑ 10 cm
 incl. SMD-LED, 25 W
 2.300 lm, 3.000 K



626512587

CESAR

Chrom, Acryl mit Kristalleffekt · chrome, broken glass optic ·
 chrome, optique verre pilé · chroom, Gebroken glas optiek · cromo, Efecto cristal roto ·
 cromo, effetto ottico vetro rotto · crom, aspect de sticla sparta · kromi, lasi efekti optiikka · chrom, Optyczne rozbite szkło

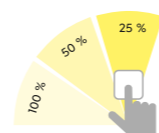

SWITCH DIMMER



Deckenleuchte · Ceiling lamp
 Ø 26 cm, ↑ 3 cm
 incl. SMD-LED, 13 W
 1.500 lm, 3.000 K



656411506



Deckenleuchte · Ceiling lamp
 Ø 40 cm, ↑ 3 cm
 incl. SMD-LED, 22 W
 2.700 lm, 3.000 K



656412406



Deckenleuchte · Ceiling lamp
 ↔ 30 x 30 cm, ↑ 3 cm
 incl. SMD-LED, 16 W
 1.900 lm, 3.000 K



656511806



Deckenleuchte · Ceiling lamp
 ↔ 40 x 40 cm, ↑ 3 cm
 incl. SMD-LED, 22 W
 2.700 lm, 3.000 K



656512006



FERNANDO

Metall, Weiß matt oder Schwarz matt · metal, white mat or black mat ·
 metale, blanc mat ou noir mat · metaal, wit mat of mat zwart ·
 metal, estera blanca o estera negra · metallo, bianco opaco o nero opaco ·
 metal, alb mat sau negru mat · metalli, valkoinen matto tai musta matto ·
 metal, biały mat lub czarny mat

Empfohlen:
 recommended: LED GU10, 5 W
 400 lm, 3.000 K



956-5936



31 | Weiß matt · white mat



32 | Schwarz matt · black mat



Deckenleuchte · Ceiling lamp
 ↔ 23 x 20 cm, ↑ 15 cm
 excl. 3 x GU10, max. 35 W

604900331
 604900332



Deckenleuchte · Ceiling lamp
 ↔ 37 x 30 cm, ↑ 15 cm
 excl. 6 x GU10, max. 35 W



604900631
 604900632



31 | Weiß matt · white mat



32 | Schwarz matt · black mat



34 | Schwarz-Weiß · black-white



80 | Schwarz-Gold · black-gold

COOKIE

Metall, Weiß matt oder Schwarz matt · metal, white mat or black mat ·
 metale, blanc mat ou noir mat · metaal, wit mat of mat zwart · metal, estera blanca o estera negra · metallo, bianco opaco o nero opaco ·
 metal, alb mat sau negru mat · metalli, valkoinen matto tai musta matto · metal, biały mat lub czarny mat



Deckenleuchte · Ceiling lamp
 ↔ 9,6 cm, ↓ 12,5 cm
 excl. 1 x GU10, max. 35 W



612900131
 612900132
 612900134
 612900180



Deckenleuchte · Ceiling lamp
 ↔ 17,8 x 9,6 cm, ↓ 12,5 cm
 excl. 2 x GU10, max. 35 W



612900231
 612900232



Deckenleuchte · Ceiling lamp
 ↔ 17,8 x 17,8 cm, ↓ 12,5 cm
 excl. 4 x GU10, max. 35 W



612900431
 612900432

Empfohlen:
 recommended: LED GU10, 5 W
 400 lm, 3.000 K



956-5936



31 | Weiß matt · white mat



32 | Schwarz matt · black mat



34 | Schwarz-Weiß · black-white



80 | Schwarz-Gold · black-gold

BISCUIT

Metall, Weiß matt oder Schwarz matt · metal, white mat or black mat ·
 metale, blanc mat ou noir mat · metaal, wit mat of mat zwart · metal, estera blanca o estera negra · metallo, bianco opaco o nero opaco ·
 metal, alb mat sau negru mat · metalli, valkoinen matto tai musta matto · metal, biały mat lub czarny mat

Empfohlen:
 recommended: LED GU10, 5 W
 400 lm, 3.000 K
  **956-5936**



Deckenleuchte · Ceiling lamp
 ↔ 9,6 x 9,6 cm, ↓ 12,5 cm
 excl. 1 x GU10, max. 35 W



613000131
 613000132
 613000134
 613000180



Deckenleuchte · Ceiling lamp
 ↔ 17,8 x 9,6 cm, ↓ 12,5 cm
 excl. 2 x GU10, max. 35 W



613000231
 613000232



Deckenleuchte · Ceiling lamp
 ↔ 17,8 x 17,8 cm, ↓ 12,5 cm
 excl. 4 x GU10, max. 35 W



613000431
 613000432



QUINTA

rostfarbig, Glas alabasterfarbig · rusty, alabaster-coloured glass ·
rouille, verre couleur albâtre · roestkleur, albastkleurig glas · óxido, vidrio de color alabastro ·
ruggine, vetro colore alabastro · ruginiu, sticla culoare alabastru · rustiikki, lasi alabasteri väri · miedz, szkło alabaster kolor



Deckenleuchte · Ceiling lamp
Ø 33 cm, ↑ 20 cm
excl. 2 x E27, max. 42 W



608100224



Deckenleuchte · Ceiling lamp
Ø 42 cm, ↑ 32 cm
excl. 3 x E27, max. 60 W



608100324



Empfohlen:
recommended: Filament-LED E27, 4 W
470 lm, 2.700 K



987-400

JOHANN

Metall, Schwarz matt, Grau antik oder Kupfer antik · metal, black mat, antique grey or antique copper ·
métal, noir mat, gris ancien ou cuivre ancien · metaal, mat zwart, antiek grijs of antiek koper · metal, estera negra, gris antiguo
o cobre antiguo · metallo, nero opaco, grigio antico o rame antico · metal, negru mat, antic gri sau cupru antic ·
metalli, mattamusta, antiikki harmaa tai antiikki kupari · metal, czarny mat, starodawny szary lub antyczne miedzi



32 | Schwarz matt ·
black mat



61 | Grau antik ·
antique grey



62 | Kupfer antik ·
antique copper



Deckenleuchte · Ceiling lamp
Ø 30 cm, ↑ 18 cm
excl. 1 x E27, max. 60 W



606903032



Deckenleuchte · Ceiling lamp
Ø 40 cm, ↑ 17 cm
excl. 1 x E27, max. 60 W



606900132
606900161
606900162



Deckenleuchte · Ceiling lamp
Ø 50 cm, ↑ 18 cm
excl. 1 x E27, max. 60 W



606905032

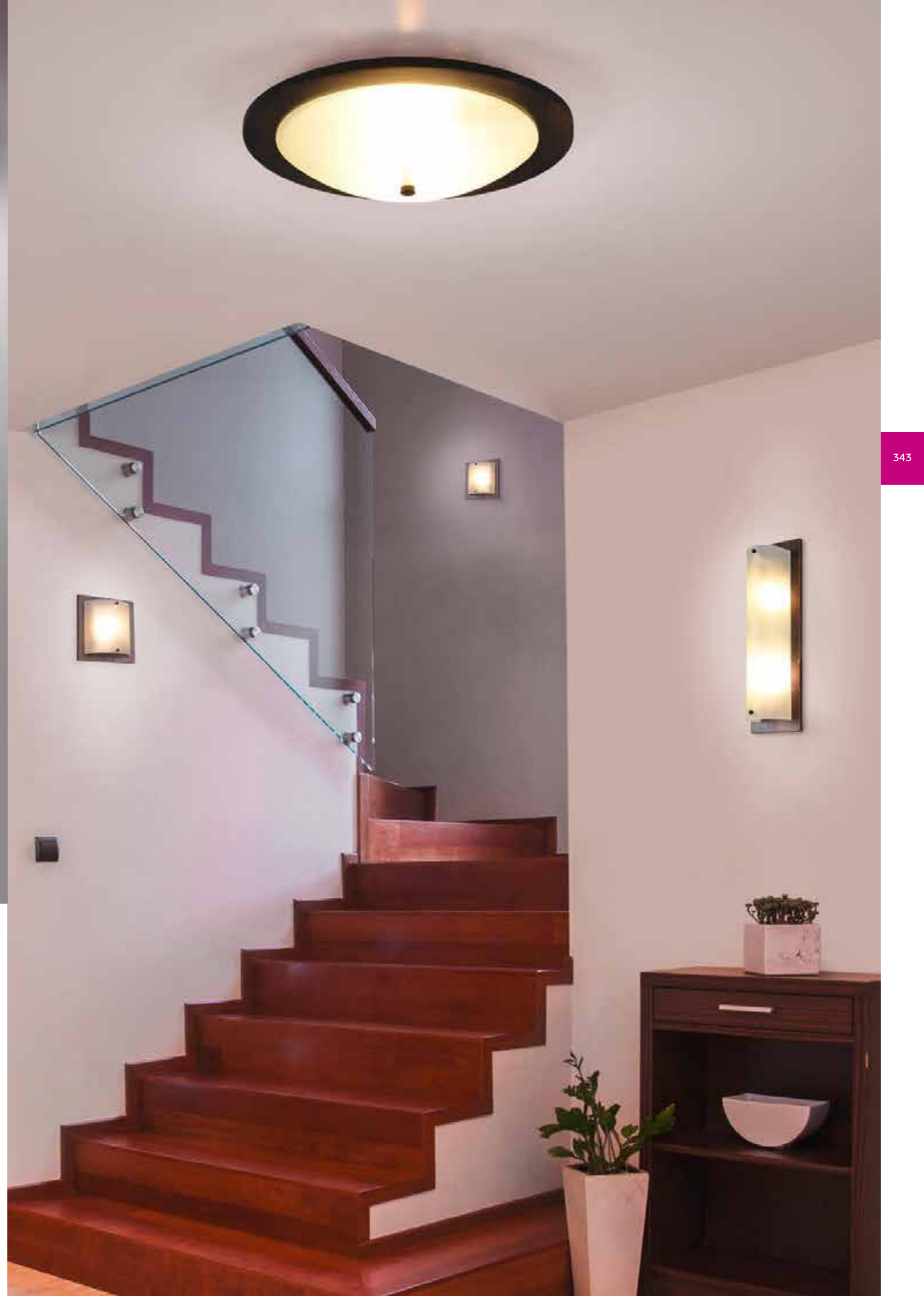

PALI

Holz, Glas satiniert · wood, satinated glass ·
 bois, Verre satiné · hout, Gesatineerd glas · maderas, Vidrio satinado ·
 di legno, Vetro satinato · lemn, Sticla satinata · puu, Satinoitu lasi ·
 drewno, Szkło satynowe



30 | Holz naturbelassen · wood natural finish



56 | Holz dunkel · old wood



Wandleuchte · Wall lamp
 ↑ 25 x 25 cm, ↗ 9 cm
 excl. 1 x E27, max. 40 W



212600130
 212600156



Wandleuchte · Wall lamp
 ↑ 45 x 14 cm, ↗ 10,5 cm
 excl. 2 x E27, max. 40 W



212600230
 212600256



Deckenleuchte · Ceiling lamp
 Ø 32 cm, ↑ 9 cm
 excl. 2 x E27, max. 25 W



612600230
 612600256

LANA

Glas Weiß matt oder alabasterfarbig · glass white mat or alabaster · coloured · verre blanc mat ou couleur albâtre · glas wit mat of albastkleurig · vidrio estera blanca o Color alabastro · vetro bianco opaco o color alabastro · sticla alb mat sau Colorat în alabastru · lasi mattavalkoinen tai alabasterin värinen · szkło biały mat lub kolor alabastrowy



07



01



344

Deckenleuchte · Ceiling lamp
Ø 25 cm, ↑ 9 cm
excl. 1 x E27, max. 40 W



6196011-01

Deckenleuchte · Ceiling lamp
Ø 25 cm, ↑ 9 cm
excl. 1 x E27, max. 40 W



6196011-07

345

PRIMO

Metall, Glas · metal, glass ·
metale, verre · metaal, glas · metal, vidrio · metallo, vetro ·
metal, sticla · metalli, lasi · metal, szkło



01 | Weiß · white



07 | Nickel matt · nickel mat



Deckenleuchte · Ceiling lamp
Ø 30 cm, ↑ 7,5 cm
excl. 1 x E27, max. 60 W



6101011-01
6101011-07



ADRIAN

Glas alabasterfarbig · alabaster-coloured glass ·
verre couleur albâtre · albastkleurig glas · vidrio de color alabastro ·
vetro colore alabastro · sticla culoare alabastru · lasi alabasteri väri ·
szkło alabaster kolor



Deckenleuchte · Ceiling lamp
Ø 30 cm, ↑ 9 cm
excl. 1 x E27, max. 40 W



6105011-01



Deckenleuchte · Ceiling lamp
Ø 40 cm, ↑ 10 cm
excl. 2 x E27, max. 40 W



6105021-01

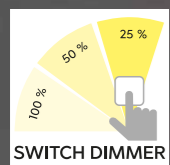

RAVEN

Schiefer, Schwarz · Shale, black · Ardoise, noir · Leisteen, zwart · Pizarra, negro · Ardesia, nero · Ardezie, negru · Savi, musta · łupek, czarny



Wandleuchte · Wall lamp
Ø 20 cm, √ 3,6 cm
incl. SMD-LED, 9 W
1.000 lm, 3.000 K



224290102



Wandleuchte · Wall lamp
↔ 25 x 12 cm, √ 3,6 cm
incl. SMD-LED, 9 W
1.000 lm, 3.000 K



224210102

CONCHA

rostfarbig, Weiß matt oder Anthrazit · rusty, white mat or anthracite · rouille, blanc mat ou antracite · roestkleur, wit mat of antraciet · óxido, estera blanca o antracita · ruggine, bianco opaco o antracite · ruginiu, alb mat sau antracit · rustiikki, mattavalkoinen tai antrasiitti · miedź, biały mat lub antracyt

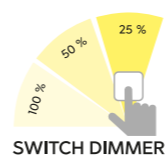

SWITCH DIMMER



24 | rostfarbig · rusty



31 | Weiß matt · white mat



42 | Anthrazit · anthracite



Wandleuchte · Wall lamp
↔ 28 x 8 cm, √ 4,5 cm
incl. 2 x SMD-LED, 6 W
2 x 600 lm, 3.000 K



225172924
225172931
225172942



Wandleuchte · Wall lamp
↔ 47 x 8 cm, √ 4,5 cm
incl. 2 x SMD-LED, 9 W
2 x 1.000 lm, 3.000 K



225174724
225174731
225174742

MIGUEL

Metall, Weiß matt oder Schwarz matt · metal, white mat or black mat · metale, blanc mat ou noir mat · metaal, wit mat of mat zwart · metal, estera blanca o estera negra · metallo, bianco opaco o nero opaco · metal, alb mat sau negru mat · metalli, valkoinen matto tai musta matto · metal, biały mat lub czarny mat

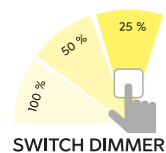

SWITCH DIMMER



348

Wandleuchte · Wall lamp

↔ 20,5 x 16,5 cm, ↗ 8,3 cm
incl. SMD-LED, 2 x 6 W
2 x 600 lm, 3.000 K



224910231 | Weiß matt · white mat

224910232 | Schwarz matt · black mat

349

LOUIS

Metall · metal · metale · metaal · metallo · metal · metalli · metal · metal

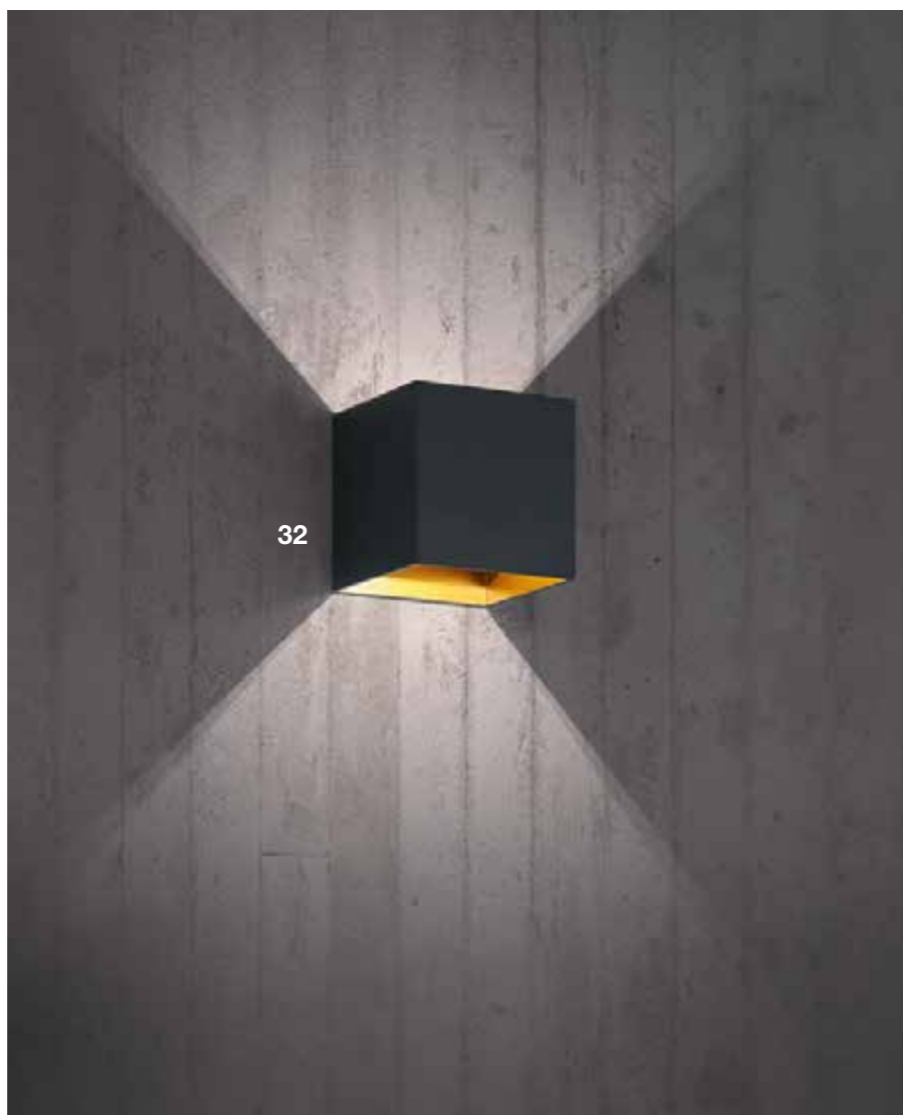
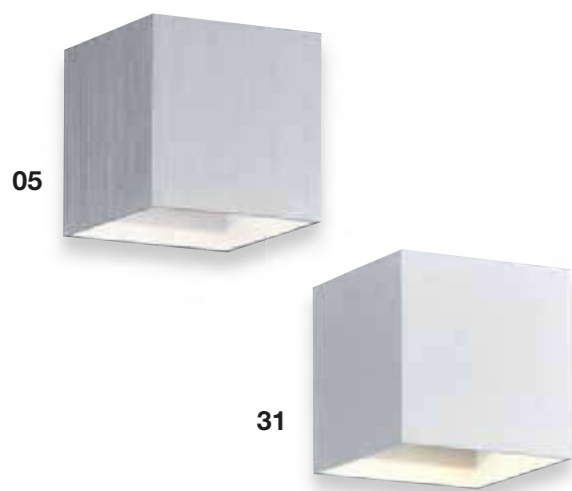

Wandleuchte · Wall lamp

↑ 10 x 10 cm, ↗ 10 cm
incl. 1 x OSRAM-LED, 4,3 W
430 lm, 3.000 K



223310105 | Aluminium gebürstet · brushed aluminium

223310131 | Weiß matt · white mat

223310132 | Schwarz matt · black mat

LACAPO

Metall · metal · metale · metaal · metallo · metal · metalli · metal



Wandleuchte · Wall lamp

↔ 10,5 cm, ↓ 6 cm, ↗ 15 cm
incl. SMD-LED, 4,3 W
430 lm, 3.000 K



223410131 | Weiß matt · white mat

223410132 | Schwarz matt · black mat

WALES

Nickel matt · nickel mat ·
nickel mat · nikkell mat · níquel mate ·
nichel opaco · nichel mat · harjattu teräs · nikiel mat



350

Wandleuchte · Wall lamp
↔ 9 cm, ↑ 9 cm, ↗ 5,8 cm
incl. 2 x SMD-LED, 3,1 W
2 x 310 lm, 3.000 K



225510207



PLATON

Aluminium gebürstet, Acryl · brushed aluminium, acryl ·
aluminium balayé, acryl · geborsteld aluminium, acryl ·
aluminio pulido, acrílico · alluminio spazzolato, acrilico ·
aluminu lucios, acrilic · harjattu alumiini, akryyli ·
aluminium szczotkowane, akryl



Wandleuchte · Wall lamp
↔ 13 x 18 cm, ↗ 9 cm
incl. 1 x SMD-LED, 4,3 W
430 lm, 3.000 K



274670105

Wandleuchte · Wall lamp
↔ 30 x 18 cm, ↗ 11 cm
incl. 2 x SMD-LED, 4,3 W
2 x 430 lm, 3.000 K



274670205



ADRIANO

Aluminium gebürstet oder Weiß · brushed aluminium or white ·
aluminium balayé ou blanc · geborsteld aluminium of wit ·
aluminio pulido o blanco · alluminio spazzolato o bianco ·
aluminu lucios sau alb · harjattu alumiini tai valkoinen ·
aluminium szczotkowane lub biały



01 | Weiß · white



05 | Aluminium gebürstet · brushed aluminium



Wandleuchte · Wall lamp
↔ 30 x 6 cm, ↗ 8 cm
incl. 2 x SMD-LED, 3,1 W
2 x 310 lm, 3.000 K



220810201
220810205

351



Wandleuchte · Wall lamp
 ↔ 12 x 12 cm, √ 10 cm
 incl. SMD-LED, 4,3 W
 430 lm, 3.000 K



224810132
 224810167



ARINO

Metall, Holz · metal, wood ·
 metale, bois · metaal, hout · metal, madera ·
 metallo, di legno · metal, lemn · metalli, puu ·
 metal, drewno

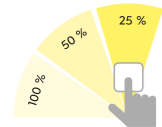

SWITCH DIMMER



32 | Schwarz matt · black matt



67 | Nickel antik · nickel antique



Wandleuchte · Wall lamp
 ↔ 35,2 x 12 cm, √ 10 cm
 incl. SMD-LED, 13,5 W
 1.500 lm, 3.000 K



224819132
 224819167



CLEO

Metall, goldfarbig · metal, gold ·
metale, or · metaal, goud · metal, oro · metallo, oro ·
metal, aur · metalli, kultaa · metal, złota

 Up and down Beleuchtung ·
Up and down lighting

Empfohlen:
recommended: LED GU10, 4,5 W
345 lm, 3.000 K



956-55



Wandleuchte · Wall lamp
↓ 15 x 8 cm, ↗ 8 cm
excl. 2 x GU10, max. 35 W



206500279



Wandleuchte · Wall lamp
↓ 16,5 x 6 cm, ↗ 10 cm
excl. 2 x GU10, max. 35 W



206400279



CHIROS

Metall, goldfarbig, Glas satiniert · metal, gold, satinated glass ·
metale, or, verre satiné · metaal, goud, gesatineerd glas · metal, oro, vidrio satinado ·
metallo, oro, vetro satinato · metal, aur, sticla satinata · metalli, kultaa, satinoitu lasi ·
metal, złota, szkło satynowe



Wandleuchte · Wall lamp
Ø 22 cm, ↗ 6,5 cm
incl. 1 x SMD-LED, 8 W
800 lm, 3.000 K



224110179



Deckenleuchte · Ceiling lamp
Ø 32 cm, ↓ 6 cm
incl. 1 x SMD-LED, 12 W, 1.280 lm
incl. 1 x SMD-LED, 3,5 W, 3500 K

624110279

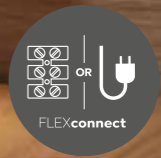

Seite/page 580

MARRIOT

Nickel matt oder goldfarbig, Stoffschirm · nickel mat or gold, fabric shade ·
 nickel mat ou or, abat-jour tissu · nikkel mat of goud, Stoffen kap · níquel mate o oro, Pantalla de tela ·
 nichel opaco o oro, paralume in tessuto · nichel mat sau aur, abajur textil ·
 harjattu teräs tai kultaa, kangas varjostin · nikiel mat lub złota, Klosz z materiału

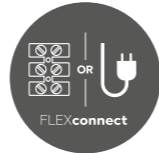

Seite/page 580



07 | Nickel matt · nickel mat



79 | goldfarbig · gold



Getrennt schaltbar · Separately switchable

Wandleuchte · Wall lamp
 ↑ 30,8 x 14 cm, ↗ 17,6 cm
 incl. 1 x SMD-LED, 3,1 W
 310 lm, 3.000 K
 excl. 1 x E14, max. 40 W



271470207
 271470279

JORDAN

Nickel matt, Weiß matt oder Schwarz matt, Acryl · nickel mat, white mat or black mat, acryl ·
 nickel mat, blanc mat ou noir mat, acryl · nikkel mat, wit mat of mat zwart, acryl ·
 níquel mate, estera blanca o estera negra, acrílico · nichel opaco, bianco opaco o nero opaco, acrilico ·
 nichel mat, alb mat sau negru mat, acrilic · harjattu teräs, mattavalkoinen tai mattamusta, akryyli ·
 nikiel mat, biały mat lub czarny mat, akryl



Getrennt schaltbar · Separately switchable



07 | Nickel matt · nickel mat



31 | Weiß matt · white mat

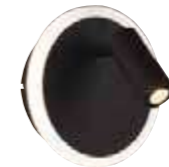

32 | Schwarz matt · black mat

Wandleuchte · Wall lamp
 Ø 15 cm, ↗ 12 cm
 incl. 1 x SMD-LED, 5 W
 550 lm, 3.000 K
 incl. 1 x SMD-LED, 2 W
 200 lm, 3.000 K



229210207
 229210231
 229210232



MARIO

Metall, Weiß matt oder Schwarz matt · metal, white mat or black mat ·
metale, blanc mat ou noir mat · metaal, wit mat of mat zwart ·
metal, estera blanca o estera negra · metallo, bianco opaco o nero
opaco · metal, alb mat sau negru mat · metalli, valkoinen matto
tai musta matto · metal, biały mat lub czarny mat

 Getrennt schaltbar ·
Separately switchable

 31 | Weiß matt · white mat

 32 | Schwarz matt · black mat

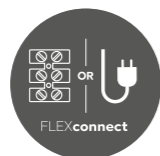

Seite/page 580



Wandleuchte · Wall lamp
Ø 16 cm, √ 10,5 cm
incl. 1 x SMD-LED, 6 W
600 lm, 3.000 K
incl. 1 x SMD-LED, 2,3 W
200 lm, 3.000 K

 **222370231**
222370232

ELEMENT

Metall, Weiß matt oder Schwarz matt · metal, white mat or black mat ·
metale, blanc mat ou noir mat · metaal, wit mat of mat zwart · metal, estera blanca o estera negra ·
metallo, bianco opaco o nero opaco · metal, alb mat sau negru mat ·
metalli, valkoinen matto tai musta matto · metal, biały mat lub czarny mat

 USB Anschluss mit Ladefunktion ·
Recharging USB connection

 Getrennt schaltbar ·
Separately switchable

 indirekte Beleuchtung ·
indirect lighting

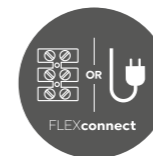

Seite/page 580



Wandleuchte · Wall lamp
∫ 20 x 16 cm, √ 14 cm
incl. 1 x SMD-LED, 3 W
220 lm, 3.000 K
incl. 2 x SMD, 1,5 W
2 x 150 lm, 3.000 K

 **222570231** | Weiß matt · white mat
222570232 | Schwarz matt · black mat



CUADRO

Altmessing oder Nickel matt · old brass or nickel mat ·
laiton fumé ou nickel mat · oud brons of nikkel mat · bronce viejo o níquel mate ·
ottone invecchiato o nichel opaco · bronz antic sau nichel mat ·
antiikkimessinki tai harjattu teräs · patyna lub nikiel mat



Wandleuchte · Wall lamp
↔ 48 x 10,5 cm, ↗ 10 cm
incl. 1 x SMD-LED, 8 W
900 lm, 3.000 K

225210104 | Altmessing · old brass
225210107 | Nickel matt · nickel mat



CURTIS

Altmessing, Nickel matt, Messing matt oder Schwarz matt · old brass, nickel mat, brass mat or black mat ·
Laiton fumé, Nickel mat, Laiton mat ou Noir mat · Oud brons, Nikkel mat, Messing mat of Mat zwart ·
Bronce viejo, Níquel mate, Bronce mate o Estera negra · Ottone invecchiato, Nichel opaco, Ottone satinato o Nero opaco ·
Bronz antic, Nichel mat, Bronz mat sau Negru mat · Antiikkimessinki, Harjattu teräs, Mattamessinki tai mattamusta ·
Patyna, Nikiel mat, Mosiądz mat lub Czarny mat

 Integrierter Dimmer ·
Integrated dimmer



04 | Altmessing ·
old brass



07 | Nickel matt ·
nickel mat



08 | Messing matt ·
brass mat

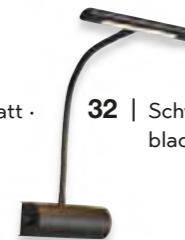

32 | Schwarz matt ·
black mat

Wandleuchte · Wall lamp
↔ 18 cm, ↗ max. 35 cm
incl. SMD-LED, 4 W
430 lm, 3.000 K



279770104
279770107
279770108
279770132

BALDO

Metall, schwarz matt · metal, black mat ·
metale, noir mat · metaal, mat zwart · metal, estera negra ·
metallo, nero opaco · metal, negru mat ·
metalli, mattamusta · metal, czarny mat

Empfohlen:
recommended: Filament LED E27, 7 W
806 lm, 2.700 K



987-6810



362

Wandleuchte · Wall lamp
↔ 28 cm, ↑ 28,3 cm, ↙ max. 150 cm,
excl. 1 x E27, max. 40 W



200600132

363

LINE

Metall, schwarz matt · metal, black mat ·
metale, noir mat · metaal, mat zwart · metal, estera negra ·
metallo, nero opaco · metal, negru mat ·
metalli, mattamusta · metal, czarny mat

Empfohlen:
recommended: Filament LED E27, 7 W
806 lm, 3.000 K



988-600



Wandleuchte · Wall lamp
↔ 5,5 cm, ↑ 25 cm, ↙ max. 150 cm
excl. 1 x E27, max. 10 W



200200132

BOLDER

Metall, schwarz matt · metal, black mat ·
metale, noir mat · metaal, mat zwart · metal, estera negra ·
metallo, nero opaco · metal, negru mat · metalli, mattamusta ·
metal, czarny mat

Empfohlen:
recommended: Filament LED E27, 8 W
806 lm, 2.700 K



985-6810

Wandleuchte · Wall lamp
↔ 35 cm, ↑ 29 cm, ↙ max. 150 cm
excl. 1 x E27, max. 40 W



200300132

CAMPO

rostfarbig, Scavo glas · rusty, scavo glass ·
rouille, verre scavo · roestkleur, scavo glas ·
óxido, vidrio scavo · ruggine, vetro scavo ·
ruginiu, sticla scavo · rustiikki, scavo-lasi ·
miedz, szkło scavo

Empfohlen:
recommended: Filament LED E14, 4 W
470 lm, 2.700 K



989-400



364

Wandleuchte · Wall lamp
↑ 44 cm, ↔ 12 cm, ↗ 16 cm
excl. 1 x E14, max. 40 W



200970124

DIVO

Chrom, Glas · chrome, glass ·
chrome, verre · chroom, glas · cromo, vidrio ·
cromo, vetro · crom, sticla · kromi, lasi · chrom, szkło

Empfohlen:
recommended: LED E14, 3,5 W
320 lm, 3.000 K



989-40

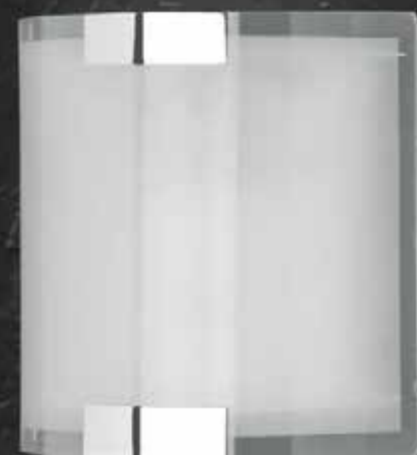

Wandleuchte · Wall lamp
↔ 20 x 20 cm, ↗ 7,5 cm
excl. 1 x E14, max. 40 W



2522011-06

PURA

Metall, Glas · metal, glass ·
metale, verre · metaal, glas · metal, vidrio ·
metallo, vetro · metal, sticla · metalli, lasi · metal, szkło

Empfohlen:
recommended: Filament LED E27, 7 W
806 lm, 2.700 K



987-6810



04 | Altmessing · old brass



07 | Nickel matt · nickel mat



Wandleuchte · Wall lamp
↑ 20 cm, ↔ 20 cm, ↗ 7,5 cm
excl. 1 x E27, max. 40 W



212700104
212700107



Wandleuchte · Wall lamp
↑ 40 cm, ↔ 20 cm, ↗ 7,5 cm
excl. 2 x E27, max. 25 W



212700204
212700207

365

LILLY

Empfohlen:
recommended: Filament LED E27, 7 W
680 lm, 2.700 K



988-710



366 Deckenleuchte · Ceiling lamp
Ø 30 cm, ↑ 6 cm
excl. 1 x E27, max. 40 W



603300101

Überstreichbare Gipsleuchten · Gypsum lights that can be painted · Lampes en gypse à peindre · overschilderbare gipslampen · Lámparas de yeso que pueden pintarse · Le lampade in gesso possono essere verniciate · Lāmpi de ipsos, ce pot fi vopsite · Maalattava kipsivalaisin · Oświetlenie gipsowe, które można pomalować

ZAZOU

Empfohlen:
recommended: LED GU10, 5 W
400 lm, 3.000 K



955-50



Wandleuchte · Wall lamp
↑ 16,5 cm, ↔ 7,5 cm, ↗ 7 cm
excl. 2 x GU10, max. 10 W



201100201



ROMA

Überstreichbare Gipsleuchte · Gypsum lights that can be painted · Lampes en gypse à peindre · overschilderbare gipslampen · Lámparas de yeso que pueden pintarse · Le lampade in gesso possono essere verniciate · Lāmpi de ipsos, ce pot fi vopsite · Maalattava kipsivalaisin · Oświetlenie gipsowe, które można pomalować

Empfohlen:
recommended: LED E14, 4,9 W
470 lm, 3.000 K



983-60



Wandleuchte · Wall lamp
↔ 24,5 x 9,5 cm, ↗ 12 cm
excl. 1 x E14, max. 28 W



201000101





WANDA

Metall, Kunststoff · metal, plastic ·
 metale, plastique · metaal, kunststof ·
 metal, plástico · metallo, plastica ·
 metal, plastic · metalli, muovi ·
 metal, plastik

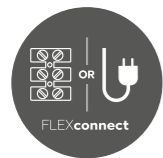

Seite/page 580



Wandleuchte · Wall lamp
 † 23,5 cm, ↔ 8,5 cm, √ 22 cm
 excl. 1 x GU10, max. 10 W



- 202670107 | Nickel matt · nickel mat
- 202670108 | Messing matt · brass mat
- 202670131 | Weiß matt · white mat
- 202670132 | Schwarz matt · black mat



Empfohlen:
 recommended: LED GU10, 3 W
 250 lm, 3.000 K



956-30

Klemmspot · clamp spot
 † 20 cm, ↔ 7 cm, √ 22 cm
 excl. 1 x GU10, max. 10 W



- 202620131 | Weiß matt · white mat
- 202620132 | Schwarz matt · black mat

LEVISTO

Glas alabasterfarbig · alabaster-coloured glass ·
verre couleur albâtre · albastkleurig glas ·
vidrio de color alabastro · vetro colore alabastro ·
sticla culoare alabastru · lasi alabasteri väri ·
szkło alabaster kolor

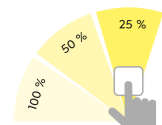

SWITCH DIMMER

Empfohlen:
recommended: LED E14, 4,9 W
470 lm, 3.000 K



983-66

Steckerleuchte · Plug light

↑ 40 cm, ↔ 4,7 cm, ∠ max. 22 cm
incl. 1 x LED E14, 28 W
470 lm, 3.000 K



891010107



LIGARA

Kunststoff · plastic ·
plastique · kunststof · plástico ·
plastica · plastic · muovi · plastik

Empfohlen:
recommended: LED E14, 3,5 W
320 lm, 3.000 K



983-40

Steckerleuchte · Plug light

↑ 28 cm, ↔ 6,9 cm, ∠ max. 20 cm
excl. 1 x E14, max. 40 W



8911211-07



ECCO

Nickel matt · nickel mat ·
nickel mat · nikkell mat · níquel mate ·
nichel opaco · nichel mat · harjattu teräs · nikiel mat

Unterbauleuchte · cabinet lighting

↔ 12,4 x 11,5 cm, ↑ 4,3 cm
incl. 3 x SMD-LED, 3 W
3 x 200 lm, 3.000 K



273370307 Set: 3 St./3 pc.





ARAGON

Kunststoff, Weiß oder titanfarbig · plastic, white or titan ·
 plastique, blanc ou titane · kunststof, wit of titaan · plástico, blanco o titán ·
 plastica, bianco o titano · plastic, alb sau titaniu · muovi, valkoinen tai titaani ·
 plastik, biały lub tytanowy



01 | Weiß · white

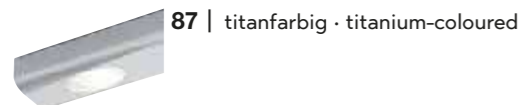

87 | titanfarbig · titanium-coloured



Unterbauleuchte · cabinet lighting
 ↔ 40 x 4 cm, ↓ 2 cm
 incl. 3 x SMD-LED, 1 W
 3 x 80 lm, 3.000 K



273170301
 273170387



Unterbauleuchte · cabinet lighting
 ↔ 55 x 4 cm, ↓ 2 cm
 incl. 4 x SMD-LED, 1 W
 4 x 90 lm, 3.000 K



273170401
 273170487



incl.

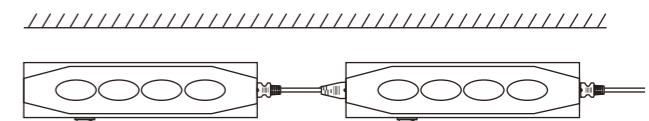
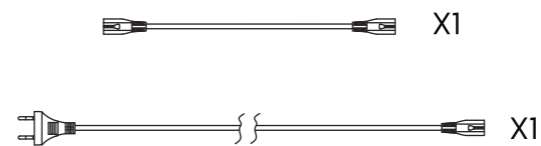



RAMON

Kunststoff · plastic ·
plastique · kunststof · plástico ·
plastica · plastic · muovi · plastik



Unterbauleuchte · cabinet lighting
↔ 28 x 2,5 cm, ↓ 4 cm
incl. 1 x SMD-LED, 3,5 W
400 lm, 3.000 K



273070401



Unterbauleuchte · cabinet lighting
↔ 51 x 2,5 cm, ↓ 4 cm
incl. 1 x SMD-LED, 6,5 W
700 lm, 3.000 K



273070701



Unterbauleuchte · cabinet lighting
↔ 84 x 2,5 cm, ↓ 4 cm
incl. 1 x SMD-LED, 12 W
1.400 lm, 3.000 K



273071301



Unterbauleuchte · cabinet lighting
↔ 114 x 2,5 cm, ↓ 4 cm
incl. 1 x SMD-LED, 16,5 W
1.850 lm, 3.000 K



273071801



ALINO

Kunststoff, Weiß oder titanfarbig · plastic, white or titan ·
plastique, blanc ou titane · kunststof, wit of titaan · plástico, blanco o titán ·
plastica, bianco o titano · plastic, alb sau titaniu · muovi, valkoinen tai titaani ·
plastik, biały lub tytanowy



01 | Weiß · white



87 | titanfarbig · titanium-coloured



Unterbauleuchte · cabinet lighting
↔ 34 x 7 cm, ↓ 2 cm
incl. SMD-LED, 4 W
350 lm, 3.000 K



272970401
272970487



Unterbauleuchte · cabinet lighting
↔ 55 x 7 cm, ↓ 2 cm
incl. SMD-LED, 7 W
600 lm, 3.000 K



272970701
272970787



Tisch- & Stehleuchten

- Table- & floor lamps
- Lampes de table & lampadaires
- Tafel- & vloerlampen
- Sobremesas y lámparas de pie
- Lampade da tavolo e piantane
- Veioze si lampadare
- Pöytä- & lattia
- Stołowe i podłogowe



31 | Weiß matt / Schirm Grau · white mat / shade grey



41 | Schwarz matt / Schirm Taupe · black mat / shade taupe

MANSUR

Metall, Stoffschirm · metal, fabric shade ·
metale, abat-jour tissu · metaal, Stoffen kap · metal, Pantalla de tela ·
metallo, paralume in tessuto · metal, abajur textil ·
metalli, kangas varjostin · metal, Klosz z materiału

Stehleuchte · Floor lamp
‡ 210 cm, Ø cm, † 200 cm
excl. 1 x E27, max. 40 W



419200131
419200141

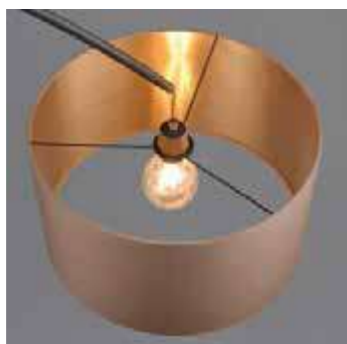



CLARK

Metall, Schwarz matt, Stoffschirm mehrfarbig · metal, black mat, fabric shade multicolor ·
 metale, noir mat, abat-jour tissu multicolore · metaal, mat zwart, Stoffen kap multicolor ·
 metal, estera negra, Pantalla de tela multicolor · metallo, nero opaco, paralume in
 tessuto multicolore · metal, negru mat, abajur textil multicolor · metalli, mattamusta,
 kangas varjostin monivärinen · metal, czarny mat, Klosz z materiału multi-kolor



Stehleuchte · Floor lamp
 ↑ 198 cm, ↔ 35 cm, ↗ 170 cm
 excl. 3 x E27, max. 60 W



401700317



TRACY

Metall, Schwarz matt, Stoffschirm · metal, black mat, fabric shade ·
 metale, noir mat, abat-jour tissu · metaal, mat zwart, Stoffen kap · metal, estera negra, Pantalla de tela ·
 metallo, nero opaco, paralume in tessuto · metal, negru mat, abajur textil · metalli, mattamusta, kangas varjostin ·
 metal, czarny mat, Klosz z materiału



Stehleuchte · Floor lamp
 ↑ 175 cm, Ø 40 cm, ↗ max. 105 cm
 excl. 1 x E27, max. 60 W



462100132



Seite/page 580



CASSIO

Metall, Stoff · metal, fabric ·
metale, tissu · metaal, textiel · metal, tela ·
metallo, tessuto · metal, textil · metalli, tekstiili · metal, tkanina



07 | Nickel matt · nickel mat



08 | Messing matt · brass mat



32 | Schwarz matt · black mat



Wandleuchte · Wall lamp
↑ 27,9 cm, Ø 23 cm, ↗ 25,9 cm
excl. 1 x E27, max. 40 W



214470107
214470108
214470132



Tischleuchte · Table lamp
↑ 48 cm, Ø 28 cm
excl. 1 x E27, max. 60 W



514400107
514400108
514400132



Stehleuchte · Floor lamp
↑ 153,3 cm, Ø 50 cm
excl. 1 x E27, max. 60 W



414400107
414400108
414400132





Tischleuchte · Table lamp
 † 37 cm, Ø 20 cm
 excl. 1 x E27, max. 40 W



515790107
 515790132

Tischleuchte · Table lamp
 † 62,5 cm, Ø 40 cm
 excl. 1 x E27, max. 60 W



515700107
 515700132

Stehleuchte · Floor lamp
 † 155 cm, Ø 45,7 cm
 excl. 3 x E27, max. 40 W



415700307
 415700332

SABIA

Nickel matt oder Schwarz matt, Stoff · nickel mat or black mat, fabric ·
 nickel mat ou noir mat, tissu · nikkell mat of mat zwart, textiel ·
 níquel mate o estera negra, tela · nichel opaco o nero opaco, tessuto ·
 nichel mat sau negru mat, textil · harjattu teräs tai mattamusta, tekstiili ·
 nikiel mat lub czarny mat, tkanina





HOTEL

Metall, Stoffschirm · metal, fabric shade ·
 metale, abat-jour tissu · metaal, Stoffen kap ·
 metal, Pantalla de tela · metallo, paralume in tessuto ·
 metal, abajur textil · metalli, kangas varjostin ·
 metal, Klosz z materiału

Stehleuchte · Floor lamp
 ↑ 170 cm, Ø 40 cm, √ 35 cm
 excl. 1 x E27, max. 60 W
 excl. 1 x E14, max. 18 W



403900201
 403900208
 403900211



01 | Nickel matt, Schirm Weiß ·
 nickel mat, shade white

08 | Messing matt, Schirm Creme-Weiß ·
 brass mat, shade cream white

11 | Nickel matt, Schirm Grau ·
 nickel mat, shade grey



MOTEL

Metall, Stoffschirm · metal, fabric shade ·
 metale, abat-jour tissu · metaal, Stoffen kap · metal, Pantalla de tela · metallo, paralume in tessuto ·
 metal, abajur textil · metalli, kangas varjostin · metal, Klosz z materiału

07 | Nickel matt, Schirm Schwarz/Weiß ·
 nickel mat, shade black/white

08 | Messing matt, Schirm Schwarz/goldfarbig ·
 brass mat, shade black/gold

Stehleuchte · Floor lamp
 ↑ 164 cm, Ø 40 cm, √ 54 cm
 excl. 1 x E27, max. 60 W
 excl. 1 x E14, max. 10 W



416900207
 416900208



CLAAS

Metall, Stoff · metal, fabric ·
 metale, tissu · metaal, textiel · metal, tela ·
 metallo, tessuto · metal, textil · metalli, tekstiili ·
 metal, tkanina

USB Anschluss mit Ladefunktion ·
 Recharging USB connection

07 | Nickel matt · nickel mat

32 | Schwarz matt · black mat



Stehleuchte · Floor lamp
 ↓ 160 cm, ↔ 40 cm, ↗ 40 cm
 excl. 1 x E27, max. 60 W



400400107
 400400132

PARIS II

Nickel matt oder Messing matt · nickel mat or brass mat ·
 nickel mat ou laiton mat · nikkell mat of messing mat ·
 níquel mate o bronze mate · nichel opaco o ottone satinato ·
 nichel mat sau bronz mat · harjattu teräs tai mattamessinki ·
 nikiel mat lub mosiądz mat

07 | Nickel matt · nickel mat

08 | Messing matt · brass mat



Tischleuchte · Table lamp
 ↓ 58 cm, Ø 35 cm
 excl. 1 x E27, max. 60 W



500200107
 500200108

Stehleuchte · Floor lamp
 ↓ 160 cm, Ø 50 cm
 excl. 1 x E27, max. 60 W



400200107
 400200108

1x — 2x — 3x



Getrennt schaltbar · Separately switchable
Interrupteurs séparés · Gescheiden schakelbaar ·
Interruptores separados · Interruttori separati ·
Intrerupatoare separate · Erikseen kytkettävissä ·
Oddzileny przełącznik



NANDOR

Metall, Stoff · metal, fabric ·
metale, tissu · metaal, textiel · metal, tela ·
metallo, tessuto · metal, textil · metalli, tekstiili · metal, tkanina



Tischleuchte · Table lamp
↓ 62 cm, Ø 30 cm
incl. 2 x SMD, 3 W
2 x 300 lm, 3.000 K
excl. 1 x E27, max. 40 W



575310307
575310379



Stehleuchte · Floor lamp
↓ 160,5 cm, Ø 40 cm
incl. 2 x SMD, 7 W
2 x 700 lm, 3.000 K
excl. 1 x E27, max. 60 W



475310307
475310379

07 | Nickel matt · nickel mat

79 | goldfarbig · gold

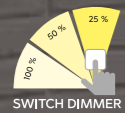

TEXEL

Metall Schwarz matt/goldfarbig · metal black mat/gold ·
 metale noir mat/or · metaal mat zwart/goud · metal estera negra/oro ·
 metallo nero opaco/oro · metal negru mat/aur · metalli musta matto/kultaa ·
 metal czarny mat/zlota



Tischleuchte · Table lamp
 † 47,5 cm, Ø 16 cm
 incl. 1 x SMD-LED, 6,8 W
 650 lm, 3.000 K



574410179



Stehleuchte · Floor lamp
 † 142,5 cm, Ø 25 cm
 incl. 1 x SMD-LED, 15 W
 1.450 lm, 3.000 K



474410179



LIÈGE

Holz, Metall, Schwarz matt/goldfarbig · wood, metal, black mat/gold ·
 bois, metale, noir mat/or · hout, metaal, mat zwart/goud ·
 madera, metal, estera negra/oro · di legno, metallo, nero opaco/oro ·
 lemn, metal, negru mat/aur · puu, metalli, mattamusta/kultaa ·
 drewno, metal, czarny mat/zlota

Empfohlen:
 recommended: Filament LED E27, 7 W
 806 lm, 2.700 K



987-6810



Stehleuchte · Floor lamp
 † 120 - 160 cm, ↔ 80 cm
 excl. 1 x E27, max. 60 W



407800132



LANCE

Metall, Chrom oder Schwarz, Glas rauchfarbig oder mehrfarbig ·
 metal, chrome or black, glass smoke or multicolor ·
 metale, chrome ou noir, verre fumé ou multicolore ·
 metaal, chrom of zwart, glas rookkleur of multicolor ·
 metal, cromo o negro, vidrio humo o multicolor ·
 metallo, cromo o nero, vetro fume' o multicolore ·
 metal, crom sau negru, sticla fumuriu sau multicolor ·
 metalli, kromi tai musta, lasi savu tai monivärinen ·
 metal, chrom lub czarny, szkło przydymiony lub multi-kolor

Stehleuchte · Floor lamp
 †156 cm, Ø 60 cm
 excl. 3 x E14, max. 28 W



403400317 | mehrfarbig · multicolor
 403400354 | rauchfarbig · smoke



Chrom, Glas rauchfarbig ·
 chrome, glass smoke



Schwarz matt, Glas multicolor ·
 black mat, glass multicolor



SOLA

Chrom, Marmor, Acryl · chrome, marble, acryl ·
 chrome, marbre, acryl · chroom, marmer, acryl ·
 cromo, mármol, acrílico · cromo, marmo, acrilico ·
 crom, marmura, acrilic · kromi, marmori, akryyli ·
 chrom, marmur, akryl

Stehleuchte · Floor lamp
 † 176 - 200 cm, † 180 cm, Ø 40 cm
 excl. 1 x E27, max. 75 W



4200011-06



ARGENTINA

Nickel matt oder Messing matt, Marmor · nickel mat or brass mat, marble ·
 nickel mat ou laitton mat, marbre · nikkell mat of messing mat, marmer · níquel mate o bronce mate, mármol ·
 nichel opaco o ottone satinato, marmo · nichel mat sau bronz mat, marmura · afstandsbediening tai geïntegreerde dimmer, marmori ·
 nikiel mat lub mosiądz mat, marmur

Stehleuchte · Floor lamp
 † 200 cm, Ø 38 cm, † 172,5 cm
 excl. 1 x E27, max. 60 W



411700107
 411700108





BANGKOK

Metall, Schwarz matt, Marmor · metal, black mat, marble ·
 métal, noir mat, marbre · metaal, mat zwart, marmer · metal, estera negra, mármol ·
 metallo, nero opaco, marmo · metal, negru mat, marmura · metalli, mattamusta, marmorì ·
 metal, czarny mat, marmur

 Integrierter Dimmer ·
 Integrated dimmer

Stehleuchte · Floor lamp
 † 180 cm, ↔ 22 x 23 cm, √ 127,5 cm
 incl. SMD-LED, 18 W
 2.200 lm, 3.000 K



426511832



SHANGHAI

Metall · metal ·
 metale · metaal · metallo ·
 metal · metalli · metal

 Integrierter Dimmer ·
 Integrated dimmer

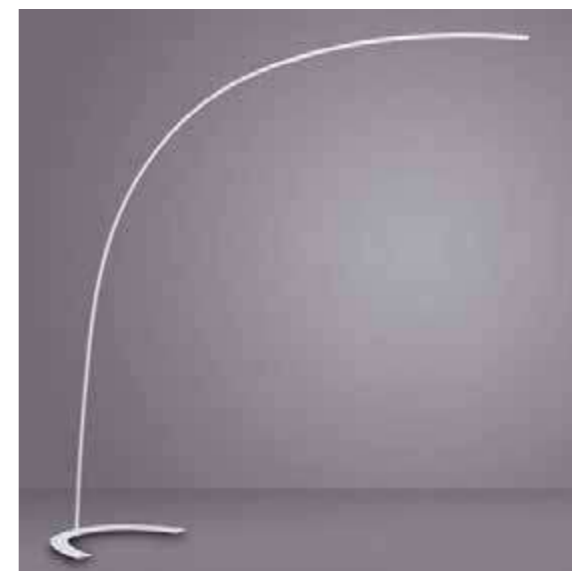

Stehleuchte · Floor lamp
 † 210 cm, ↔ 65 cm, √ 200 cm
 incl. SMD-LED, 18 W
 2.000 lm, 3.000 K



427511801
427511802



3.000 K

4.500 K

6.500 K





Dimmen und Lichtfarbe einstellen ·
 Dimming and adjusting light color ·
 Varier et choisir la couleur de la lumière ·
 Dimmen en lichtkleur instellen ·
 Atenuación y ajuste del color de la luz ·
 Variare e scegliere il colore della luce ·
 Variati lumina si ajustati culoarea luminii ·
 Himmennys ja värilämpötilan säätö vakiokytkimellä ·
 ściemniać i jasność ustawić



QUEBEC

Nickel matt oder Messing matt · nickel mat or brass mat ·
 nickel mat ou laiton mat · nikkell mat of messing mat ·
 níquel mate o bronce mate · nichel opaco o ottone satinato ·
 nichel mat sau bronz mat · harjattu teräs tai mattamessinki ·
 nikiel mat lub mosiądz mat

 Lichtfarbe einstellbar ·
 Adjustable light color

 Integrierter Dimmer ·
 Integrated dimmer

 Memory Funktion ·
 Memory function



07 | Nickel matt · nickel mat



08 | Messing matt · brass mat

Stehleuchte · Floor lamp
 ↑ 180 cm, ↗ 35 cm
 incl. SMD-LED, 35 W
 4.200 lm, 3.000 + 4.500 + 6.500 K
 incl. SMD-LED, 5,5 W
 600 lm, 3.000 + 4.500 + 6.500 K



422710307
 422710308



BRANTFORD

Metall · metal ·
metale · metaal · metal · metallo · metal · metalli · metal

Lichtfarbe einstellbar ·
Adjustable light color

Sensordimmer ·
Sensor dimmer

Memory Funktion ·
Memory function



04 | Altmessing · old brass

07 | Nickel matt · nickel mat

08 | Messing matt · brass mat

32 | Schwarz matt · black mat

Stehleuchte · Floor lamp
↓ 180 cm, ↔ 30 cm, ↗ 41,6 cm
incl. SMD-LED, 30 W
3.500 lm, 2.700 + 3.200 + 4.000 K
incl. SMD-LED, 6,5 W
650 lm, 2.700 + 3.200 + 4.000 K



425610204
425610207
425610208
425610232



GRANBY

Metall · metal ·
metale · metaal · metal ·
metallo · metal · metalli · metal



Lichtfarbe einstellbar ·
Adjustable light color



Sensordimmer ·
Sensor dimmer



Memory Funktion ·
Memory function



04 | Altmessing · old brass



07 | Nickel matt · nickel mat



08 | Messing matt · brass mat



32 | Schwarz matt · black mat

Stehleuchte · Floor lamp
↑ 180 cm, ↔ 29,5 cm, ↗ 46 cm
incl. SMD-LED, 29 W
3.400 lm, 2.700 + 3.200 + 4.000 K
incl. SMD-LED, 6,5 W
650 lm, 2.700 + 3.200 + 4.000 K



424310204
424310207
424310208
424310232





BARRIE

Metall · metal ·
metale · metaal · metal · metallo ·
metal · metalli · metal

 Lichtfarbe einstellbar ·
Adjustable light color

 Sensordimmer ·
Sensor dimmer

 Memory Funktion ·
Memory function

 **04** | Altmessing · old brass

 **07** | Nickel matt · nickel mat

 **32** | Schwarz matt · black mat



Stehleuchte · Floor lamp
↑ 181 cm, Ø 30 cm, ∟ 70 cm
incl. SMD-LED, 32 W, 3.700 lm
incl. SMD-LED, 6 W, 700 lm
2.700 + 4.000 K



424210304
424210307
424210332





CHRIS

Chrom, Acryl mit Kristalleffekt · chrome, broken glass optic · chrome, optique verre pilé · chroom, gebroken glas optiek · cromo, efecto cristal roto · cromo, effetto ottico vetro rotto · crom, aspect de sticla sparta · kromi, lasi efekti optiikka · chrom, optyczne rozbite szkło

 Integrierter Dimmer · Integrated dimmer

Deckenleuchte · Ceiling lamp
 ↑ 180 cm, ∅ 52 cm
 incl. 1 x SMD-LED, 18 W , 2.000 lm, 3.000 K
 incl. 1 x SMD-LED, 3,8 W , 350 lm, 3.000 K



478310206



SPLIT

Nickel matt · nickel mat · nickel mat · nikkell mat · níquel mate · nichel opaco · nichel mat · harjattu teräs · nikiel mat

 Lichtfarbe stufenlos einstellbar · Light color infinitely variable

 Integrierter Dimmer · Integrated dimmer

 Memory Funktion · Memory function

Stehleuchte · Floor lamp
 ↑ 181 cm, ↔ 33 cm, ∅ 43 cm
 incl. SMD-LED, 20 W
 2.000 lm, 3.000 - 6.500 K
 incl. 1 x SMD-LED, 3,5 W
 340 lm, 3.000 - 6.500 K



424910207



ARIZONA

Nickel matt oder Messing matt · nickel mat or brass mat · nickel mat ou laiton mat · nikkell mat of messing mat · níquel mate o bronze mate · nichel opaco o ottone satinato · nichel mat sau bronz mat · harjattu teräs tai mattamessinki · nikiel mat lub mosiądz mat



Sensordimmer ·
Sensor dimmer



07 | Nickel matt · nickel mat



08 | Messing matt · brass mat

Stehleuchte · Floor lamp

↑ 180 cm, Ø 25,5 cm, √ 40 cm
incl. SMD-LED, 20 W, 2.200 lm, 3.000 K
incl. 1 x SMD-LED, 5 W, 500 lm, 3.000 K



426410207
426410208



SANTO II

Metall, Glas alabasterfarbig · metal, alabaster-coloured glass · metale, verre couleur albâtre · metaal, albastkleurig glas · metal, vidrio de color alabastro · metallo, vetro colore alabastro · metal, sticla culoare alabastru · metalli, lasi alabasteri väri · metal, szkło alabaster kolor



Integrierter Dimmer ·
Integrated dimmer



07 | Nickel matt · nickel mat



28 | rostfarbig antik · antique rust

Stehleuchte · Floor lamp

↑ 180 cm, Ø 25,5 cm, √ 40 cm
incl. 4 x SMD-LED, 4,8 W, 4 x 450 lm, 3.000 K
incl. 1 x SMD-LED, 4,8 W, 450 lm, 3.000 K



421910207
421910228



BERGAMO

Nickel matt oder Messing matt · nickel mat or brass mat ·
 nickel mat ou laiton mat · nikkell mat of messing mat ·
 níquel mate o bronze mate · nichel opaco o ottone satinato ·
 nichel mat sau bronz mat · harjattu teräs tai mattamessinki ·
 nikiel mat lub mosiądz mat

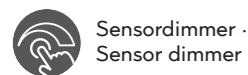

Sensordimmer ·
 Sensor dimmer



07 | Nickel matt · nickel mat

08 | Messing matt · brass mat



Tischleuchte · Table lamp
 ↓ 50 cm, ↗ 40 cm
 incl. 1 x SMD-LED, 12 W
 1.100 lm, 3.000 K



520910107
 520910108



Stehleuchte · Floor lamp
 ↓ 135 cm, ↗ 50 cm
 incl. 1 x SMD-LED, 12 W
 1.100 lm, 3.000 K



420910107
 420910108



VERONA

Nickel matt · nikkell mat ·
 nickel mat · nikkell mat · níquel mate · nichel opaco ·
 nichel mat · harjattu teräs · nikiel mat

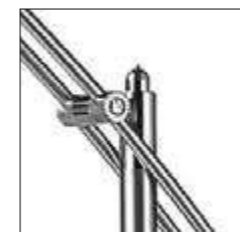

Sensordimmer · Sensor dimmer
 Variateur tactile · Touchdimmer ·
 Regulador con sensor · Touchdimmer ·
 Variator cu senzor · Kosketushimmennin ·
 Czujnik ściemniania ·



Stehleuchte · Floor lamp
 ↓ 126 cm, ↗ 60 cm
 incl. 1 x SMD-LED, 12 W
 1.100 lm, 3.000 K



420810107



MONZA

Metall · metal ·
metale · metaal · metal ·
metallo · metal · metalli · metal



Tischleuchte · Table lamp
↓ 57 cm, ↔ 19 cm, ↗ 46 cm
incl. SMD-LED, 12 W
1.400 lm, 2.300 + 3.000 + 4.000 K



523310107
523310108
523310131
523310132



Stehleuchte · Floor lamp
↓ 145 cm, ↔ 25 cm, ↗ 50 cm
incl. SMD-LED, 12 W
1.400 lm, 2.300 + 3.000 + 4.000 K



423310107
423310108
423310131
423310132



Lichtfarbe einstellbar ·
Adjustable light color



Sensordimmer ·
Sensor dimmer



07 | Nickel matt · nickel mat



31 | Weiß · white



08 | Messing matt · brass mat



32 | Schwarz matt · black mat





PAVIA

Metall, Altmessing, Schwarz matt oder Weiß matt · metal, old brass, black mat or white mat ·
 métal, laiton fumé, noir mat ou blanc mat · metaal, oud brons, mat zwart of wit mat ·
 metal, bronce viejo, estera negra o estera blanca · metallo, ottone invecchiato, nero opaco
 o bianco opaco · metal, bronz antic, negru mat sau alb mat · metalli, antiikkimessinki,
 mattamusta tai mattavalkoinen · metal, patyna, czarny mat lub biały mat

 Lichtfarbe einstellbar ·
 Adjustable light color

 Integrierter Dimmer ·
 Integrated dimmer



-  **04** | Altmessing · old brass
-  **31** | Weiß matt · white mat
-  **32** | Schwarz matt · black mat

 Tischleuchte · Table lamp
 ↑ 38,5 cm, ↔ 14 cm, √ 43 cm
 incl. SMD-LED, 12 W
 1.400 lm, 2.300 + 3.000 + 4.000 K

570310104
 570310131
 570310132

 Stehleuchte · Floor lamp
 ↑ 130,5 cm, ↔ 16 cm, √ 48 cm
 incl. SMD-LED, 12 W
 1.400 lm, 2.300 + 3.000 + 4.000 K

470310104
 470310131
 470310132





Seite/page 580



KAZAN

Metall, schwarz matt · metal, black mat ·
 metale, noir mat · metaal, mat zwart · metal, estera negra ·
 metallo, nero opaco · metal, negru mat · metalli, mattamusta ·
 metal, czarny mat



Wandleuchte · Wall lamp
 Ø 14 cm, √ max. 55 cm
 incl. 1 x SMD, 8 W
 800 lm, 3.000 K



274770132



Stehleuchte · Floor lamp
 † 121,5 cm, ↔ 24 cm, √ max. 61,5 cm
 incl. 1 x SMD, 8 W
 800 lm, 3.000 K



474790132



NARCOS

Nickel matt oder Schwarz matt · nickel mat or black mat ·
nickel mat ou noir mat · nikkell mat of mat zwart · níquel mate o estera negra ·
nichel opaco o nero opaco · nichel mat sau negru mat · harjattu teräs tai musta matto · nikiel mat lub czarny mat

 4 fach TOUCH ·
4 level Touch function

Stehleuchte · Floor lamp
↑ 154 cm, ↔ 28 cm
incl. 3 x SMD-LED, 4,7 W
3 x 470 lm, 3.000 K



473190307
473190332

 07 | Nickel matt · nickel mat

 32 | Schwarz matt · black mat



FILIGRAN

Nickel matt oder Schwarz matt · nickel mat or black mat ·
nickel mat ou noir mat · nikkell mat of mat zwart · níquel mate o estera negra ·
nichel opaco o nero opaco · nichel mat sau negru mat · harjattu teräs tai mattamusta · nikiel mat lub czarny mat

 Sensordimmer ·
Sensor dimmer

Stehleuchte · Floor lamp
↑ 162 cm, ↗ 52 cm
incl. 1 x SMD-LED, 6,5 W
700 lm, 3.000 K



420490107
420490132

 07 | Nickel matt · nickel mat

 32 | Schwarz matt · black mat





DAKOTA

Metall, schwarz matt · metal, black mat ·
 metale, noir mat · metaal, mat zwart · metal, estera negra ·
 metallo, nero opaco · metal, negru mat · metalli, mattamusta · metal, czarny mat

Empfohlen:
 recommended: LED G9, 3 W
 300 lm, 3.000 K



929-230



Stehleuchte · Floor lamp
 ↑ 155 cm, ↔ 23 cm
 excl. 3 x G9, max. 28 W



404600332



EDWARD

Metall, Schwarz matt · metal, black mat ·
 metale, noir mat · metaal, mat zwart · metal, estera negra · metallo, nero opaco ·
 metal, negru mat · metalli, mattamusta · metal, czarny mat

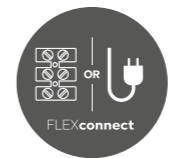

Seite/page 580



Wandleuchte · Wall lamp
 ↑ 25 cm, ↔ 12 cm, ↗ 50 cm
 excl. 1 x E14, max. 40 W



208870132



Stehleuchte · Floor lamp
 ↑ 160 cm, ↔ 38 cm
 excl. 3 x E14, max. 40 W



408800332



Tischleuchte · Table lamp
 ↑ 45 cm, ↔ 12 cm, √ 25 cm
 excl. 1 x GU10, max. 5 W



512400107
 512400108
 512400131
 512400132

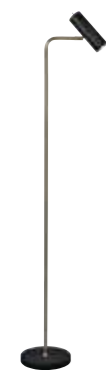

Stehleuchte · Floor lamp
 ↑ 151 cm, ↔ 23 cm, √ 39 cm
 excl. 1 x GU10, max. 5 W



412400107
 412400108
 412400131
 412400132

MARLEY

Metall · metal ·
 metals · metaal · metal · metallo · metal · metalli · metal

Empfohlen:
 recommended: LED GU10, 4,5 W
 345 lm, 3.000 K



956-55



07 | Nickel matt · nickel mat



08 | Messing matt / Schwarz matt
 brass matt / black mat



31 | Weiß matt · white mat



32 | Schwarz matt · black mat



FREDDY

Nickel matt, Glas matt · nickel mat, mat glass ·
 nickel mat, verre mat · nikkell mat, mat glas · níquel mate, vidrio mate ·
 nichel opaco, vetro sabbaiato · nichel mat, sticla mata ·
 harjattu teräs, mattalasi · nikiel mat, szkło matowane



Stehleuchte · Floor lamp
 † 125 cm, ∅ 55 cm
 incl. 2 x LED E14, 4 W
 2 x 320 lm, 3.000 K



424810207



Stehleuchte · Floor lamp
 † 150 cm, ∅ 55 cm
 incl. 1 x LED E14, 4 W
 320 lm, 3.000 K



424810107

incl.
 LED E14, 3,5 W
 320 lm, 3.000 K



983-40



ICARO

Metall, Glas matt · metal, mat glass ·
 metale, verre mat · metaal, mat glas · metal, vidrio mate ·
 metallo, vetro sabbaiato · metal, sticla mata · metalli, mattalasi · metal, szkło matowane

Stehleuchte · Floor lamp
 † 165 cm, ∅ 54 cm
 excl. 1 x E27, max. 60 W



4035011-04
 4035011-07
 4035011-08



04 | Altmessing · old brass



07 | Nickel matt · nickel mat



08 | Messing matt · brass mat





BALE

Stoff · fabric ·
tissu · textiel · tela ·
tessuto · textil · tekstiili · tkanina



12 | Blau · blue

49 | Pistaziengrün · pistachio green

77 | Ultimate Grau · ultimate grey

83 | Illuminate Gelb · illuminate yellow

Tischleuchte · Table lamp
↑ 40 cm, Ø 24 cm
excl. 2 x E27, max. 40 W



505200112
505200149
505200177
505200183

NOLA

Metall, Weiß matt oder Schwarz matt · metal, white mat or black mat ·
metale, blanc mat ou noir mat · metaal, wit mat of mat zwart ·
metal, estera blanca o estera negra · metallo, bianco opaco o nero opaco ·
metal, alb mat sau negru mat · metalli, valkoinen matto tai musta matto ·
metal, biały mat lub czarny mat



31 | Weiß matt · white mat



32 | Schwarz matt · black mat



Tischleuchte · Table lamp
↑ 30,5 cm, Ø 20 cm
excl. 1 x E14, max. 40 W



506200131
506200132



Tischleuchte · Table lamp
↑ 45 cm, Ø 30 cm
excl. 1 x E27, max. 40 W



506290131
506290132



4 fach TOUCH ·
4 level Touch function

CURTIS

Altmessing, Nickel matt oder Messing matt · old brass, nickel mat or brass mat ·
laiton fumé, nickel mat ou laiton mat · oud brons, nikkell mat of messing mat ·
bronce viejo, níquel mate o bronce mate · ottone invecchiato, nichel opaco o
ottone satinato · bronz antic, nichel mat sau bronz mat · antiikkimessinki,
harjattu teräs tai mattamessinki · patyna, nikiel mat lubmosiędz mat



04 | Altmessing · old brass



07 | Nickel matt · nickel mat



08 | Messing matt · brass mat



32 | Schwarz matt · black mat



Tischleuchte · Table lamp
↓ 35 cm, ↔ 18 cm, ↗ max. 15 cm
incl. SMD-LED, 4 W
400 lm, 3.000 K



579790104
579790107
579790108
579790132



Wandleuchte · Wall lamp
↓ 35 cm, ↔ 18 cm, ↗ max. 35 cm
incl. SMD-LED, 4 W
430 lm, 3.000 K



279770104
279770107
279770108
279770132



Integrierter Dimmer ·
Integrated dimmer



DONNA

Metall, Glas alabasterfarbig · metal, alabaster-coloured glass ·
metale, verre couleur albâtre · metaal, albastkleurig glas ·
metal, vidrio de color alabastro · metallo, vetro colore
alabastro · metal, sticla culoare alabastru · metalli, lasi
alabasteri väri · metal, szkło alabaster kolor



4 fach TOUCH ·
4 level Touch function



07 | Nickel matt · nickel mat



08 | Messing matt · brass mat



432 Tischleuchte · Table lamp

↑ 30 cm, Ø 22,5 cm
incl. 1 x SMD-LED, 4,5 W
450 lm, 3.000 K



525790107
525790108

JOOST II

Nickel matt, Glas matt · nickel mat, mat glass ·
nickel mat, verre mat · nikkel mat, mat glas ·
níquel mate, vidrio mate · nichel opaco, vetro sabbato ·
nichel mat, sticla mata · harjattu teräs, mattalasi ·
nikiel mat, szkło matowane



On/Off Touch Funktion ·
On/Off Touch function

Empfohlen:
recommended: LED E27, 8,5 W
806 lm, 3.000 K



988-10

Tischleuchte · Table lamp
↑ 39 cm, Ø 19 cm
excl. 1 x E27, max. 40 W



592300107



VENTURA

Metall, Glas matt · metal, mat glass ·
metale, verre mat · metaal, mat glas · metal, vidrio mate ·
metallo, vetro sabbato · metal, sticla mata · metalli, mattalasi ·
metal, szkło matowane



4 fach TOUCH ·
4 level Touch function



03 | Messing poliert · polished brass



07 | Nickel matt · nickel mat



Tischleuchte · Table lamp
↑ 29 cm, Ø 15,5 cm
incl. 1 x SMD-LED, 4 W
350 lm, 3.000 K



529990103
529990107





433

CRISTO

Chrom oder Nickel matt, Glas · chrome or nickel mat, glass · chrome ou nickel mat, verre · chrom of nikkell mat, glas · cromo o níquel mate, vidrio · cromo o nichel opaco, vetro · crom sau nichel mat, sticla · kromi tai harjattu teräs, lasi · chrom lub nikiel mat, szkło

 4 fach TOUCH · 4 level Touch function

 **00** | Chrome, Transparent · chrome, transparent

 **07** | Nickel matt, Glas weiß · nickel mat, glass white



Tischleuchte · Table lamp
 ↑ 14,5 cm, Ø 11 cm
 incl. 1 x SMD-LED, 4,3 W
 430 lm, 3.000 K



529690100
 529690107

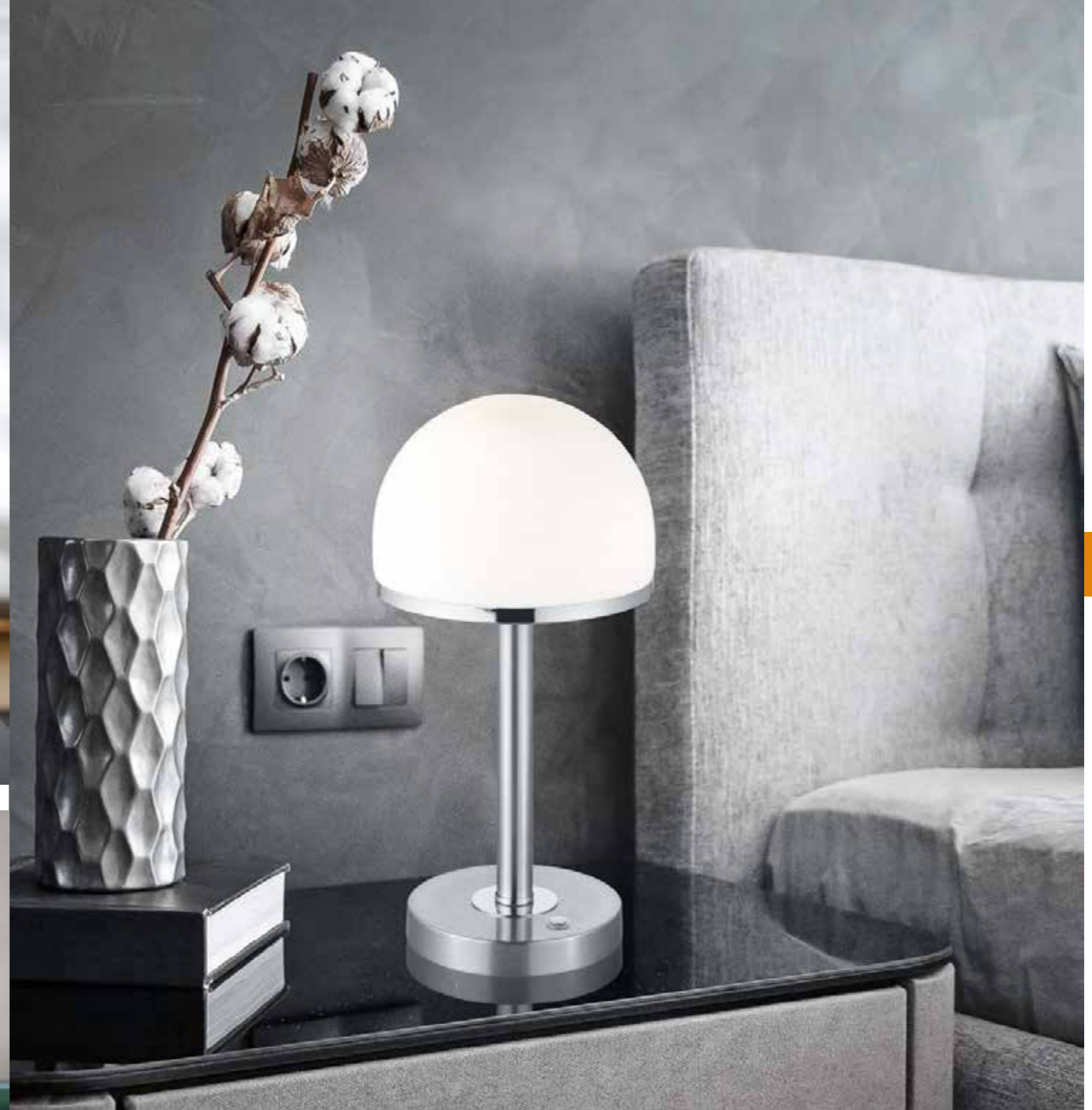

EMERALD

Metall, Glas matt · metal, mat glass · metale, verre mat · metaal, mat glas · metal, vidrio mate · metallo, vetro sabbaiato · metal, sticla mata · metalli, mattalasi · metal, szkło matowane

 4 fach TOUCH · 4 level Touch function

 **06** | Chrom · chrome

 **07** | Nickel matt · nickel mat

Tischleuchte · Table lamp
 ↑ 29 cm, Ø 15 cm
 incl. 1 x SMD-LED, 4,5 W
 450 lm, 3.000 K



525490106
 525490107



BERLIN

Metall, Glas matt · metal, mat glass · metale, verre mat · metaal, mat glas · metal, vidrio mate · metallo, vetro sabbaiato · metal, sticla mata · metalli, mattalasi · metal, szkło matowane · metal, mat cam

 4 fach TOUCH · 4 level Touch function



Tischleuchte · Table lamp
 ↑ 39 cm, Ø 19,5 cm
 incl. 1 x SMD-LED, 4,5 W
 450 lm, 3.000 K



527590107 | Nickel matt · nickel mat
 527590179 | goldfarbig · gold

ARY II

Metall, Glas matt · metal, mat glass ·
metale, verre mat · metaal, mat glas · metal, vidrio mate ·
metallo, vetro sabbaiato · metal, sticla mata ·
metalli, matalasi · metal, szkło matowane

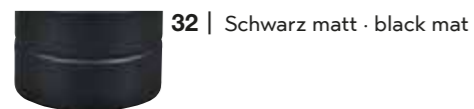
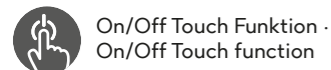

Tischleuchte · Table lamp

↑ 15 cm, Ø 9 cm
excl. 1 x E14, max. 40 W



591000107
591000132

TILL II

Metall, Glas matt · metal, mat glass ·
metale, verre mat · metaal, mat glas · metal, vidrio mate ·
metallo, vetro sabbaiato · metal, sticla mata ·
metalli, matalasi · metal, szkło matowane

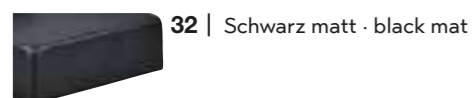

Tischleuchte · Table lamp

↑ 14,5 cm, ↔ 10 x 15 cm
excl. 1 x E14, max. 40 W



590200107
590200132



DAVI II

Metall, Glas matt · metal, mat glass ·
metale, verre mat · metaal, mat glas · metal, vidrio mate ·
metallo, vetro sabbaiato · metal, sticla mata · metalli, matalasi ·
metal, szkło matowane

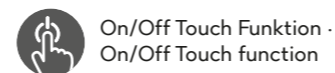

Empfohlen:
recommended: LED E14, 4,9 W
470 lm, 3.000 K



983-66



Tischleuchte · Table lamp

↑ 15 cm, ↔ 12 x 15 cm
excl. 1 x E14, max. 40 W



590100107
590100132

LUIS II

Metall, Glas alabasterfarbig · metal, alabaster-coloured glass ·
metale, verre couleur albâtre · metaal, albastkleurig glas ·
metal, vidrio de color alabastro · metallo, vetro colore
alabastro · metal, sticla culoare alabastru · metalli, lasi
alabasteri väri · metal, szkło alabaster kolor

 On/Off Touch Funktion ·
On/Off Touch function

 06 | Chrom · chrome

 07 | Nickel matt · nickel mat

 08 | Messing matt · brass mat

438 Tischleuchte · Table lamp
↑ 32 cm, Ø 12
excl. 1 x E14, max. 40 W



Empfohlen:
recommended: LED E14, 4,9 W
470 lm, 3.000 K



 983-66

595700106
595700107
595700108



MATS II

Nickel matt, Stoff · nickel mat, fabric ·
nickel mat, tissu · nikkel mat, textiel · níquel mate, tela ·
nichel opaco, tessuto · nichel mat, textil ·
harjattu teräs, tekstiili · nikiel mat, tkanina

 On/Off Touch Funktion ·
On/Off Touch function



01 | Weiß · white



42 | Anthrazit · anthacite



15 | Grün · green



19 | Türkis · turquoise

Tischleuchte · Table lamp
↑ 24 cm, Ø 14 cm
excl. 1 x E14, max. 40 W



Empfohlen:
recommended: LED E14, 4,9 W
470 lm, 3.000 K



 983-66

599700101
599700115
599700119
599700142



FYNN II

Metall, Glas alabasterfarbig · metal, alabaster-coloured glass ·
metale, verre couleur albâtre · metaal, albastkleurig glas ·
metal, vidrio de color alabastro · metallo, vetro colore alabastro ·
metal, sticla culoare alabastru · metalli, lasi alabasteri väri ·
metal, szkło alabaster kolor

 On/Off Touch Funktion ·
On/Off Touch function

Empfohlen:
recommended: LED E14, 4,9 W
470 lm, 3.000 K



 983-66



06



08



18



24

Tischleuchte · Table lamp
↑ 21 cm, Ø 15 cm
excl. 1 x E14, max. 40 W



599100106 | Chrom · chrome
599100107 | Nickel matt · nickel mat
599100108 | Messing matt · brass mat
599100118 | Orange · orange
599100124 | rostfarbig · rusty



AMSTERDAM

Metall, Weiß oder Schwarz · metal, white or black ·
metale, blanc ou noir · metaal, wit of zwart · metal, blanco o negro ·
metallo, bianco o nero · metal, alb sau negru · metalli, valkoinen tai musta ·
metal, biały lub czarny



Tischleuchte · Table lamp
↑ max. 90 cm, ↗ max. 90 cm, Ø 18 cm
incl. 1 x COB-LED, 5 W
500 lm, 3.000 K



527920101 | Weiß · white
527920102 | Schwarz · black

AVA

Kunststoff · plastic ·
plastique · kunststof · plástico ·
plastica · plastic · muovi · plastik



Lichtfarbe einstellbar ·
Adjustable light color



Sensordimmer ·
Sensor dimmer



USB Anschluss mit Ladefunktion ·
Recharging USB connection



Memory Funktion ·
Memory function



Tischleuchte · Table lamp
↑ 40,4 cm, ↔ 17,1 cm, ↗ 30,5 cm
incl. SMD-LED, 5,2 W
600 lm, 3.000 + 4.000 + 6.500 K



523090131 | Weiß matt · white mat
523090132 | Schwarz matt · black mat



VARIO

Metall, Kunststoff, titanfarbig · metal, plastic, titan ·
métal, plastique, titane · metaal, kunststof, titaan · metal, plástico, titán ·
metallo, plastica, titano · metal, plastic, titaniu · metalli, muovi, titaani ·
metal, plastik, tytanowy

 Flexibel ·
Flexible



Tischleuchte · Table lamp
↑ max. 64,5 cm, ↗ max. 50 cm
incl. SMD-LED, 3,6 W
480 lm, 3.000 K



522520187



RADO

Metall, Kunststoff · metal, plastic ·
metale, plastique · metaal, kunststof · metal, plástico ·
metallo, plastica · metal, plastic · metalli, muovi · metal, plastik

 Lichtfarbe einstellbar ·
Adjustable light color

 4 fach TOUCH ·
4 level Touch function

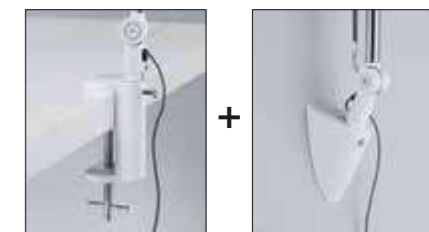

 31 | Weiß matt · white mat

 32 | Schwarz matt · black mat

Tischleuchte · Table lamp
↑ 70 cm, ↗ 38 cm
incl. 1 x SMD-LED, 5 W
700 lm, 3.000 + 4.000 + 5.000 K



527690131
527690132



KIMI

Metall, Holz · metal, wood ·
metale, bois · metaal, hout · metal, madera ·
metallo, di legno · metal, lemn · metalli, puu · metal, drewno



Tischleuchte · Table lamp
↑ max. 50 cm, Ø 16 cm, ∟ max. 37,5 cm
excl. 1 x E27, max. 42 W



508300131 | Weiß matt · white mat
508300132 | Schwarz matt · black mat

Empfohlen:
recommended: LED E27, 4 W
320 lm, 3.000 K



986-40



PERRY

Metall · metal ·
metale · metaal · metal · metallo · metal · metalli · metal



Empfohlen:
recommended: LED E27, 4,9 W
470 lm, 3.000 K



987-60

Tischleuchte · Table lamp
↑ 46 cm, ↔ 16 cm, ∟ 28 cm
excl. 1 x E27, max. 10 W



504900104 | Altmessing · old brass
504900107 | Nickel matt · nickel mat
504900131 | Weiß matt · white mat
504900132 | Schwarz matt · black mat

POLO

Kunststoff · plastic ·
plastique · kunststof · plástico ·
plastica · plastic · muovi · plastik



Lichtfarbe einstellbar ·
Adjustable light color



4 fach TOUCH ·
4 level Touch function



446 Tischleuchte · Table lamp

↑ 41 cm, ↗ 40 cm
incl. 1 x SMD-LED, 5 W
550 lm, 3.000 + 4.000 + 5.000 K



527090111 | Grau · grey
527090131 | Weiß matt · white mat

FLEXO

Metall, Kunststoff · metal, plastic ·
metale, plastique · metaal, kunststof · metal, plástico ·
metallo, plastica · metal, plastic · metalli, muovi ·
metal, plastik



01 | Weiß · white

02 | Schwarz · black

17 | mehrfarbig · multicolor

47 | silberfarbig · silver-coloured

Tischleuchte · Table lamp

↑ 30 cm, ↗ 30 cm
excl. 1x E14, max. 18 W



5028010-01
5028010-02
5028010-17
5028010-47



LUPO

Kunststoff · plastic ·
plastique · kunststof · plástico · plastica · plastic · muovi · plastik



4 fach TOUCH ·
4 level Touch function



01 | Weiß · white



02 | Schwarz · black

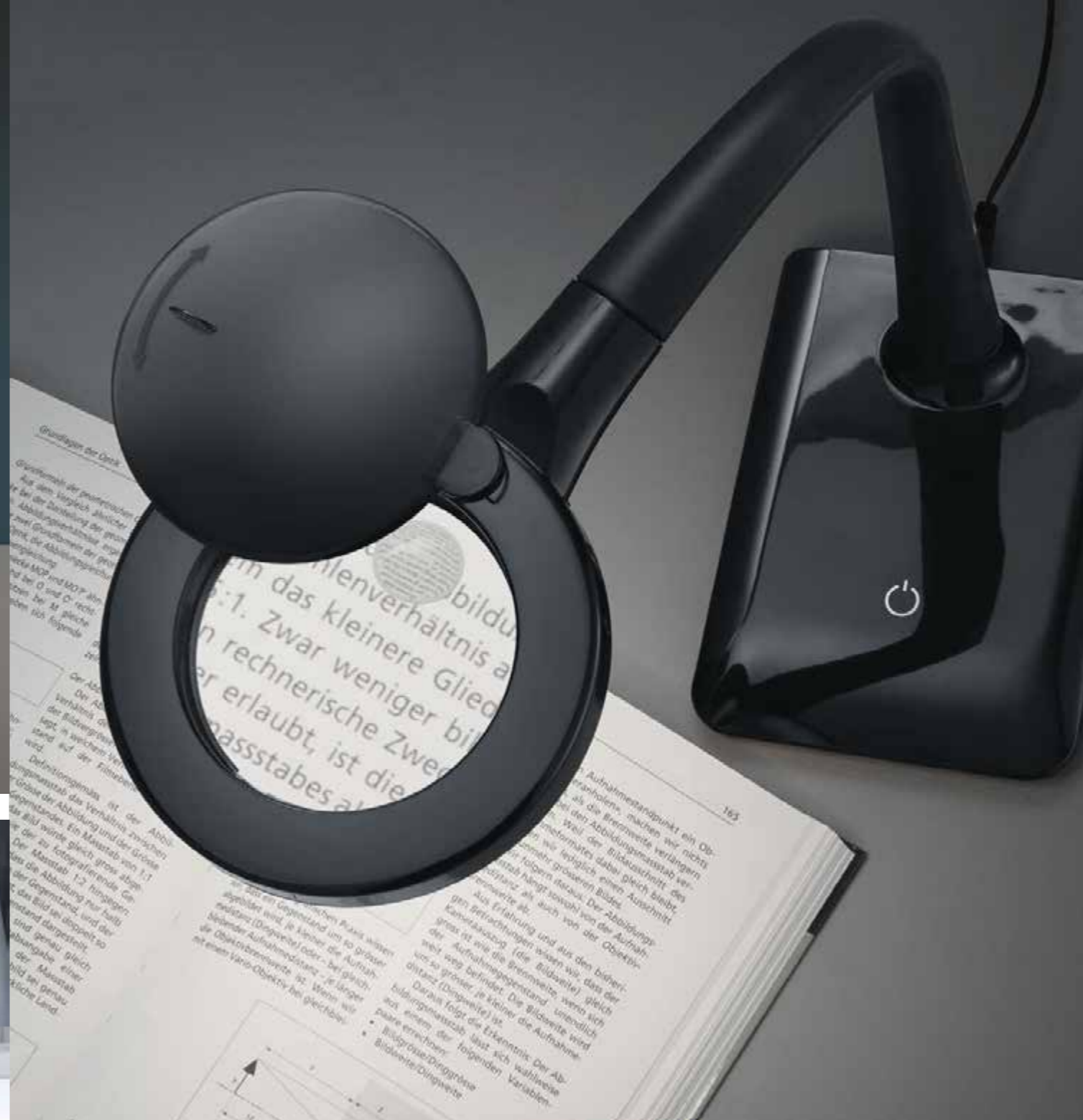

Tischleuchte · Table lamp
↑ 35 cm, Ø 13,5 cm, ↗ 30 cm
incl. 1 x SMD-LED, 5 W
550 lm, 3.500 K



527290101
527290102



PRONTO

Metall, Kunststoff · metal, plastic ·
metale, plastique · metaal, kunststof · metal, plástico ·
metallo, plastica · metal, plastic · metalli, muovi ·
metal, plastik

Tischleuchte · Table lamp
↑ 30 cm, Ø 13,1 cm, ↗ 22 cm
excl. 1 x E27, max. 18 W



5027011-01
5027011-17
5027011-47



01 | Weiß · white 17 | mehrfarbig · multicolor 47 | silberfarbig · silver-coloured



TAJO

Metall · metal ·
metale · metaal · metal ·
metallo · metal · metalli · metal

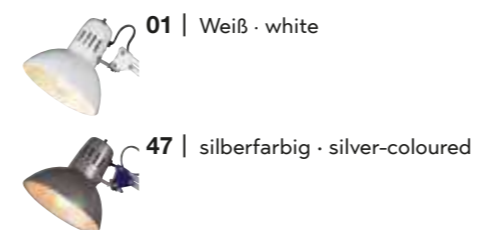

01 | Weiß · white
47 | silberfarbig · silver-coloured



Tischleuchte · Table lamp
↑ 73,5 cm, Ø 16,8 cm, ↗ 51 cm
excl. 1 x E27, max. 40 W



5029010-01
5029010-47



Spotserien

Spots
Spotterie
Spots
Focos
Faretti
Spoturi
Spotit
Reflektorki



geeignet für Auf- und Einbau · suitable for both mounting and installation · adapté au montage et à l'installation · geschikt voor in en opbouw · apropiadas tanto para montaje como para instalación · ideale sia per montaggio e installazione · adecvate pentru aplicare și încorporare · sopii pinta- ja uppoasennukseen · odpowiednie zarówno do montażu jak i instalacji



TAURUS

Metall, Weiß matt oder Schwarz matt · metal, white mat or black mat · metale, blanc mat ou noir mat · metaal, wit mat of mat zwart · metal, estera blanca o estera negra · metallo, bianco opaco o nero opaco · metal, alb mat sau negru mat · metalli, valkoinen matto tai musta matto · metal, biały mat lub czarny mat

Getrennt schaltbar · Separately switchable

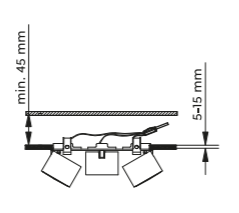
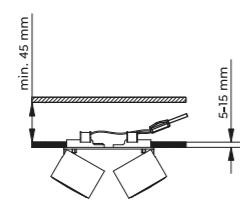
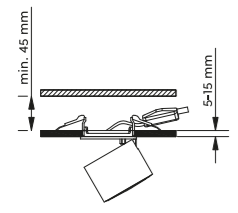

Strahler · Spot
 Ø 8,7 cm, ↑ 10,6 cm
 incl. SMD-LED, 5 W
 450 lm, 3.000 K
 incl. SMD-LED, 1,5 W
 110 lm, 3.000 K

Strahler · Spot
 ↔ 18 x 8,7 cm, ↑ 10,6 cm
 incl. 2 x SMD-LED, 5 W
 2 x 450 lm, 3.000 K
 incl. 2 x SMD-LED, 1,5 W
 2 x 110 lm, 3.000 K

Strahler · Spot
 ↔ 27,3 x 8,7 cm, ↑ 10,6 cm
 incl. 3 x SMD-LED, 5 W
 3 x 450 lm, 3.000 K
 incl. 3 x SMD-LED, 1,5 W
 3 x 110 lm, 3.000 K



652910131
652910132



652910231
652910232



652910331
652910332



31 | Weiß matt · white mat

32 | Schwarz matt · black mat

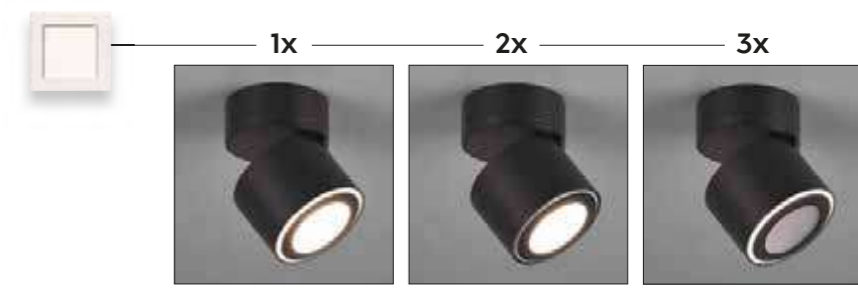





geeignet für Auf- und Einbau · suitable for both mounting and installation ·
 adapté au montage et à l'installation · geschikt voor in en opbouw ·
 apropiadas tanto para montaje como para instalación · ideale sia per montaggio e installazione ·
 adecvate pentru aplicare și încorporare · sopii pinta- ja uppoasennukseen ·
 odpowiednie zarówno do montażu jak i instalacji





Empfohlen:
 recommended: LED GU10, 5 W
 400 lm, 3.000 K
 956-5936

GUAYANA

Metall · metal ·
 metale · metaal · metal ·
 metallo · metal · metalli · metal

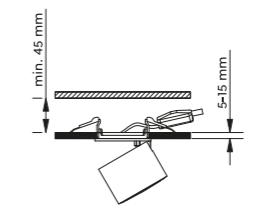
-  07 | Nickel matt · nickel mat
-  31 | Weiß matt · white mat
-  32 | Schwarz matt · black mat

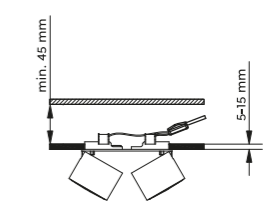

Strahler · Spot
 Ø 8,7 cm, ↑ 12 cm
 excl. 1 x GU10, max. 35 W

 651000107
 651000131
 651000132

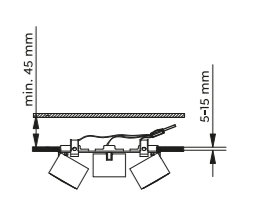

Strahler · Spot
 ↔ 18 x 8,7 cm, ↑ 12 cm
 excl. 2 x GU10, max. 35 W

 651000207
 651000231
 651000232



Strahler · Spot
 ↔ 27,3 x 8,7 cm, ↑ 12 cm
 excl. 3 x GU10, max. 35 W

 651000307
 651000331
 651000332



CLAPTON

Aluminium gebürstet, Chrom, Glas Weiß gewischt · brushed aluminium, chrome, glass white brushed glass · aluminium balayé, chrome, verre blanc balayé · geborsteld aluminium, chrom, wit geborsteld glas · aluminio pulido, cromo, blanco pulido · alluminio spazzolato, cromo, vetro bianco spazzolato · aluminiu lucios, crom, alb lucios · harjattu alumiini, kromi, lasi harjattu valkoinen · aluminium szczotkowane, chrom, szkło białe otarła



Strahler · Spot
↔ 36 x 7 cm, ↑ 18,5 cm
incl. 2 x SMD-LED, 4,3 W
2 x 430 lm, 3.000 K



821470205

Strahler · Spot
↔ 50 x 7 cm, ↑ 18,5 cm
incl. 3 x SMD-LED, 4,3 W
3 x 430 lm, 3.000 K



821410305

Strahler · Spot
↔ 96,5 x 8 cm, ↑ 18,5 cm
incl. 4 x SMD-LED, 4,3 W
4 x 430 lm, 3.000 K



821410405

Strahler · Spot
↔ max.150 x 8 cm, ↑ 24 cm
incl. 6 x SMD-LED, 4,3 W
6 x 430 lm, 3.000 K



821410605

Strahler · Spot
↑ 20 x 7 cm, ↗ 16 cm
incl. 1 x SMD-LED, 4,3 W
430 lm, 3.000 K



821470105

Strahler · Spot
↔ 31 x 22 cm, ↑ 18,5 cm
incl. 4 x SMD-LED, 4,3 W
4 x 430 lm, 3.000 K



821430405

Strahler · Spot
↔ 70 x 50 cm, ↑ 23 cm
incl. 5 x SMD-LED, 4,3 W
5 x 430 lm, 3.000 K



621410505



Strahler · Spot
 ↑ 12 x 7,5 cm, ↗ 16 cm
 incl. SMD-LED, 6,5 W
 650 lm, 3.000 K



873170107
 873170131



Strahler · Spotp
 ↔ 28,5 x 9,5 cm, ↗ 16 cm
 incl. 2 x SMD-LED, 6,5 W
 2 x 650 lm, 3.000 K



873170207
 873170231



Strahler · Spot
 ↔ 45 x 7,5 cm, ↑ 16 cm
 incl. 3 x SMD-LED, 6,5 W
 3 x 650 lm, 3.000 K



873110307
 873110331



Strahler · Spot
 ↔ 81,5 x 8 cm, ↑ 20 cm
 incl. 4 x SMD-LED, 6,5 W
 4 x 650 lm, 3.000 K



873110407
 873110431



NARCOS

Nickel matt oder weiß · nickel mat or white ·
 nickel mat ou blanc · nikkell mat of wit · níquel mate o blanco · nichel opaco o bianco ·
 nichel mat sau alb · harjattu teräs tai valkoinen · nikiel mat lub biały



07 | Nickel matt · nickel mat



31 | Weiß matt · white mat

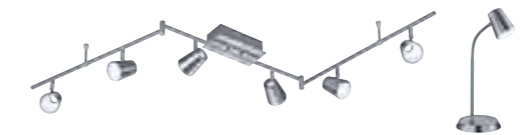

Strahler · Spot
 ↔ 177 x 10 cm, ↑ 23 cm
 incl. 6 x SMD-LED, 6,5 W
 6 x 650 lm, 3.000 K



873110607
 873110631



Tischleuchte · Table lamp
 ↓ 38 cm, ↗ 23 cm
 incl. SMD-LED, 6,9 W
 650 lm, 3.000 K



573190107
 573190131



Stehleuchte · Floor lamp
 ↓ 154 cm, ↔ 28 cm
 incl. 3 x SMD-LED, 4,7 W
 3 x 470 lm, 3.000 K



473190307
 473190331

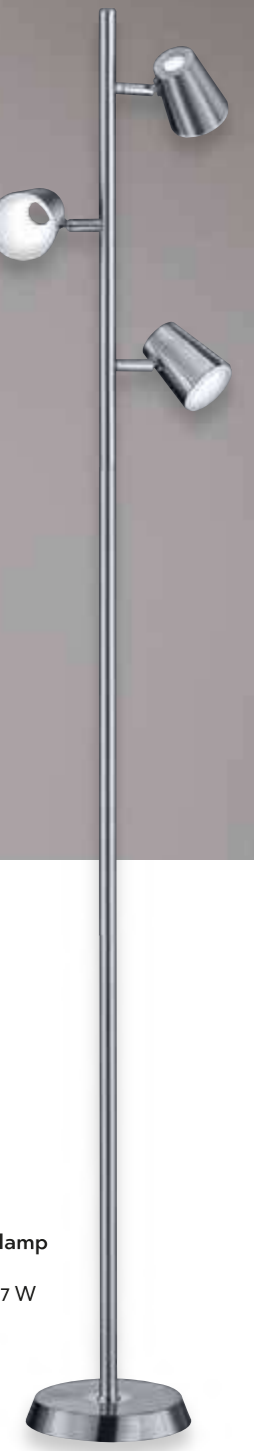

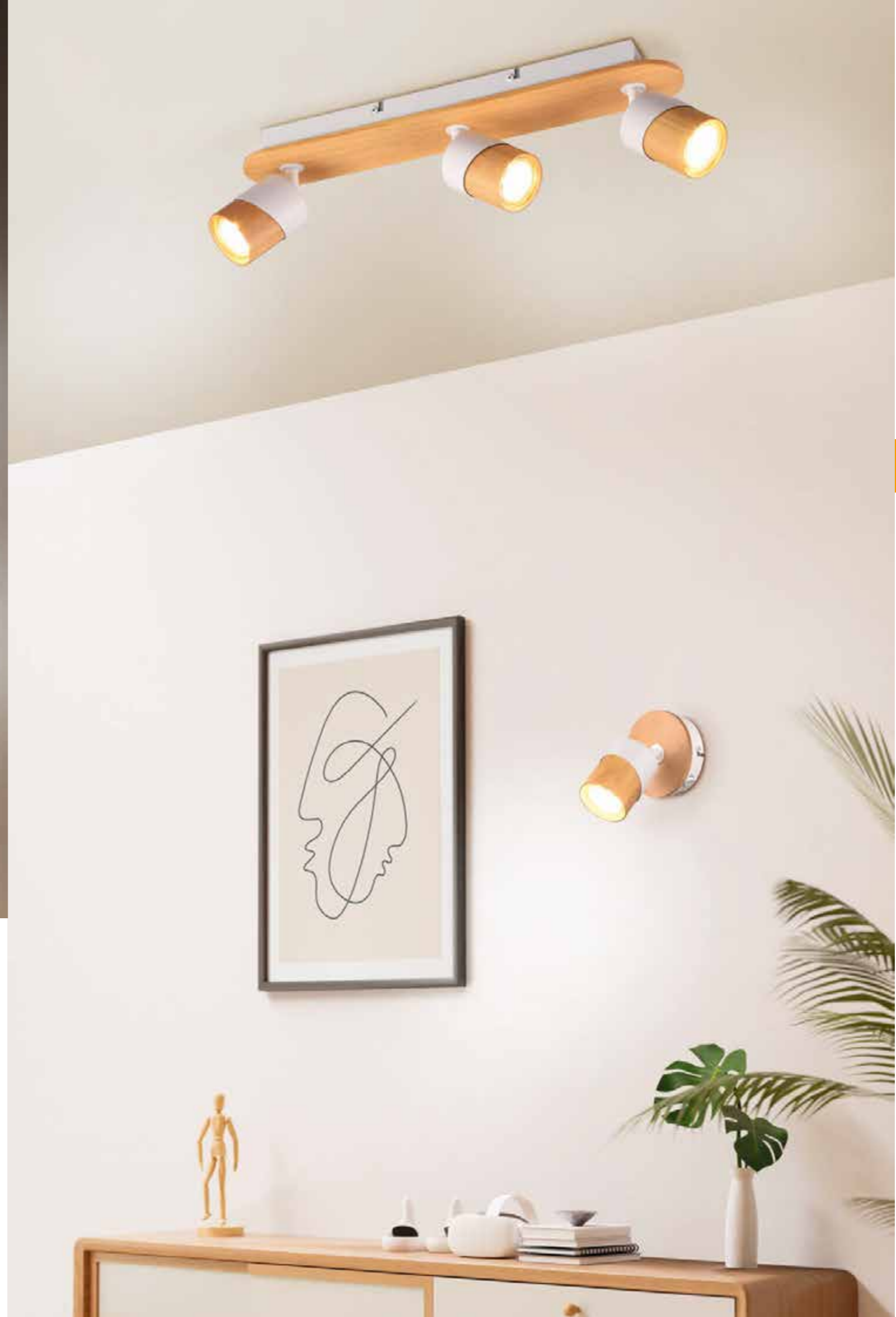

ARUNI

Metall, Weiß matt oder Schwarz matt, Holz naturbelassen · metal, white mat or black mat, wood natural finish ·
 métal, blanc mat ou noir mat, bois finition naturelle · metaal, wit mat mat zwart, hout natuurlijke afwerking · metal, estera blanca o estera negra,
 madera acabado natural · metallo, bianco opaco o nero opaco, di legno finitura naturale · metal, alb mat sau negru mat, lemn finisaj natural ·
 metalli, mattavalkoinen tai mattamusta, puu luonnollinen viimeistely · metal, biały mat lub czarny mat, drewno naturalne wykończenie



Strahler · Spot
 ↑ 13,5 x 11 cm, ↗ 15 cm
 excl. 1 x GU10, max. 35 W



801170131
 801170132



Strahler · Spot
 ↔ 28 x 9 cm, ↗ 15 cm
 excl. 2 x GU10, max. 35 W



801100231
 801100232



Strahler · Spot
 ↔ 48 x 9 cm, ↗ 15 cm
 excl. 3 x GU10, max. 35 W



801100331
 801100332

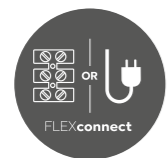
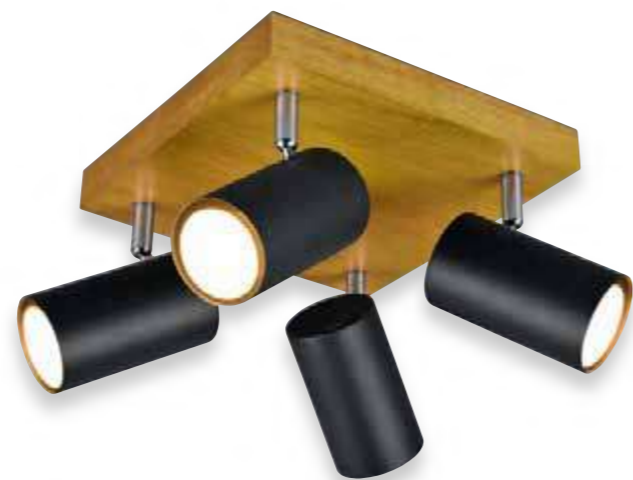
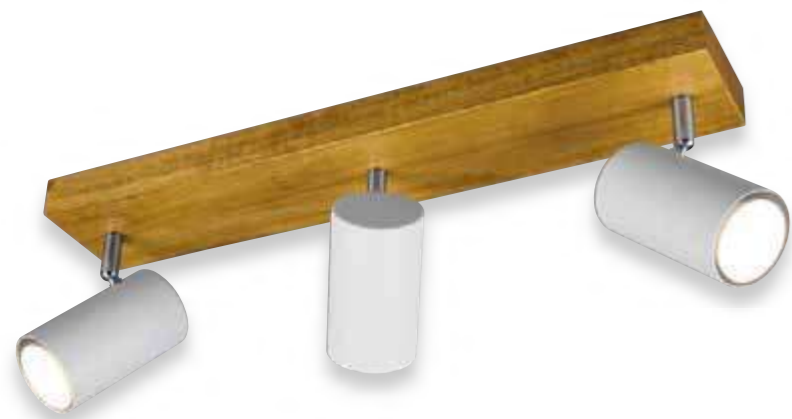

Seite/page 580

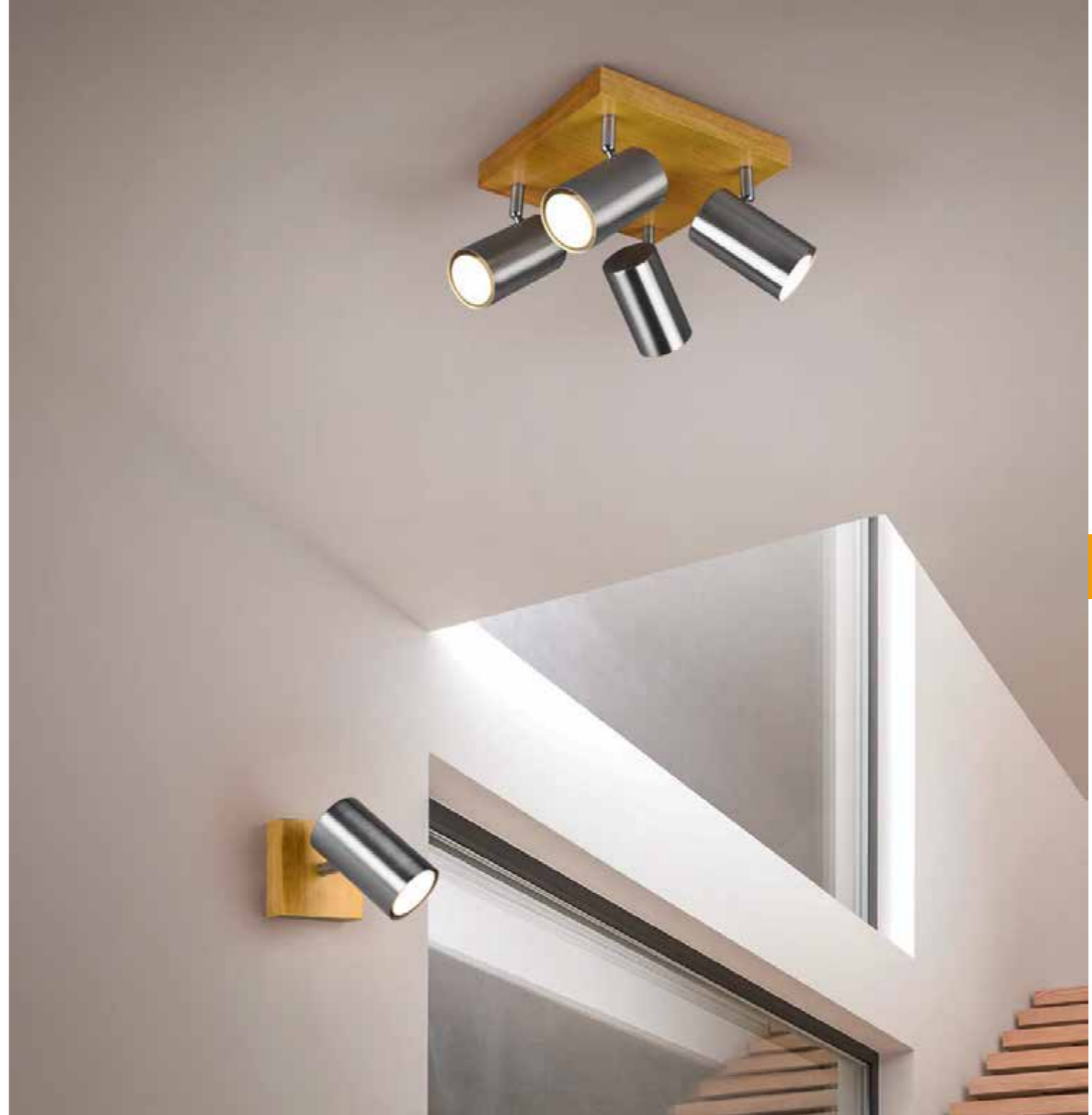

MARLEY

Metall, Holz · metal, wood ·
metale, bois · metaal, hout · metal, madera ·
metallo, di legno · metal, lemn · metalli, puu · metal, drewno



Wandleuchte · Wall lamp
↔ 12 x 9 cm, ↗ 16 cm
excl. 1 x GU10, max. 15 W

Deckenleuchte · Ceiling lamp
↔ 26 x 9 cm, ↓ 16 cm
excl. 2 x GU10, max. 35 W

Deckenleuchte · Ceiling lamp
↔ 44 x 9 cm, ↓ 16 cm
excl. 3 x GU10, max. 35 W

Deckenleuchte · Ceiling lamp
↔ 22 x 22 cm, ↓ 16 cm
excl. 4 x GU10, max. 35 W



812400107
812400131
812400132



812400207
812400231
812400232



812400307
812400331
812400332



812400407
812400431
812400432

Empfohlen:
recommended: LED GU10, 4,5 W
345 lm, 3.000 K



956-55



07 | Nickel matt · nickel mat



31 | Weiß matt · white mat



32 | Schwarz matt · black mat



Empfohlen:
recommended: LED GU10, 4,5 W
345 lm, 3.000 K



956-55

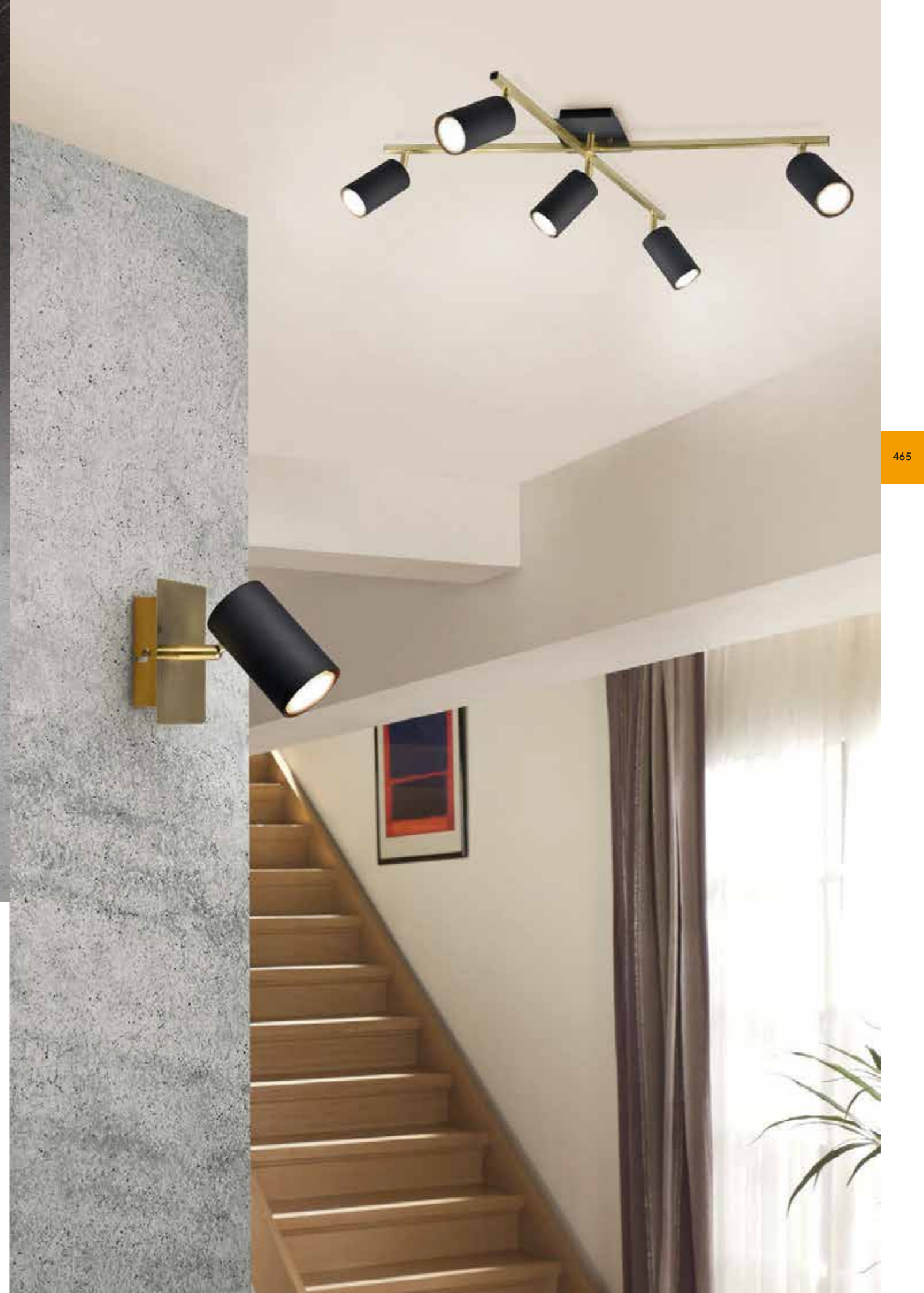

MARLEY

Metall, Schwarz-Gold · metal, black-gold ·
métal, noir et or · metaal, zwart-goud · metal, negro-oro ·
metallo, oro nero · metal, negru-auriu · metalli, musta-kulta · metal, czarno złoty



Strahler · Spot
↓ 12 x 12 cm, ↗ 15 cm
excl. 1 x GU10, max. 25 W



802400180



Strahler · Spot
↔ 30 x 9 cm, ↓ 15 cm
excl. 2 x GU10, max. 35 W



802400280



Strahler · Spot
↔ 48 x 9 cm, ↓ 15 cm
excl. 3 x GU10, max. 35 W



802400380



Strahler · Spot
↔ 24 x 24 cm, ↓ 15 cm
excl. 4 x GU10, max. 35 W



802430480



Strahler · Spot
↔ 77,4 x 57,4 cm, ↓ 22,4 cm
excl. 5 x GU10, max. 35 W



612400580



Empfohlen:
recommended: LED GU10, 4,5 W
345 lm, 3.000 K



956-55



Strahler · Spot
↑ 12 x 12 cm, ↗ 15 cm
excl. 1 x GU10, max. 25 W



- 802400101
- 802400104
- 802400107
- 802400124
- 802400132

Strahler · Spot
↔ 30 x 9 cm, ↑ 15 cm
excl. 2 x GU10, max. 35 W



- 802400201
- 802400204
- 802400207
- 802400224
- 802400232

Strahler · Spot
↔ 48 x 9 cm, ↑ 15 cm
excl. 3 x GU10, max. 35 W



- 802400301
- 802400304
- 802400307
- 802400324
- 802400332

Strahler · Spot
↔ 77,4 x 57,4 cm, ↑ 22,4 cm
excl. 5 x GU10, max. 35 W



- 612400501
- 612400504
- 612400507
- 612400532

MARLEY

Metall · metal ·
metale · metaal · metal · metallo · metal · metalli · metal



01 | Weiß · white



04 | Altmessing · old brass



07 | Nickel matt · nickel mat



24 | rostfarbig · rusty



32 | Schwarz matt · black mat



Wandleuchte · Wall lamp
↑ 18 x 6 cm, ↗ 8 cm
excl. 2 x GU10, max. 35 W



- 212400201
- 212400204
- 212400207
- 212400224
- 212400232



Strahler · Spot
↔ 24 x 24 cm, ↑ 15 cm
excl. 4 x GU10, max. 35 W



- 802430401
- 802430404
- 802430407
- 802430424
- 802430432



Empfohlen:
recommended: LED GU10, 4,5 W
345 lm, 3.000 K



956-55



LEON

Metall, schwarz matt · metal, black mat ·
metale, noir mat · metaal, mat zwart · metal, estera negra · metallo, nero opaco ·
metal, negru mat · metalli, mattamusta · metal, czarny mat



Strahler · Spot
↔ 11 x 16 cm, √ 19 cm
excl. 1 x GU10, max. 35 W



800700132



Strahler · Spot
↔ 28 x 16 cm, √ 19 cm
excl. 2 x GU10, max. 35 W



800700232



Strahler · Spot
↔ 44 x 16 cm, √ 19 cm
excl. 3 x GU10, max. 35 W



800700332



Strahler · Spot
↔ 60 x 16 cm, √ 19 cm
excl. 4 x GU10, max. 35 W



800700432



MICHAEL

Nickel matt · nickel mat ·
 nickel mat · nikkel mat · níquel mate · nichel opaco ·
 nichel mat · harjattu teräs · nikiel mat · mat nikel



Strahler · Spot
 ↑ 10,6 x 6 cm, ↗ 13 cm
 excl. 1 x GU10, max. 28 W



803000107



Strahler · Spot
 ↔ 32 x 5 cm, ↑ 13 cm
 excl. 2 x GU10, max. 28 W



803000207



Strahler · Spot
 ↔ 54 x 5 cm, ↑ 13 cm
 excl. 3 x GU10, max. 28 W



803000307



Strahler · Spot
 Ø 25,5 cm, ↑ 15 cm
 excl. 3 x GU10, max. 28 W



803090307



PAGO

Metall, Weiß matt oder Schwarz matt · metal, white mat or black mat ·
 metale, blanc mat ou noir mat · metaal, wit mat of mat zwart ·
 metal, estera blanca o estera negra · metallo, bianco opaco o nero opaco ·
 metal, alb mat sau negru mat · metalli, valkoinen matto tai musta matto ·
 metal, biały mat lub czarny mat



31 | Weiß matt ·
 white mat



32 | Schwarz matt ·
 black mat

Strahler · Spot
 Ø 10 cm, ↗ 15 cm
 excl. 1 x GU10, max. 35 W



803500131
 803500132



Strahler · Spot
 ↔ 24 x 7 cm, ↑ 15 cm
 excl. 2 x GU10, max. 35 W



803500231
 803500232



Strahler · Spot
 ↔ 41 x 7 cm, ↑ 15 cm
 excl. 3 x GU10, max. 35 W



803500331
 803500332



LEVISTO

Nickel matt oder Messing matt, Glas alabasterfarbig · nickel mat or brass mat, alabaster-coloured glass · nickel mat ou laiton mat, verre couleur albâtre · nikel mat of messing mat, albastkleurig glas · níquel mate o bronze mate, vidrio de color alabastro · nichel opaco o ottone satinato, vetro colore alabastro · nichel mat sau bronz mat, sticla culoare alabastru · harjattu teräs tai mattamessinki, lasi alabasteri väri · nikiel mat lub mosiądz mat, szkło alabaster kolor



Strahler · Spot
↔ 33 cm, ↓ 19 cm
incl. 2 x LED E14, 6 W
2 x 470 lm, 3.000 K

Strahler · Spot
↔ 55 cm, ↓ 19 cm
incl. 3 x LED E14, 6 W
3 x 470 lm, 3.000 K

Strahler · Spot
↔ 88 cm, ↓ 19 cm
incl. 4 x LED E14, 6 W
4 x 470 lm, 3.000 K



Strahler · Spot
↔ 180 cm, ↓ 21 cm
incl. 6 x LED E14, 6 W
6 x 470 lm, 3.000 K

871010207
871010208

871010307
871010308

871010407
871010408

871010607
871010608



incl.
LED E14, 5 W
400 lm, 3.000 K

983-60



07 | Nickel matt · nickel mat



Strahler · Spot
Ø 10 cm, ↓ 19 cm
incl. 1 x LED E14, 6 W
470 lm, 3.000 K

871010107
871010108



Strahler · Spot
Ø 30 cm, ↓ 21 cm
incl. 3 x LED E14, 6 W
3 x 470 lm, 3.000 K

871090307
871090308



08 | Messing matt · brass mat



Seite/page 580



ROXIE

Metall, weiß matt oder schwarz matt, Chrom · metal, white mat or black mat, chrome · Métal, Blanc mat ou Noir mat, Chrome · Metaal, Wit mat of Mat zwart, Chrom · Metal, Estera blanca o Estera negra, Cromo · Metallo, Bianco opaco o Nero opaco, Cromo · Metal, Alb mat sau Negru mat, Crom · Metalli, mattavalkoinen tai mattamusta, Kromi · Metal, Biały mat lub Czarny mat, Chrom

Empfohlen:
recommended: Filament LED E14, 4 W
470 lm, 2.700 K



983-400



Strahler · Spot
↓ 22,7 cm, ↔ 10 cm, ↗ 15,7 cm
excl. 1 x E14, max. 10 W



811900131
811900132



Strahler · Spot
↔ 40 x 13,8 cm, ↓ 22,8 cm
excl. 2 x E14, max. 10 W



811900231
811900232



Strahler · Spot
↔ 60 x 13,8 cm, ↓ 22,8 cm
excl. 3 x E14, max. 10 W



811900331
811900332



31 | Weiß matt · white mat



32 | Schwarz matt · black mat



Tischleuchte · Table lamp
↓ 43 cm, ↔ 17 cm, ↗ 22,5 cm
excl. 1 x E14, max. 10 W



511900131
511900132



Stehleuchte · Floor lamp
↓ 155 cm, ↔ 43 cm, ↗ 23 cm
excl. 2 x E14, max. 10 W



411900231
411900232



Seite/page 580

Empfohlen:
recommended: Filament LED E14, 4 W
470 lm, 2.700 K



983-400



STEAM

Metall, Weiß antik · metal, antique white ·
Métal, Blanc antique · Metaal, Antiek wit · Metal, Blanco decapé ·
Metallo, Bianco anticato · Metal, Alb antic · Metalli, Antiikkivalkoinen ·
Metal, Antyczny biały



Strahler · Spot
↑ 14 cm, ↔ 10 cm, ↗ 19 cm
excl. 1 x E14, max. 10 W



813400127



Strahler · Spot
↔ 30 x 10 cm, ↑ 22 cm
excl. 2 x E14, max. 25 W



813400227



Strahler · Spot
↔ 77 x 10 cm, ↑ 17,5 cm
excl. 4 x E14, max. 25 W



813400427



Strahler · Spot
Ø 28 cm, ↑ 19 cm
excl. 3 x E14, max. 25 W



813430327



2-Phasen- Schienensystem

2-phase track system
Système de voie à deux phases
2-fase-spoorsysteem
Sistema de rieles en 2 fases
Sistema a binario bifase
Sistem de piste cu 2 faze
2-vaihekiskojärjestelmä
2-fazowy system prowadnic



Für jede Raumsituation die ideale Beleuchtung.

Das DUOline 2-Phasen-Schiensystem ist äußerst flexibel und bietet zahlreiche Möglichkeiten zur individuellen Lichtgestaltung. Die verschiedenen Spots und Pendelleuchten lassen sich frei in der Schiene platzieren und können so gezielt in allen Wohnbereichen eingesetzt werden. Das 2-Phasensystem ermöglicht, dass mit nur einem Stromanschluss zwei Beleuchtungsgruppen getrennt voneinander geschaltet oder gedimmt werden können.

The ideal lighting for every room situation.

The DUOline 2-phase track system is extremely flexible and offers numerous possibilities for individual lighting arrangements. The various spotlights and pendant lamps can be positioned as desired in the track and can therefore be used in all living areas. The 2-phase system allows two lighting groups to be switched or dimmed independently of each other with just one power connection.

L'éclairage parfait pour chaque type de pièces.

Le système de rails biphasés DUOline est extrêmement flexible et offre de nombreuses possibilités de conception individuelle de l'éclairage. Les différents projecteurs et luminaires suspendus peuvent être positionnés librement dans le rail et peuvent donc être utilisés de manière spécifique dans tous vos espaces d'habitation. Le système biphasé permet de commuter ou de faire varier l'intensité de deux groupes d'éclairage séparément l'un de l'autre avec un seul branchement électrique.

Voor elke situatie de ideale verlichting.

Het DUOline-2-fase-spoorsysteem is uiterst flexibel en biedt talrijke mogelijkheden voor een individuele lichtvormgeving. De diverse spots en hanglampen kunnen willekeurig in het spoor geplaatst worden en kunnen zo doelgericht in alle woonruimtes gebruikt worden. Het 2-fase-systeem maakt mogelijk dat met slechts één stroomaansluiting twee verlichtingsgroepen apart van elkaar geschakeld of gedimd kunnen worden.

La iluminación ideal para cada habitación.

El sistema de rieles en 2 fases DUOline es extraordinariamente flexible y ofrece numerosas posibilidades de diseño lumínico individuales. Los distintos puntos y lámparas de péndulo le permiten colocar los rieles libremente y por eso pueden utilizarse en toda la vivienda. El sistema de rieles en 2 fases permite que se activen o atenúen dos grupos de lámparas separados con un solo cable de corriente.

L'illuminazione ideale per qualsiasi esigenza abitativa.

Il sistema a binario bifase DUOline è estremamente flessibile e offre numerose possibilità per la progettazione individuale dell'illuminazione. I vari faretti e lampade a sospensione possono essere posizionati liberamente nel binario e possono quindi essere utilizzati in modo specifico in tutti gli ambienti abitativi. Il sistema bifase consente di commutare o dimmerare due gruppi di illuminazione separatamente l'uno dall'altro con una sola connessione di alimentazione.

Iluminatul ideal pentru fiecare încăpere.

Sistemul de piste cu 2 faze DUOline este deosebit de flexibil și oferă numeroase posibilități pentru structurarea individuală a luminii. Diferitele spot-uri și lustre pot fi amplasate liber pe pistă și pot fi astel utilizate țintit în toate zonele spațiilor de locuit. Sistemul cu 2 faze permite comutarea și reglarea intensității pentru două grupuri de corpuri de iluminat separate, folosind un singur racord electric.

Ihanteellinen valaistus jokaiseen huoneen käyttöilanteeseen.

DUOline 2-vaihekiskojärjestelmä on erittäin joustava ja tarjoaa lukuisia vaihtoehtoja yksilölliseen valaistuksen suunnitteluun. Eri spotti- ja ripustettavat valaisimet voidaan sijoittaa mihin tahansa kiskoon, joten niitä voidaan käyttää kaikissa asuintiloissa. 2-vaihejärjestelmä mahdollistaa kahden valaistusryhmän kytkemisen tai himmentämisen erikseen yhdellä sähköliitännällä.

Idealne oświetlenie do każdej sytuacji w pomieszczeniu.

Dwufazowy system prowadnic DUOline jest niezwykle elastyczny i oferuje wiele opcji indywidualnego projektowania oświetlenia. Różne skupienia i lampy wiszące można umieścić w dowolnym miejscu na szynie, dzięki czemu można je stosować we wszystkich pomieszczeniach mieszkalnych. System 2-fazowy umożliwia osobne przełączanie lub przyciemnianie dwóch grup oświetlenia za pomocą tylko jednego podłączenia zasilania.

ÜBERSICHT KOMPONENTEN

Component overview · Aperçu des composants · Overzicht van componenten · Vista general por componentes · Panoramica dei componenti · Prezentare generală a componentelor · Komponentteihin yleiskuvas · Przegląd komponentów

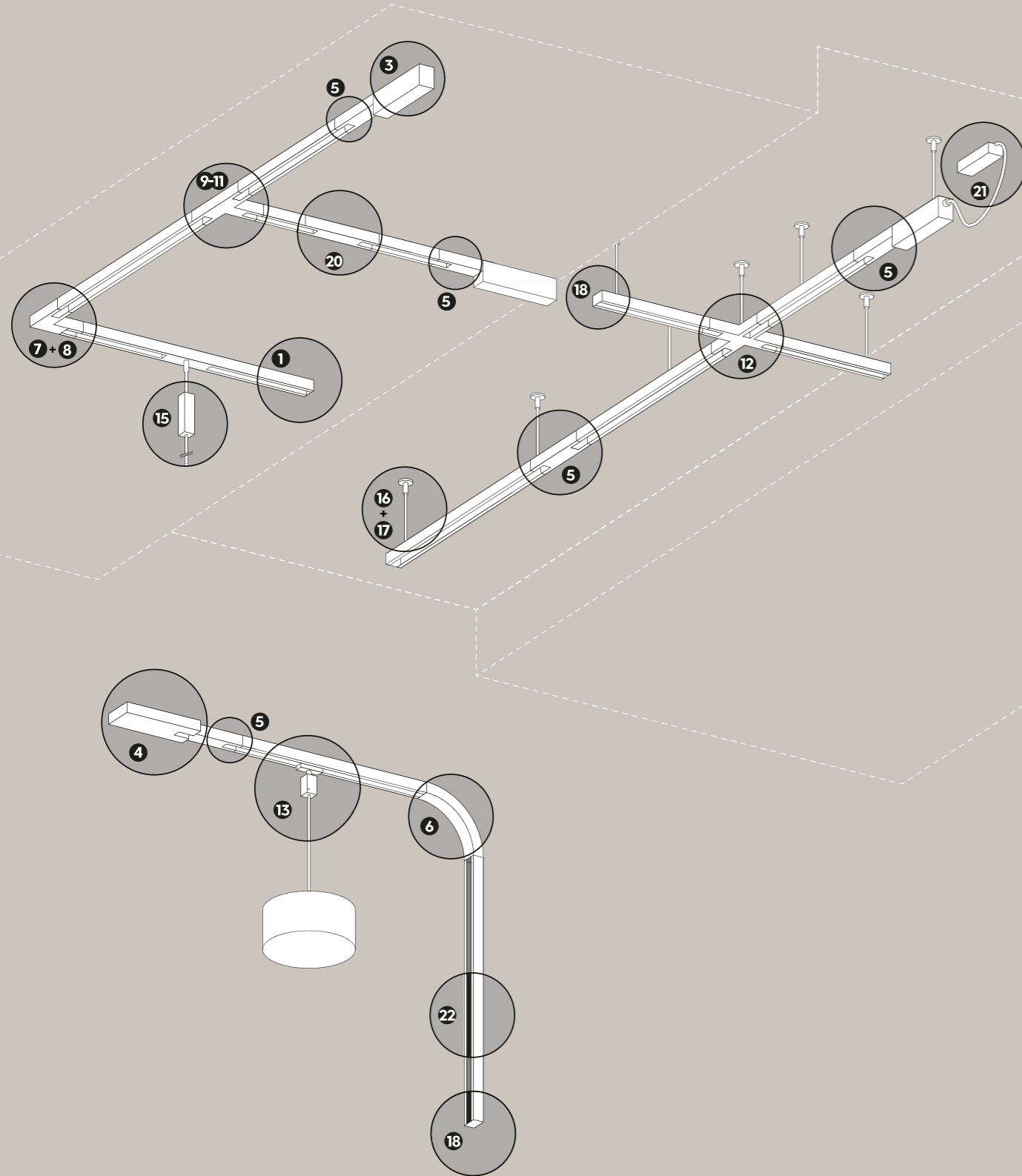

Die Vorteile von DUOLINE im Überblick:

- Individuelle Lichtgestaltung
- Nur ein Stromanschluss erforderlich
- Kein Trafo notwendig
- Leuchten frei kombinierbar und leicht versetzbar
- Zwei verschiedene Lichtszenarien
- Getrenntes Schalten und Dimmen
- Für Decken- und Wandmontage geeignet

Advantages of DUOLINE at a glance:

- individual lighting arrangements
- only one power connection required
- no need for a transformer
- lamps can be freely combined and are easily positioned
- two different lighting scenarios
- separate switching and dimming
- suitable for ceilings and walls

Les avantages de DUOLINE en un coup d'œil :

- Conception individuelle de l'éclairage
- Une seule connexion électrique requise
- Pas besoin de transformateur
- Les luminaires peuvent être librement combinés et facilement déplacés
- Deux scénarios lumineux différents
- Commutation et variateur de lumière séparés
- Convient pour le montage au plafond et au mur

Overzicht van de voordelen van DUOLINE:

- Individuele lichtvormgeving
- Slechts één stroomaansluiting nodig
- Geen transformator nodig
- Lampen willekeurig combineerbaar en gemakkelijk verplaatsbaar
- Twee verschillende lichtscenario's
- Apart schakelen en dimmen
- Geschikt voor plafond- en muurmontage

Las ventajas de DUOLINE en resumen:

- Diseño lumínico individual
- Solo un cable de corriente necesario
- Ningún transformador necesario
- Lámpara combinables libremente y fácilmente desplazable
- Dos escenarios lumínicos diferentes
- Activación y atenuación separadas
- Adecuado para su montaje en techo y pared

I vantaggi di DUOLINE in sintesi:

- Progettazione individuale dell'illuminazione
- È necessario un solo collegamento di alimentazione
- Non è necessario alcun trasformatore
- Le lampade possono essere liberamente combinate e facilmente spostate
- Due differenti scenari di illuminazione
- Commutazione e dimmerazione separate
- Adatto per il montaggio a soffitto e a parete

Avantajele DUOLINE dintr-o privire:

- Structurarea individualizată a luminii
- Este necesară o singură conexiune electrică
- Nu este necesar un transformator
- Lămpile pot fi combinate liber și pot fi deplasate cu ușurință
- Două scenarii de iluminat diferite
- Comutare și reglare a intensității separate
- Adecvat pentru montajul pe plafon și pe perete

DUOLINEN EDUT LYHYESTI:

- Yksilöllinen valaistussuunnittelu
- Vaaditaan vain yksi sähköliitäntä
- Muuntajaa ei tarvita
- Valaisimia voidaan yhdistellä vapaasti ja siirtää helposti
- Kaksi erilaista valaistusskenaariota
- Erillinen kytkentä ja himmennys
- Sopii katto- ja seinäasennukseen

Zalety DUOLINE w skrócie:

- Indywidualny projekt oświetlenia
- Wymagane jest tylko jedno połączenie zasilania
- Nie wymaga transformatora
- Oprawy można dowolnie łączyć i łatwo przemieszczać
- Dwa różne scenariusze oświetlenia
- Oddzielne włączanie i ściemnianie
- Nadaje się do montażu sufitowego i ściennego

SCHIENE · TRACK



31



32



87

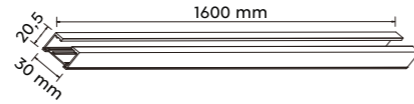
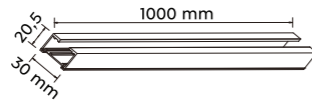
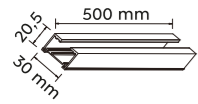

1 SCHIENE 50 CM · TRACKING 50 CM

Metall · metal

700131 | Weiß matt · white mat
700132 | Schwarz matt · black mat
700187 | titanfarbig · titan

SCHIENE 100 CM · TRACKING 100 CM

Metall · metal

700231 | Weiß matt · white mat
700232 | Schwarz matt · black mat
700287 | titanfarbig · titan

SCHIENE 160 CM · TRACKING 160 CM

Metall · metal

700331 | Weiß matt · white mat
700332 | Schwarz matt · black mat
700387 | titanfarbig · titan

Die maximale Montagelänge beträgt 30 Meter pro Einspeisung, bei einer Gesamtleistung von max. 600 Watt pro Phase.
The maximum installation length is 30 metres per power feed, with a total capacity of max. 600 watts per phase.

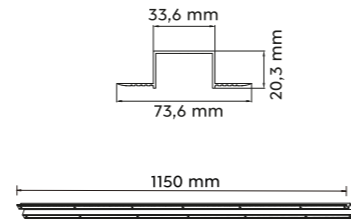

2 EINBAUPROFIL 115 CM · RECESSED PROFILE 115 CM

Metall · metal

703809 | aluminiumfarbig · aluminium

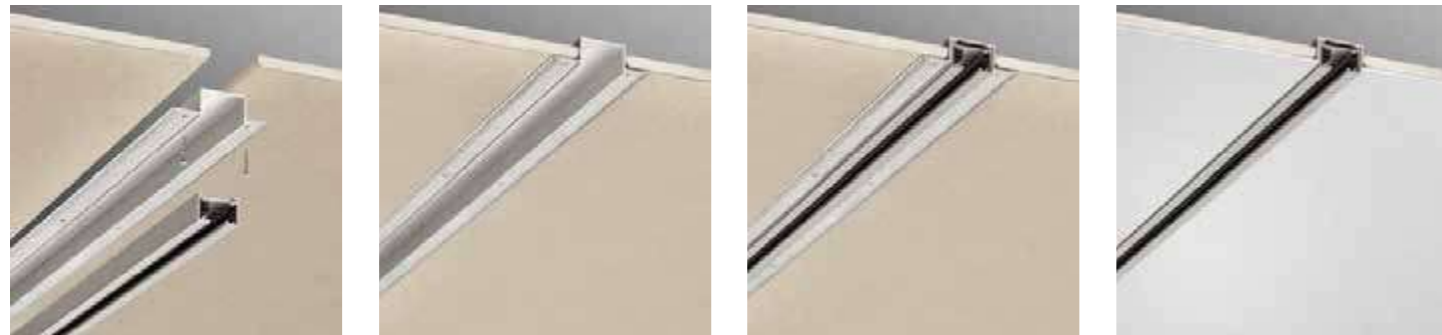

Mit diesem Einbauprofil als Zubehör können die Stromschienen anstelle der Aufputz-Montage bündig in der Decke montiert werden.
With this recessed profile as an accessory, the power tracks can be mounted flush in the ceiling instead of surface mounting.



EINSPEISUNG · POWER SUPPLY

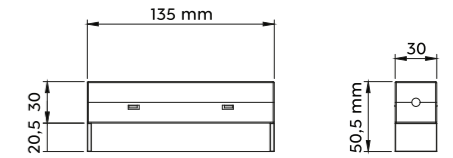

3 MITTEL-/END-EINSPEISUNG · MIDDLE-/ENDPOINT POWER SUPPLY

Kunststoff · plastic
max. 2 x 600 W

701031 | Weiß matt · white mat
701032 | Schwarz matt · black mat
701087 | titanfarbig · titan

Die Mittel-/Endeinspeisung wird direkt über dem Stromauslass angebracht und ermöglicht, Schienen auf einer Seite oder auf beiden Seiten anzuschließen.
Zur Stromversorgung der Schienen wird immer ein Verbinder benötigt.

The middle/end feed is mounted directly over the power outlet and enables tracks to be connected on one or both sides.
A connector is always required to power the rails.

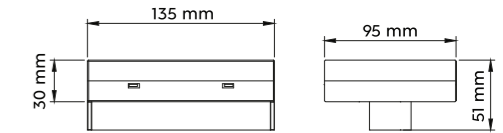

4 MITTEL-/END-EINSPEISUNG MIT ELEKTRONISCHEM PHASENWECHSLER · MIDDLE-/ENDPOINT POWER SUPPLY WITH ELECTRONIC PHASE CHANGER

Kunststoff · plastic
max. 2 x 200 W

701131 | Weiß matt · white mat
701132 | Schwarz matt · black mat
701187 | titanfarbig · titan

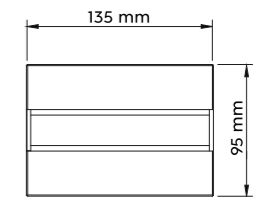

Mittels elektronischem Phasenwechsler lassen sich die zwei Phasen auch bei dreidrähtigen Stromleitungen getrennt Schalten und Dimmen.
Zur Stromversorgung der Schienen wird immer ein Verbinder benötigt.

Using an electronic phase changer, the two phases can be switched and dimmed separately, even with three-core power cables.
A connector is always required to power the rails.

VERBINDER · CONNECTOR

5 LÄNGSVERBINDER · LINE CONNECTOR

Kunststoff · plastic
max. 2 x 600 W

702131 | Weiß matt · white mat
702132 | Schwarz matt · black mat
702187 | titanfarbig · titan

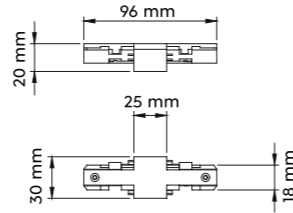

Verbindet zwei Schienen für gerade Strecken miteinander.
Connects two rails together for straight sections.

6 FLEX-VERBINDER · FLEX CONNECTOR

Kunststoff · plastic
max. 2 x 600 W

702031 | Weiß matt · white mat
702032 | Schwarz matt · black mat
702087 | titanfarbig · titan

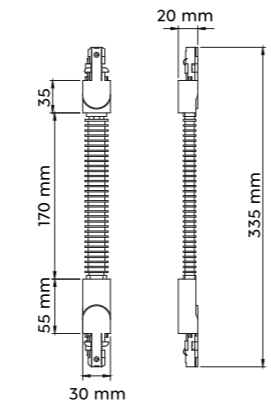

Verbindet zwei Schienen in einem beliebigen Winkel miteinander und ermöglicht die Verbindung zwischen Decken- und Wandmontage.
Connects two rails together at any angle and makes possible a connection between ceiling and wall mounting.

7 L-VERBINDER - SCHUTZLEITER INNEN · L-CONNECTOR - INNER PROTECTIVE CONDUCTOR

Kunststoff · plastic
max. 2 x 600 W

702231 | Weiß matt · white mat
702232 | Schwarz matt · black mat
702287 | titanfarbig · titan

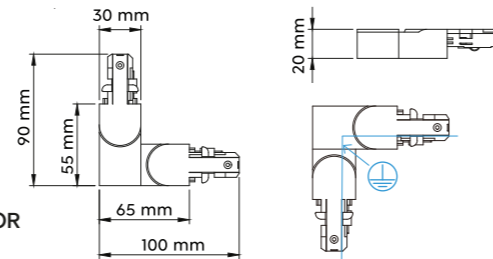

8 L-VERBINDER (TYP A) - SCHUTZLEITER AUSSEN · L-CONNECTOR (TYPE A) - OUTER PROTECTIVE CONDUCTOR

Kunststoff · plastic
max. 2 x 600 W

702231A | Weiß matt · white mat
702232A | Schwarz matt · black mat
702287A | titanfarbig · titan

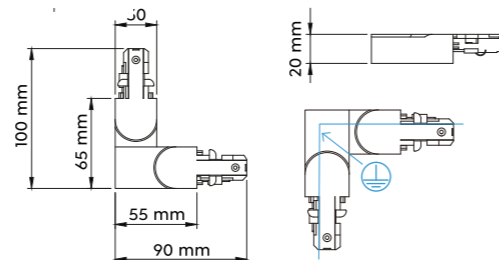

Verbindet zwei Schienen im rechten Winkel miteinander.
Connects two rails together at right angles.

9 T-VERBINDER - SCHUTZLEITER RECHTS · T-CONNECTOR - RIGHT PROTECTIVE CONDUCTOR

Kunststoff · plastic
max. 2 x 600 W

702331 | Weiß matt · white mat
702332 | Schwarz matt · black mat
702387 | titanfarbig · titan

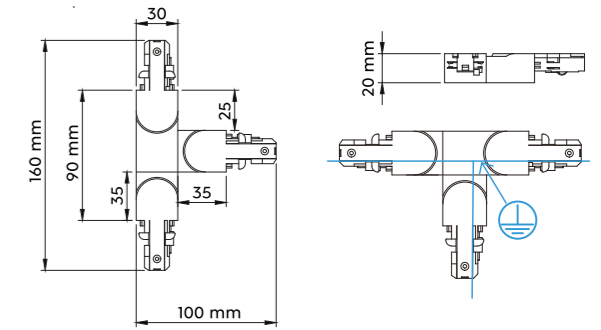

10 T-VERBINDER (TYP A) - SCHUTZLEITER LINKS · T-CONNECTOR (TYPE A) - LEFT PROTECTIVE CONDUCTOR

Kunststoff · plastic
max. 2 x 600 W

702331A | Weiß matt · white mat
702332A | Schwarz matt · black mat
702387A | titanfarbig · titan

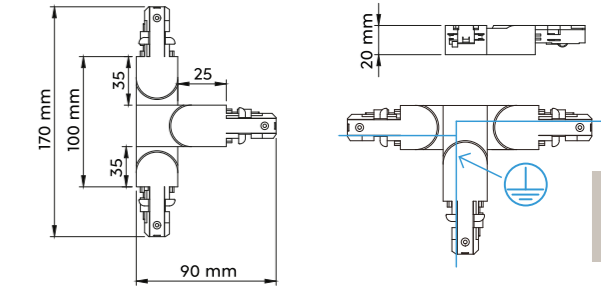

11 T-VERBINDER (TYP B) - SCHUTZLEITER LINKS · T-CONNECTOR (TYPE B) - LEFT PROTECTIVE CONDUCTOR

Kunststoff · plastic
max. 2 x 600 W

702331B | Weiß matt · white mat
702332B | Schwarz matt · black mat
702387B | titanfarbig · titan

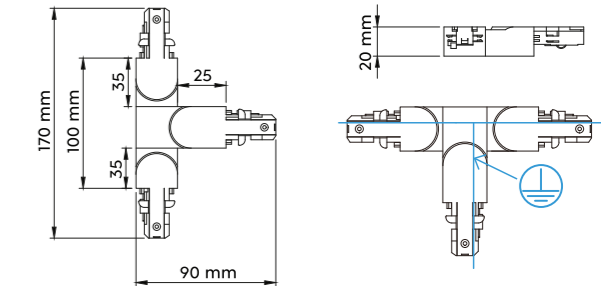

Verbindet drei Schienen im rechten Winkel miteinander.
Connects three rails together at right angles.

12 X-VERBINDER · X-CONNECTOR

Kunststoff · plastic
max. 2 x 600 W

702431 | Weiß matt · white mat
702432 | Schwarz matt · black mat
702487 | titanfarbig · titan

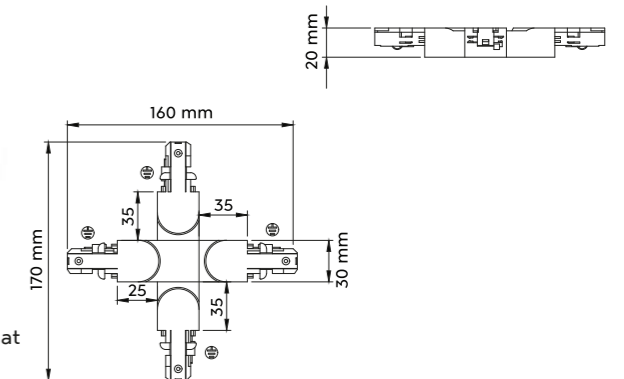

Verbindet vier Schienen im rechten Winkel miteinander.
Connects four tracks together at right angles to each other.

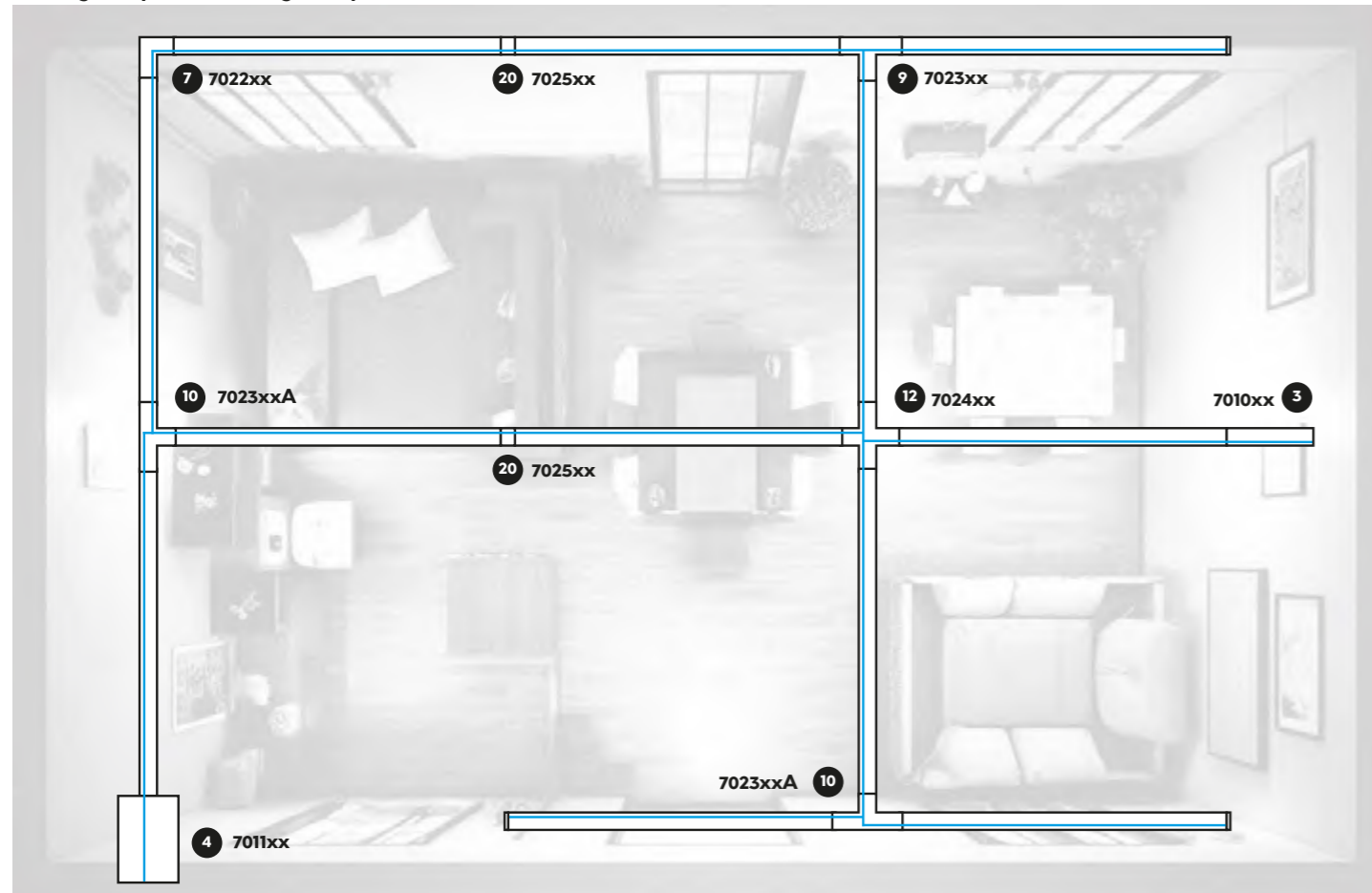
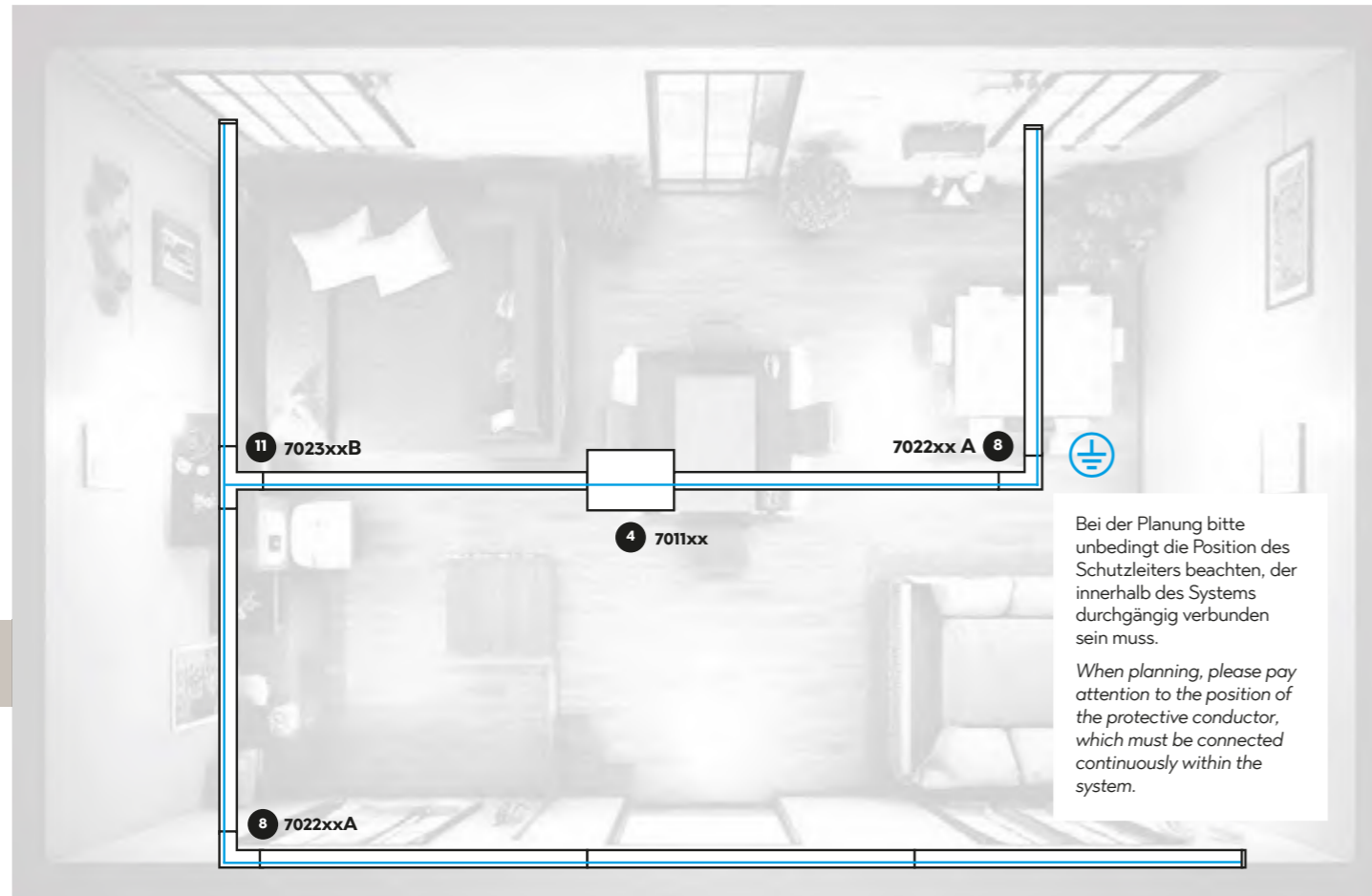

Die Komponenten sind so eingezeichnet, wie sie an der Decke/Wand montiert werden sollen. Draufsicht · Top view
Ansicht der Komponenten von oben auf der Montageseite.
 The components are drawn in as they are to be mounted on the ceiling/wall.
View of the components from above on the mounting side.

ZUBEHÖR · ACCESSORIES

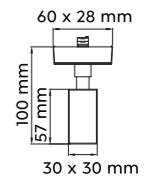

13 PENDEL-ADAPTER · PENDULAR ADAPTER

Kunststoff · plastic
 max. 60 W

703631 | Weiß matt · white mat
 703632 | Schwarz matt · black mat
 703687 | titanfarbig · titan

Dieser Pendel-Adapter ermöglicht es, herkömmliche Pendelleuchten in das DUOline Schienensystem zu integrieren.
 This pendular adapter makes it possible for conventional pendular lamps to be integrated into the DUOline track system.

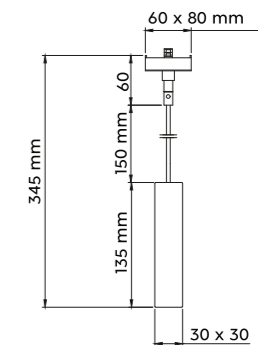
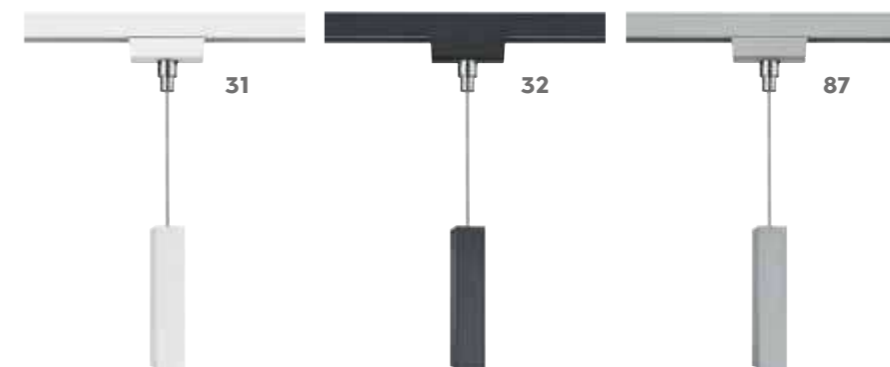

14 PENDEL-ADAPTER · PENDULAR ADAPTER

Kunststoff · plastic
 max. 60 W

703531 | Weiß matt · white mat
 703532 | Schwarz matt · black mat
 703587 | titanfarbig · titan

Dieser Pendel-Adapter ermöglicht es, herkömmliche Pendelleuchten in das DUOline Schienensystem zu integrieren.
 This pendular adapter makes it possible for conventional pendular lamps to be integrated into the DUOline track system.

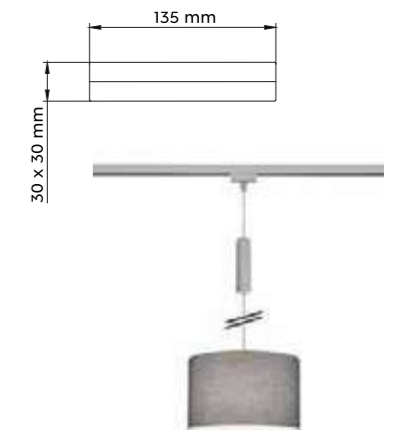

15 KABELKÜRZER · CABLE SHORTENER

Kunststoff · plastic

703331 | Weiß matt · white mat
 703332 | Schwarz matt · black mat
 703387 | titanfarbig · titan

Ermöglicht das Kürzen der Kabel von Pendelleuchten.
 Makes a shortening of the pendal lamp cable possible.



16 DISTANZHALTER SET · SUSPENSION SET

Kunststoff · plastic

703131 | Weiß matt · white mat
 703132 | Schwarz matt · black mat
 703187 | titanfarbig · titan

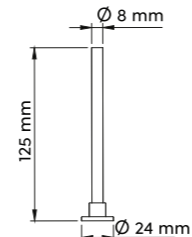

20 ISOLATOR · ISOLATOR

Kunststoff · plastic
 max. 2 x 600 W

702531 | Weiß matt · white mat
 702532 | Schwarz matt · black mat
 702587 | titanfarbig · titan

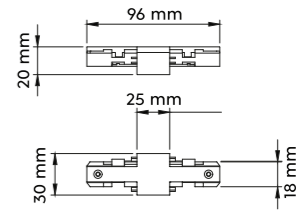

Mittels Isolator können zwei separate Schaltkreise optisch zu einem System verbunden werden.
 Using an isolator, two separate circuits can be optically connected to form one system.



17 DISTANZHALTER SET · SUSPENSION SET

Kunststoff · plastic

703231 | Weiß matt · white mat
 703232 | Schwarz matt · black mat
 703287 | titanfarbig · titan

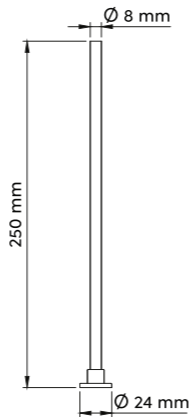

21 FLEXIBLE STROMVERSORGUNG · FLEX POWER SUPPLY

Kunststoff · plastic
 max. 2 x 600 W

701231 | Weiß matt · white mat
 701232 | Schwarz matt · black mat
 701287 | titanfarbig · titan

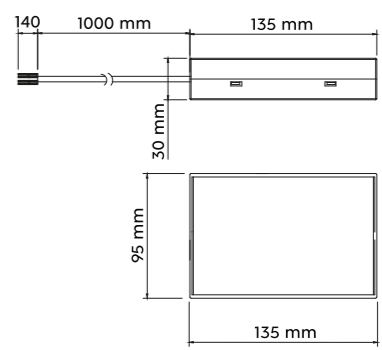

Die flexible Stromversorgung wird benötigt, wenn die Schienen nicht direkt über den Stromauslass verlegt werden können.
Nur in Verbindung mit einer Mittel-/Endeinspeisung.
 The flexible power supply is required if the rails cannot be mounted directly over the power outlet.
Only in use with a middle-/endpoint power supply.



18 ENDKAPPEN · END CAPS

Kunststoff · plastic

703031 | Weiß matt · white mat
 703032 | Schwarz matt · black mat
 703087 | titanfarbig · titan

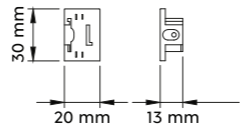

19 AUSTAUSCHCOVER FÜR ADAPTER · EXCHANGE COVER FOR ADAPTER

Kunststoff · plastic

703731 | Weiß matt · white mat
 703732 | Schwarz matt · black mat
 703787 | titanfarbig · titan

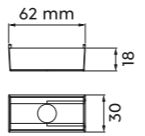

22 ABDECKSCHIENE · SAFETY COVER STRIP

Kunststoff · plastic
 ↔ 100 x 1,4 cm, ∠ 0,5 cm

703952 | Transparent · transparent



23 ABDECKPLATTE · COVER PLATE

Metall · metal
 ↓ 0,1 cm, Ø 1 cm

703431 | Weiß matt · white mat



RADIATOR

Metall · metal · metale · metaal · metal · metallo · metal · metalli · metal



STRAHLER · SPOT
incl. SMD-LED, 15 W
1.270 lm, 2.300 + 3.000 + 4.000 K



78030131 | Weiß matt · white mat
78030132 | Schwarz matt · black mat
78030187 | titanfarbig · titan

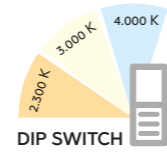
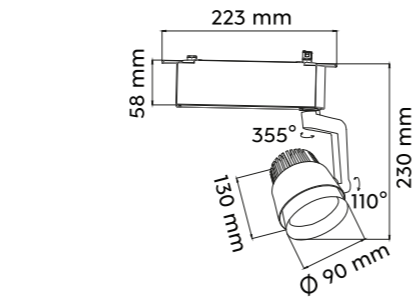

LEON

Metall · metal · metale · metaal · metal · metallo · metal · metalli · metal



STRAHLER · SPOT
excl. 1 x GU10, max. 25 W



78070107 | Nickel matt · nickel mat
78070131 | Weiß matt · white mat
78070132 | Schwarz matt · black mat

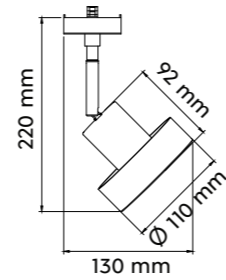

Empfohlen:
recommended: LED GU10, 5 W
400 lm, 3.000 K



956-5936

ROUBAIX

Metall · metal · metale · metaal · metal · metallo · metal · metalli · metal



STRAHLER · SPOT
incl. SMD-LED, 4 W
400 lm, 3.000 K



78150107 | Nickel matt · nickel mat
78150131 | Weiß matt · white mat
78150132 | Schwarz matt · black mat

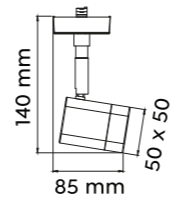



MARLEY

Metall · metal · metale · metaal · metal · metallo · metal · metalli · metal



STRAHLER · SPOT
excl. 1 x GU10, max. 25 W



- 78240107 | Nickel matt · nickel mat
- 78240108 | Messing matt · brass mat
- 78240131 | Weiß matt · white mat
- 78240132 | Schwarz matt · black mat



PENDELLEUCHTE · PENDANT
excl. 1 x GU10, max. 25 W



- 73240107 | Nickel matt · nickel mat
- 73240108 | Messing matt · brass mat
- 73240131 | Weiß matt · white mat
- 73240132 | Schwarz matt · black mat

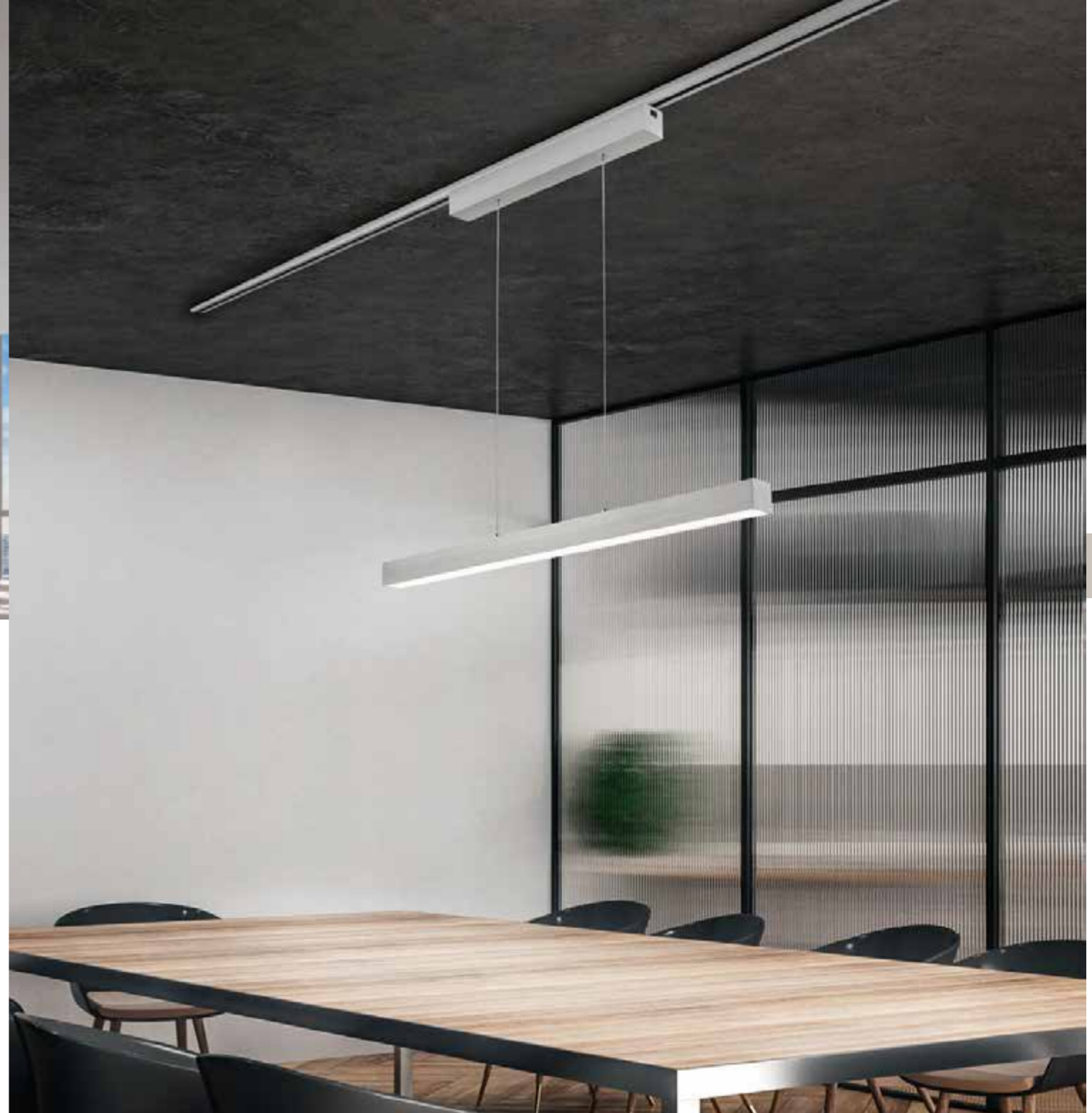

PAROS

Metall · metal · metale · metaal · metal · metallo · metal · metalli · metal

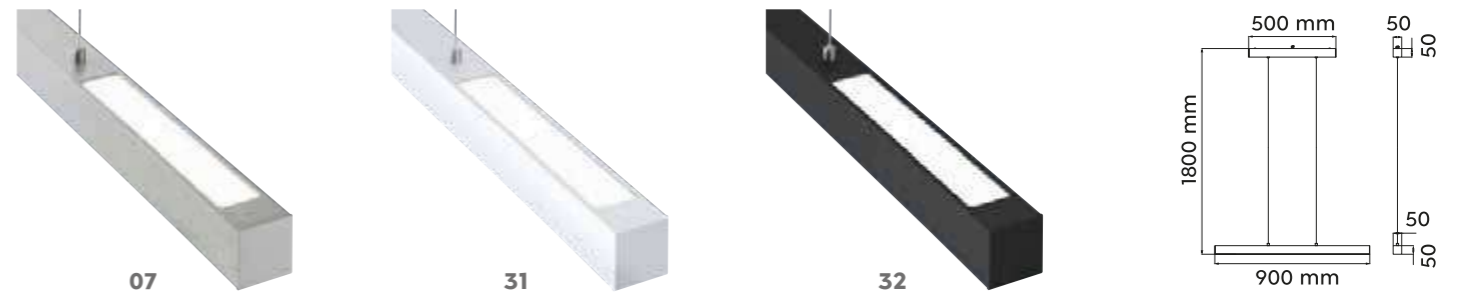

PENDELLEUCHTE · PENDANT
incl. SMD-LED, 29 W
3.400 lm, 3.000 K



- 73043107 | Nickel matt · nickel mat
- 73043131 | Weiß matt · white mat
- 73043132 | Schwarz matt · black mat

ONTARIO

Glas Weiß · glass white · verre blanc ·
glas wit · vidrio blanco · vetro bianco ·
sticla alb · lasi valkoinen · szkło biały

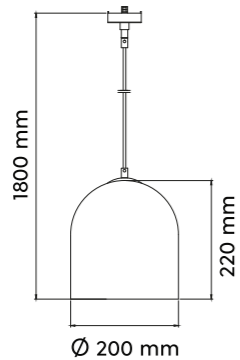

PENDELLEUCHTE · PENDANT
excl. 1 x E14, max. 25 W



73520101 | Weiß · white

ANTIBES

Metall, Glas Weiß · metal, glass white · metale, verre blanc ·
metaal, glas wit · metal, vidrio blanco · metallo, vetro bianco ·
metal, sticla alb · metalli, lasi valkoinen · metal, szkło biały

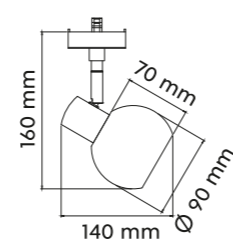

STRAHLER · SPOT
excl. 1 x GU10, max. 25 W



78170107 | Nickel matt · nickel mat

DIALLO

Metall · metal · metale · metaal · metal · metallo · metal · metalli · metal

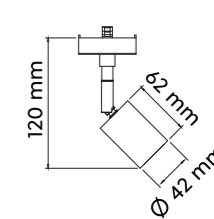

STRAHLER · SPOT
excl. 1 x E27, max. 25 W



78010107 | Nickel matt · nickel mat
78010131 | Weiß matt · white mat
78010132 | Schwarz matt · black mat

LUMINA

Metall, Schwarz matt, Glas chrom bedampft · Metal, black mat, chrome plated glass ·
métal, noir mat, verre plaqué chrome · metaal, mat zwart, chroom opgedampt glas · metal, estera negra, vidrio cromado ·
metallo, nero opaco, vetro verniciato cromo · metal, negru mat, sticla cromata · metalli, mattamusta, kromipäällystetty lasi ·
metal, czarny mat, szkło chromowane

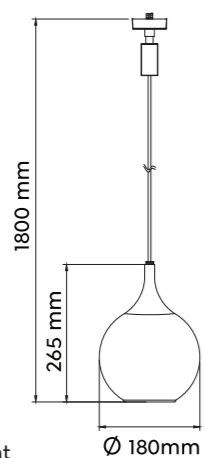

PENDELLEUCHTE · PENDANT
excl. 1 x E14, max. 40 W



73700132 | Schwarz matt · black mat

ROBIN

Metall, Glas · metal, glass ·
metale, verre · metaal, glas · metal, vidrio ·
metallo, vetro · metal, sticla · metalli, lasi · metal, szkło

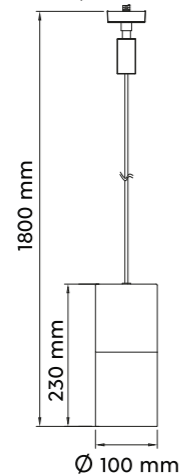

PENDELLEUCHTE · PENDANT
excl. 1 x E27, max. 28 W



73060132 | Schwarz matt · black mat



TOSH

Metall, Holz · metal, wood · metale, bois · metaal, hout · metal, madera ·
metallo, di legno · metal, lemn · metalli, puu · metal, drewno

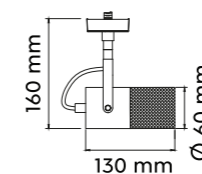

STRAHLER · SPOT
excl. 1 x E14, max. 25 W



78430132 | Schwarz matt · black mat

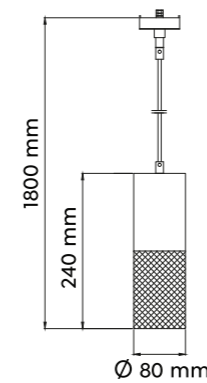

PENDELLEUCHTE · PENDANT
excl. 1 x E27, max. 25 W



73430132 | Schwarz matt · black mat



PANEL

Kunststoff · plastic · plastique · kunststof · plástico · plastica · plastic · muovi · plastik

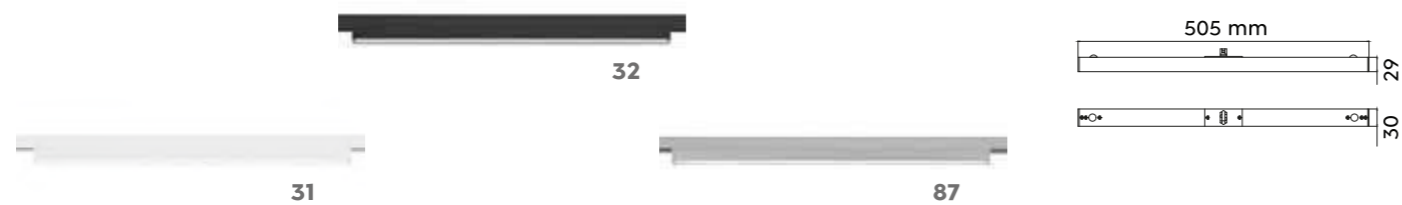

LED-PANEL
incl. SMD-LED, 6 W
850 lm, 3.000 K



- 77020131 | Weiß matt · white mat
- 77020132 | Schwarz matt · black mat
- 77020187 | titanfarbig · titan

498

CAMILLUS

Kunststoff · plastic · plastique · kunststof · plástico · plastica · plastic · muovi · plastik



LED-PANEL
incl. SMD-LED, 9 W
900 lm, 3.000 K



- 76921031 | Weiß matt · white mat
- 76921032 | Schwarz matt · black mat
- 76921087 | titanfarbig · titan



LED-PANEL
incl. SMD-LED, 13 W
1.400 lm, 3.000 K



- 76921531 | Weiß matt · white mat
- 76921532 | Schwarz matt · black mat
- 76921587 | titanfarbig · titan



499

HOTEL

Stoffschilder · fabric shade · abat-jour tissu · Stoffen kap · Pantalla de tela · paralume in tessuto · abajur textil · kangas varjostin · Klosz z materiału



01



11

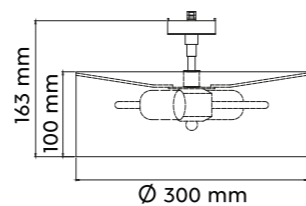

DECKENLEUCHTE · CEILING LAMP
excl. 2 x E27, max. 25 W



76390201 | Weiß · white
76390211 | Grau · grey



01



11

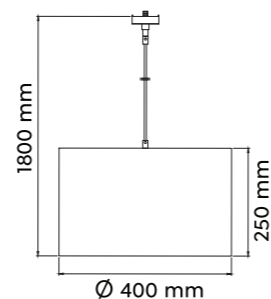

PENDELLEUCHTE · PENDANT
excl. 1 x E27, max. 25 W



73330101 | Weiß · white
73330111 | Grau · grey

TOMMY

Stoffschilder · fabric shade · abat-jour tissu · Stoffen kap · Pantalla de tela · paralume in tessuto · abajur textil · kangas varjostin · Klosz z materiału



01



11



79

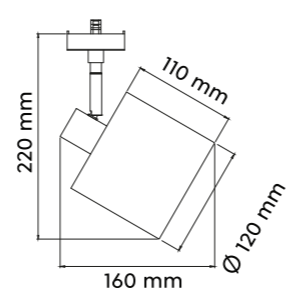

STRAHLER · SPOT
excl. 1 x E14, max. 25 W



78330101 | Weiß · white
78330111 | Grau · grey
78330179 | goldfarbig · gold

JIMMY

Metall, Schwarz · metal, black · metale, noir · metaal, zwart · metal, negro · metallo, nero · metal, negro · metalli, musta · metal, czarny



PENDELLEUCHTE · PENDANT
excl. 1 x E27, max. 25 W



73120102 | Schwarz-Gold · black-gold

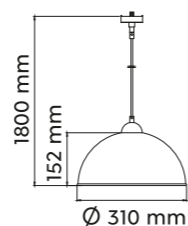

HOSTEL

Stoffschilder · fabric shade · abat-jour tissu · Stoffen kap · Pantalla de tela · paralume in tessuto · abajur textil · kangas varjostin · Klosz z materiału

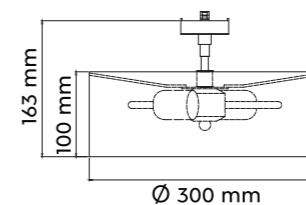

DECKENLEUCHTE · CEILING LAMP
excl. 2 x E27, max. 25 W



76820280 | Schwarz-Gold · black-gold

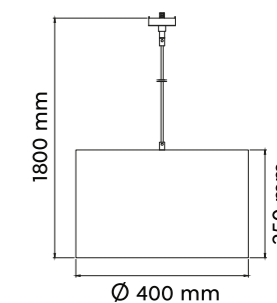

PENDELLEUCHTE · PENDANT
excl. 1 x E27, max. 25 W



73820180 | Schwarz-Gold · black-gold





Einbauleuchten

- Recessed lights
- Spots encastrés
- Inbouwspots
- Focos empotrables
- Faretti incasso
- Spoturi incastrate
- Upotetut spotit
- Oprawy wbudowane



AURA

Kunststoff, Chrom, Weiß matt oder Schwarz matt · plastic, chrome, white mat or black mat ·
 plastique, chrome, blanc mat ou noir mat · kunststof, chroom, wit mat of mat zwart · plástico, cromo, estera blanca o estera negra ·
 plastica, cromo, bianco opaco o nero opaco · plastic, crom, alb mat sau negru mat · muovi, kromi, mattavalkoinen tai mattamusta ·
 plastik, chrom, biały mat lub czarny mat



06 31 32

Einbauleuchte · Recessed light
 Ø 8,2 cm, ↑ 4 cm
 incl. 1 x SMD, 5 W
 450 lm, 3.000 K

652310106 | Chrom · chrome
 652310131 | Weiß matt · white mat
 652310132 | Schwarz matt · black mat



06 31 32

Einbauleuchte · Recessed light
 Ø 14,8 cm, ↑ 3,8 cm
 incl. 1 x SMD, 10 W
 1.040 lm, 3.000 K

652410106 | Chrom · chrome
 652410131 | Weiß matt · white mat
 652410132 | Schwarz matt · black mat

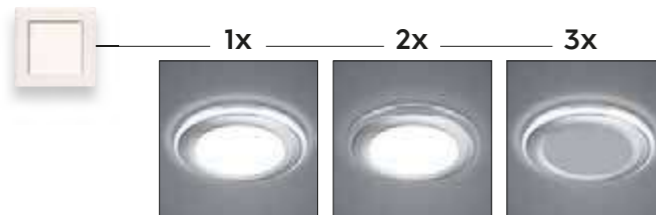

Getrennt schaltbar · Separately switchable
 Interrupteurs séparés · Gescheiden schakelbaar ·
 Interruptores separados · Interruttori separati ·
 Intreruptoare separate · Erikseen kytkettävissä ·
 Oddzileny przełącznik

CORE

Kunststoff, Chrom, Weiß matt oder Schwarz matt · plastic, chrome, white mat or black mat ·
 plastique, chrome, blanc mat ou noir mat · kunststof, chroom, wit mat of mat zwart · plástico, cromo, estera blanca o estera negra ·
 plastica, cromo, bianco opaco o nero opaco · plastic, crom, alb mat sau negru mat · muovi, kromi, mattavalkoinen tai mattamusta ·
 plastik, chrom, biały mat lub czarny mat



06 31 32

Einbauleuchte · Recessed light
 Ø 8,2 cm, ↑ 3,5 cm
 incl. 1 x SMD, 5 W
 450 lm, 3.000 K

652510106 | Chrom · chrome
 652510131 | Weiß matt · white mat
 652510132 | Schwarz matt · black mat



06 31 32

Einbauleuchte · Recessed light
 Ø 14,8 cm, ↑ 3,3 cm
 incl. 1 x SMD, 10 W
 1.040 lm, 3.000 K

652610106 | Chrom · chrome
 652610131 | Weiß matt · white mat
 652610132 | Schwarz matt · black mat

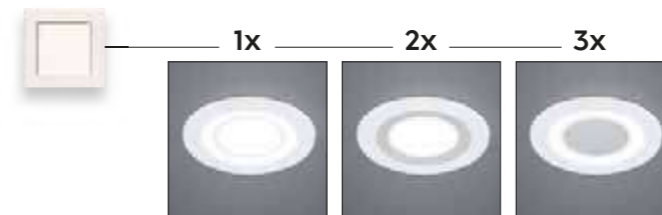

Getrennt schaltbar · Separately switchable
 Interrupteurs séparés · Gescheiden schakelbaar ·
 Interruptores separados · Interruttori separati ·
 Intreruptoare separate · Erikseen kytkettävissä ·
 Oddzileny przełącznik

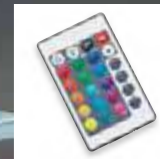

NIMBUS

Kunststoff, Chrom, Weiß matt oder Schwarz matt · plastic, chrome, white mat or black mat ·
 plastique, chrome, blanc mat ou noir mat · kunststof, chroom, wit mat of mat zwart · plástico, cromo, estera blanca o estera negra ·
 plastica, cromo, bianco opaco o nero opaco · plastic, crom, alb mat sau negru mat · muovi, kromi, mattavalkoinen tai mattamusta ·
 plastik, chrom, biały mat lub czarny mat



06

31

32

Einbauleuchte · Recessed light
 ↔ 8,5 x 8,5 cm, ↑ 4 cm
 incl. 1 x SMD, 5 W
 450 lm, 3.000 K

653410106 | Chrom · chrome
 653410131 | Weiß matt · white mat
 653410132 | Schwarz matt · black mat

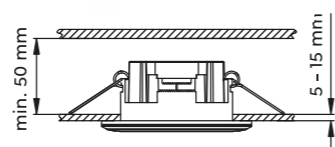

ARGUS

Kunststoff, Chrom, Weiß matt oder Schwarz matt · plastic, chrome, white mat or black mat ·
 plastique, chrome, blanc mat ou noir mat · kunststof, chroom, wit mat of mat zwart · plástico, cromo, estera blanca o estera negra ·
 plastica, cromo, bianco opaco o nero opaco · plastic, crom, alb mat sau negru mat · muovi, kromi, mattavalkoinen tai mattamusta ·
 plastik, chrom, biały mat lub czarny mat



06

31

32

Einbauleuchte · Recessed light
 Ø 8,2 cm, ↑ 4 cm
 incl. 1 x SMD, 4 W
 350 lm, 3.000 K
 incl. 1 x RGB-LED, 1 W

653610106 | Chrom · chrome
 653610131 | Weiß matt · white mat
 653610132 | Schwarz matt · black mat

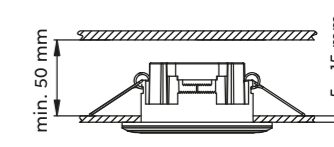

3er Set / Set 3

653610306 | Chrom · chrome
 653610331 | Weiß matt · white mat
 653610332 | Schwarz matt · black mat

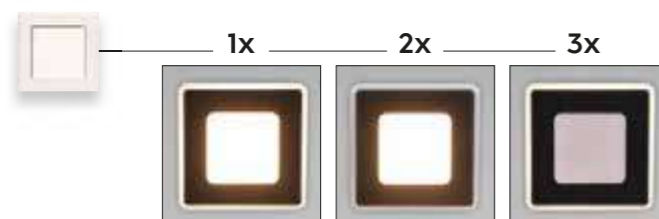

Getrennt schaltbar · Separately switchable
 Interrupteurs séparés · Gescheiden schakelbaar ·
 Interruptores separados · Interruttori separati ·
 Intreruptoare separate · Erikseen kytkettävissä ·
 Oddzileny przełącznik



Getrennt schaltbar · Separately switchable
 Interrupteurs séparés · Gescheiden schakelbaar ·
 Interruptores separados · Interruttori separati ·
 Intreruptoare separate · Erikseen kytkettävissä ·
 Oddzileny przełącznik



ZAGROS

Metall · metal ·
metale · metaal · metal · metallo · metal · metalli · metal ·



Einbauleuchte · Recessed light

↔ 8,5 cm, ↑ 5,4 cm
incl. 1 x SMD, 5,5 W
345 lm, 3.000 K

650710106 | Chrom · chrome
650710107 | Nickel matt · nickel mat
650710131 | Weiß matt · white mat
650710132 | Schwarz matt · black mat



Einbauleuchte · Recessed light

↔ 8,5 x 8,5 cm, ↑ 5,4 cm
incl. 1 x SMD, 5,5 W
345 lm, 3.000 K

650610106 | Chrom · chrome
650610107 | Nickel matt · nickel mat
650610131 | Weiß matt · white mat
650610132 | Schwarz matt · black mat



PAMIR

Metall · metal ·
metale · metaal · metal · metallo · metal · metalli · metal ·



Einbauleuchte · Recessed light

↔ 8,5 cm, ↑ 5,4 cm
incl. 1 x SMD, 5,5 W
345 lm, 3.000 K

650510106 | Chrom · chrome
650510107 | Nickel matt · nickel mat
650510131 | Weiß matt · white mat
650510132 | Schwarz matt · black mat



Einbauleuchte · Recessed light

↔ 8,5 x 8,5 cm, ↑ 5,4 cm
incl. 1 x SMD, 5,5 W
345 lm, 3.000 K

650410106 | Chrom · chrome
650410107 | Nickel matt · nickel mat
650410131 | Weiß matt · white mat
650410132 | Schwarz matt · black mat



Empfohlen:
recommended: LED GU10, 3 W
250 lm, 3.000 K



956-30

PIRIN

Kristallglas · crystal glass ·
verre cristal · kristal glas · vidrio cristal · vetro cristallo · sticla cristal · kristallilasi · szkło kryształ



Einbauleuchte · Recessed light
Ø 9 cm, ↑ 7 cm
excl. 1 x GU10, max. 10 W



652100152

Einbauleuchte · Recessed light
↔ 9 x 9 cm, ↑ 7 cm
excl. 1 x GU10, max. 10 W



652200152

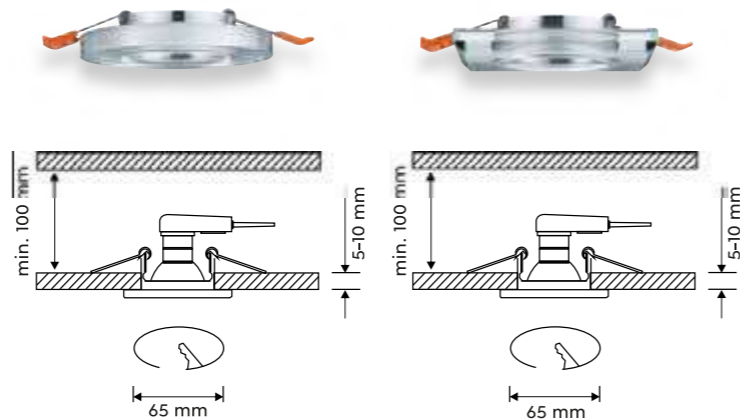

DOLOMITE

Kristallglas · crystal glass ·
verre cristal · kristal glas · vidrio cristal · vetro cristallo · sticla cristal · kristallilasi · szkło kryształ



Einbauleuchte · Recessed light
Ø 9 cm, ↑ 9,5 cm
excl. 1 x GU10, max. 10 W



651700152

Einbauleuchte · Recessed light
↔ 10 x 10 cm, ↑ 9,5 cm
excl. 1 x GU10, max. 10 W



651800152

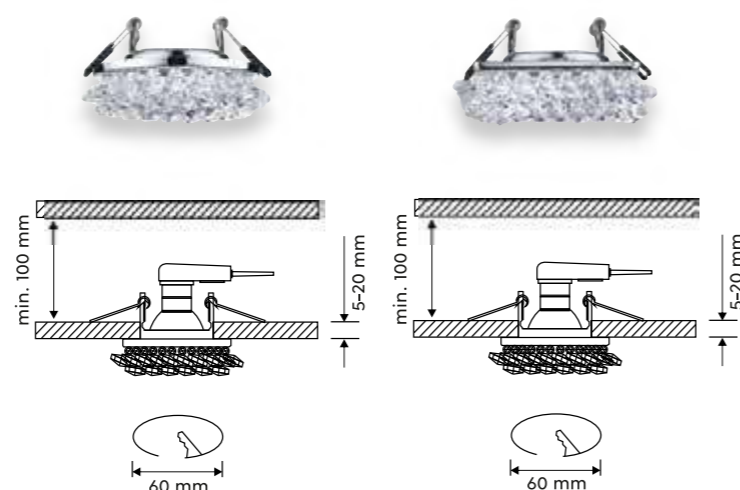

RILA

Metall · metal ·
metale · metaal · metal · metallo · metal · metalli · metal ·



Schwenkbar ·
Tilttable



06



07



31

Einbauleuchte · Recessed light
Ø 8,2 cm, ↑ 3,4 cm
incl. 1 x SMD, 5 W
450 lm, 3.000 K



06



07



31

Einbauleuchte · Recessed light
↔ 8 x 8 cm, ↑ 3,4 cm
incl. 1 x SMD, 5 W
450 lm, 3.000 K



650310106 | Chrom · chrome
650310107 | Nickel matt · nickel mat
650310131 | Weiß matt · white mat

650210106 | Chrom · chrome
650210107 | Nickel matt · nickel mat
650210131 | Weiß matt · white mat

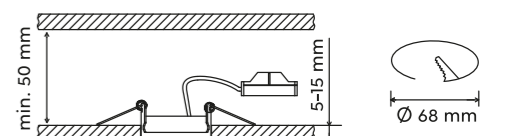
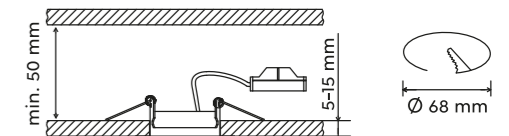

KENAI

Metall · metal ·
metale · metaal · metal · metallo · metal · metalli · metal

 Schwenkbar ·
Tilttable



31

32

Einbauleuchte · Recessed light
Ø 9,2 cm, ↑ 10 cm
excl. 1 x GU10, max. 15 W

651500131 | Weiß matt · white mat
651500132 | Schwarz matt · black mat

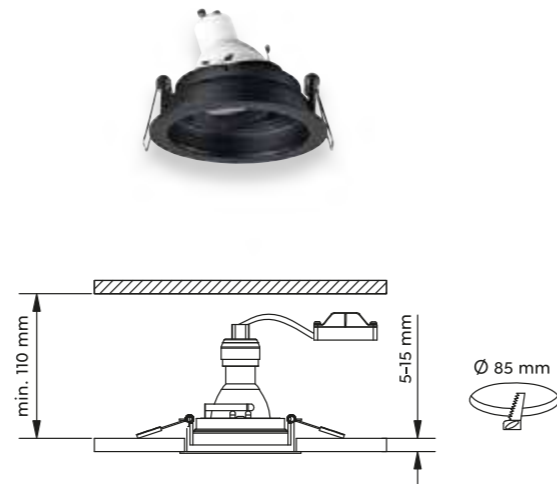

31

32

Einbauleuchte · Recessed light
↔ 9,2 x 9,2 cm, ↑ 10 cm
excl. 1 x GU10, max. 15 W

651600131 | Weiß matt · white mat
651600132 | Schwarz matt · black mat

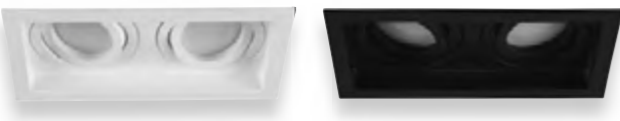
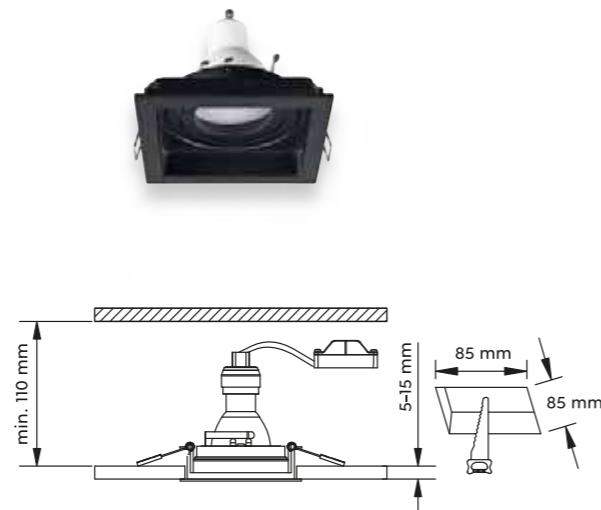

31

32

Einbauleuchte · Recessed light
↔ 17,2 x 9,2 cm, ↑ 10 cm
excl. 2 x GU10, max. 15 W

651600231 | Weiß matt · white mat
651600232 | Schwarz matt · black mat

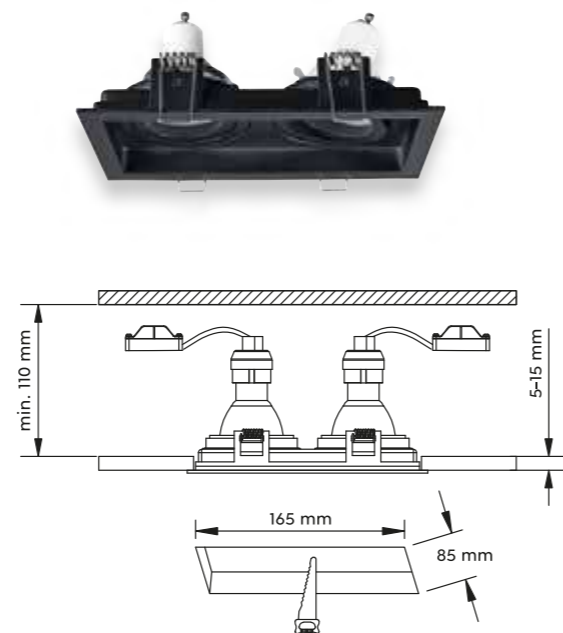

Empfohlen:
recommended: LED GU10, 4,5 W
345 lm, 3.000 K



956-55

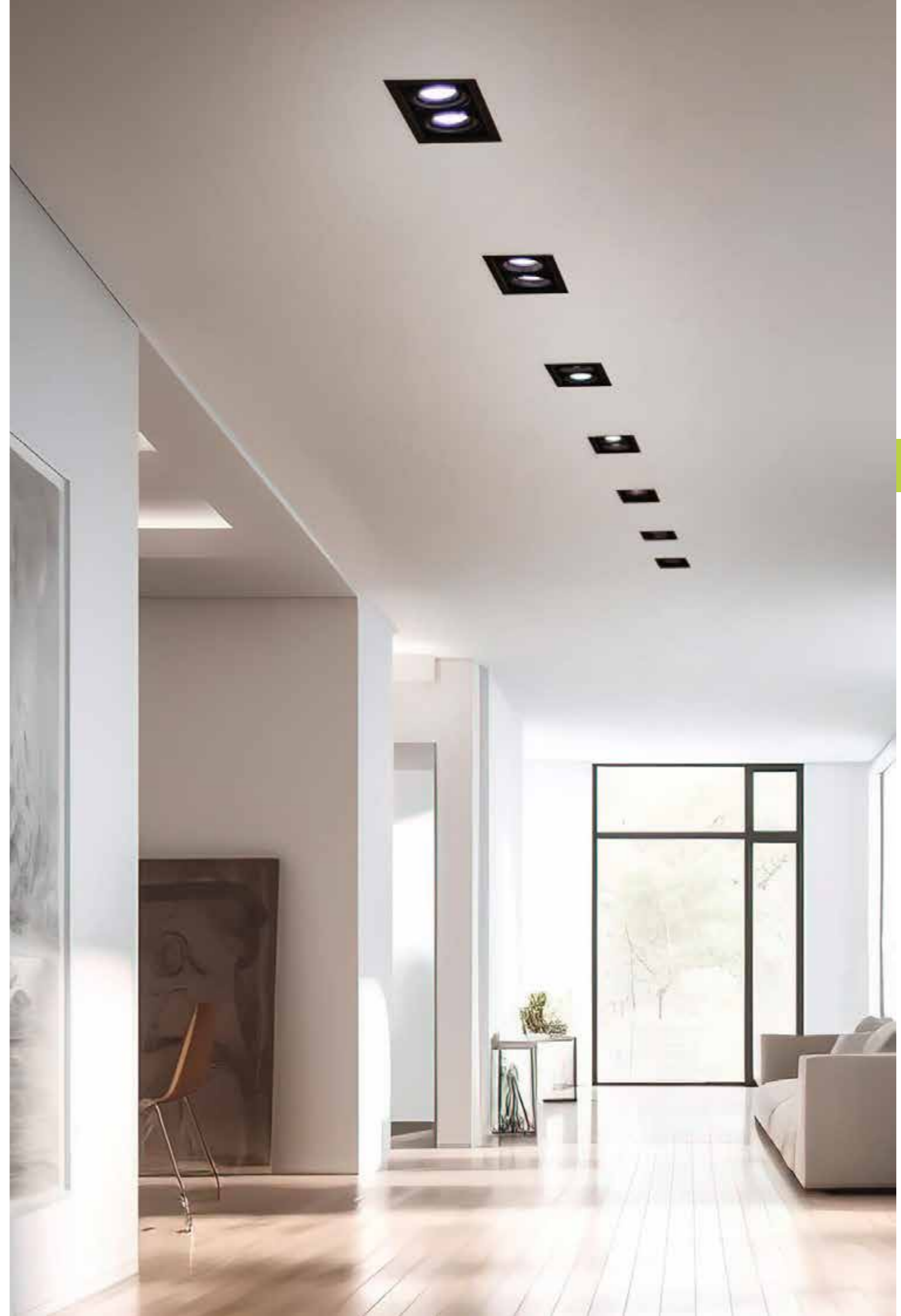

JURA

Metall · metal ·
metale · metaal · metal · metallo · metal · metalli · metal ·

 Schwenkbar ·
Tilttable



06

07

08



31

32

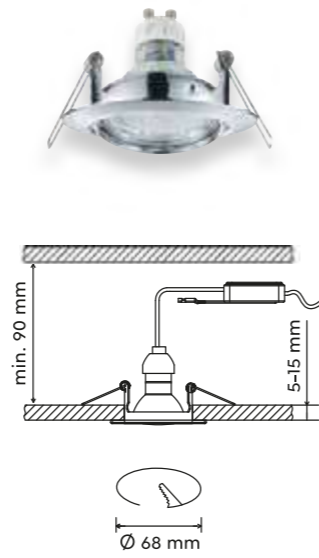

Einbauleuchte · Recessed light
Ø 8,3 cm, ↑ 7 cm
excl. 1 x GU10, max. 15 W



- 650100106 | Chrom · chrome
- 650100107 | Nickel matt · nickel mat
- 650100108 | Messing matt · brass mat
- 650100131 | Weiß matt · white mat
- 650100132 | Schwarz matt · black mat

Empfohlen:
recommended: LED GU10, 3 W
250 lm, 3.000 K



956-30



06

07

08



31

32

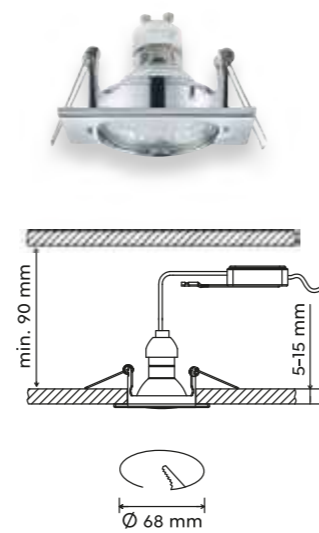

Einbauleuchte · Recessed light
↔ 8 x 8 cm, ↑ 7 cm
excl. 1 x GU10, max. 15 W



- 650000106 | Chrom · chrome
- 650000107 | Nickel matt · nickel mat
- 650000108 | Messing matt · brass mat
- 650000131 | Weiß matt · white mat
- 650000132 | Schwarz matt · black mat



07

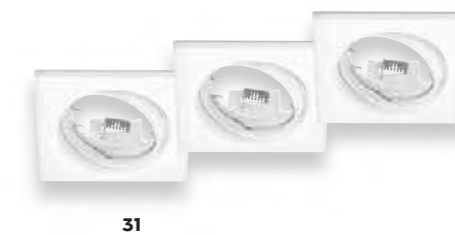

31

3er Set / Set 3

- 650100306 | Chrom · chrome
- 650100307 | Nickel matt · nickel mat
- 650100331 | Weiß matt · white mat

3er Set / Set 3

- 650000306 | Chrom · chrome
- 650000307 | Nickel matt · nickel mat
- 650000331 | Weiß matt · white mat



Badezimmerleuchten

Bathroom lighting
Éclairage salle de bains
Badkamer verlichting
Iluminación de cuarto de baño
Illuminazione per bagno
Iluminat baie
Kylpyhuone valaistus
Oświetlenie łazienkowe



BOLSA

Chrom, Acryl · chrome, acryl ·
 chrome, acryl · chroom, acryl · cromo, acrílico ·
 cromo, acrílico · crom, acrílic · kromi, akryyli ·
 chrom, akryl



Wandleuchte · Wall lamp
 ↑ 19 cm, ↔ 7 cm, ↗ 12 cm
 incl. 1 x SMD-LED, 3,1 W
 310 lm, 3.000 K



282410106



Wandleuchte · Wall lamp
 ↑ 30 cm, ↔ 7 cm, ↗ 12 cm
 incl. 2 x SMD-LED, 3,1 W
 2 x 310 lm, 3.000 K



282410206



Deckenleuchte · Ceiling lamp
 Ø 41,5 cm, ↑ 16,5 cm
 incl. 5 x SMD-LED, 3,1 W
 5 x 310 lm, 3.000 K



682410506



RAY

Kunststoff, Chrom oder Schwarz matt · plastic, chrome or black mat ·
 plastique, chrome ou noir mat · kunststof, chroom of mat zwart ·
 plástico, cromo o estera negra · plastica, cromo o nero opaco ·
 plastic, crom sau negru mat · muovi, kromi tai mattamusta ·
 plastik, chrom lub czarny mat

IP44

06 | Chrom · chrome

32 | Schwarz matt · black mat



Wandleuchte · Wall lamp
 ↑ 8,3 x 5,2 cm, ↗ 8 cm
 incl. 1 x SMD-LED, 4 W
 340 lm, 3.000 K



283110106
 283110132



Wandleuchte · Wall lamp
 ↑ 16,6 x 5,2 cm, ↗ 8 cm
 incl. 2 x SMD-LED, 4 W
 2 x 340 lm, 3.000 K



283110206
 283110232

KULA

Metall, Chrom oder Schwarz matt · metal, chrome or black mat ·
 metale, chrome ou noir mat · metaal, chroom of mat zwart ·
 metal, cromo o estera negra · metallo, cromo o nero opaco ·
 metal, crom sau negru mat · metalli, kromi tai mattamusta ·
 metal, chrom lub czarny mat

IP44

06 | Chrom · chrome

32 | Schwarz matt · black mat



Wandleuchte · Wall lamp
 ↓ 20 cm, ↔ 14 cm, ↗ 17 cm
 excl. 1 x E14, max. 10 W



284270106
 284270132





ROCCO

Metall, Chrom oder Schwarz matt · metal, chrome or black mat ·
 metale, chrome ou noir mat · metaal, chroom of mat zwart · metal, cromo o estera negra ·
 metallo, cromo o nero opaco · metal, crom sau negru mat · metalli, kromi tai mattamusta ·
 metal, chrom lub czarny mat



IP44



06 | Chrom · chrome

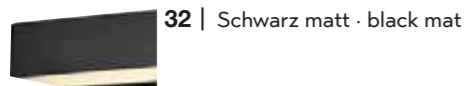

32 | Schwarz matt · black mat

Wandleuchte · Wall lamp
 ↔ 60 x 3,6 cm, ↗ 8 cm
 incl. SMD-LED, 8 W
 800 lm, 3.000 K



283916006
 283916032

Wandleuchte · Wall lamp
 ↔ 90 x 3,6 cm, ↗ 8 cm
 incl. SMD-LED, 13 W
 1.400 lm, 3.000 K



283919006
 283919032



FABIO

Metall, Chrom oder Schwarz matt · metal, chrome or black mat ·
 metale, chrome ou noir mat · metaal, chroom of mat zwart · metal, cromo o estera negra ·
 metallo, cromo o nero opaco · metal, crom sau negru mat · metalli, kromi tai mattamusta ·
 metal, chrom lub czarny mat



IP44



06 | Chrom · chrome

32 | Schwarz matt · black mat

Wandleuchte · Wall lamp
 ↔ 42,5 x 3,8 cm, ∅ 7,9 cm
 incl. SMD-LED, 6 W
 700 lm, 3.000 K



283814206
 283814232

Wandleuchte · Wall lamp
 ↔ 80 x 3,8 cm, ∅ 7,9 cm
 incl. SMD-LED, 12 W
 1.400 lm, 3.000 K



283817906
 283817932

Wandleuchte · Wall lamp
 ↔ 120 x 3,8 cm, ∅ 7,9 cm
 incl. SMD-LED, 20 W
 2.300 lm, 3.000 K



283811206
 283811232



PIERA

Kunststoff, Chrom oder Schwarz matt · plastic, chrome or black mat ·
 plastique, chrome ou noir mat · kunststof, chrom of mat zwart · plástico, cromo o estera negra ·
 plastica, cromo o nero opaco · plastic, crom sau negru mat · muovi, kromi tai mattamusta ·
 plastik, chrom lub czarny mat



Wandleuchte · Wall lamp
 ↔ 41,5 x 5,5 cm, ∅ 7 cm
 incl. SMD-LED, 8 W
 850 lm, 3.000 K



284074206
 284074232



Wandleuchte · Wall lamp
 ↔ 79 x 5,5 cm, ∅ 7 cm
 incl. SMD-LED, 16 W
 1.650 lm, 3.000 K



284077906
 284077932



Wandleuchte · Wall lamp
 ↔ 119 x 5,5 cm, ∅ 7 cm
 incl. SMD-LED, 21 W
 2.200 lm, 3.000 K



284071206
 284071232

IP44



06 | Chrom · chrome



32 | Schwarz matt · black mat

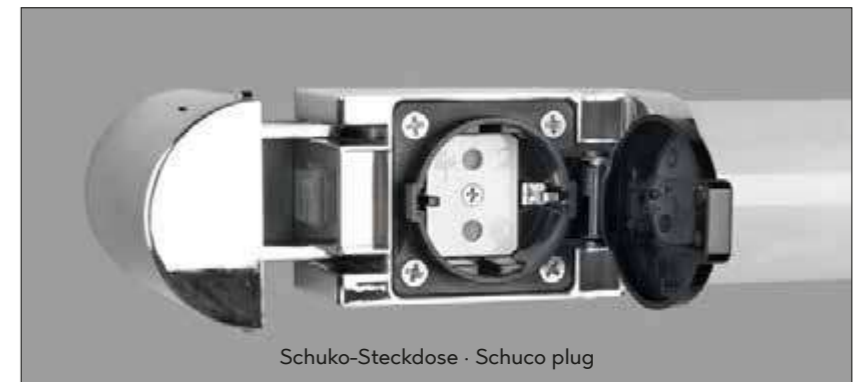

Schuko-Steckdose · Schuco plug



Wandleuchte · Wall lamp
 ↔ 40,4 x 5,5 cm, ∠ 8,5 cm
 incl. 1 x SMD-LED, 4,3 W
 450 lm, 3.000 K



283270106
 283270132



Wandleuchte · Wall lamp
 ↔ 60,4 x 5,5 cm, ∠ 8,8 cm
 incl. 1 x SMD-LED, 6,5 W
 680 lm, 3.000 K



283270206
 283270232



Wandleuchte · Wall lamp
 ↔ 80,4 x 5,5 cm, ∠ 8,8 cm
 incl. 1 x SMD-LED, 8,6 W
 880 lm, 3.000 K



283270306
 283270332

MATTIMO

Metall, Kunststoff, Chrom oder Schwarz matt · metal, plastic, chrome or black mat ·
 metale, plastique, chrome ou noir mat · metaal, kunststof, chroom of mat zwart · metal, plástico, cromo o estera negra ·
 metallo, plastica, cromo o nero opaco · metal, plastic, crom sau negru mat · metalli, muovi, kromi tai mattamusta ·
 metal, plastik, chrom lub czarny mat



06 | Chrom · chrome



32 | Schwarz matt · black mat



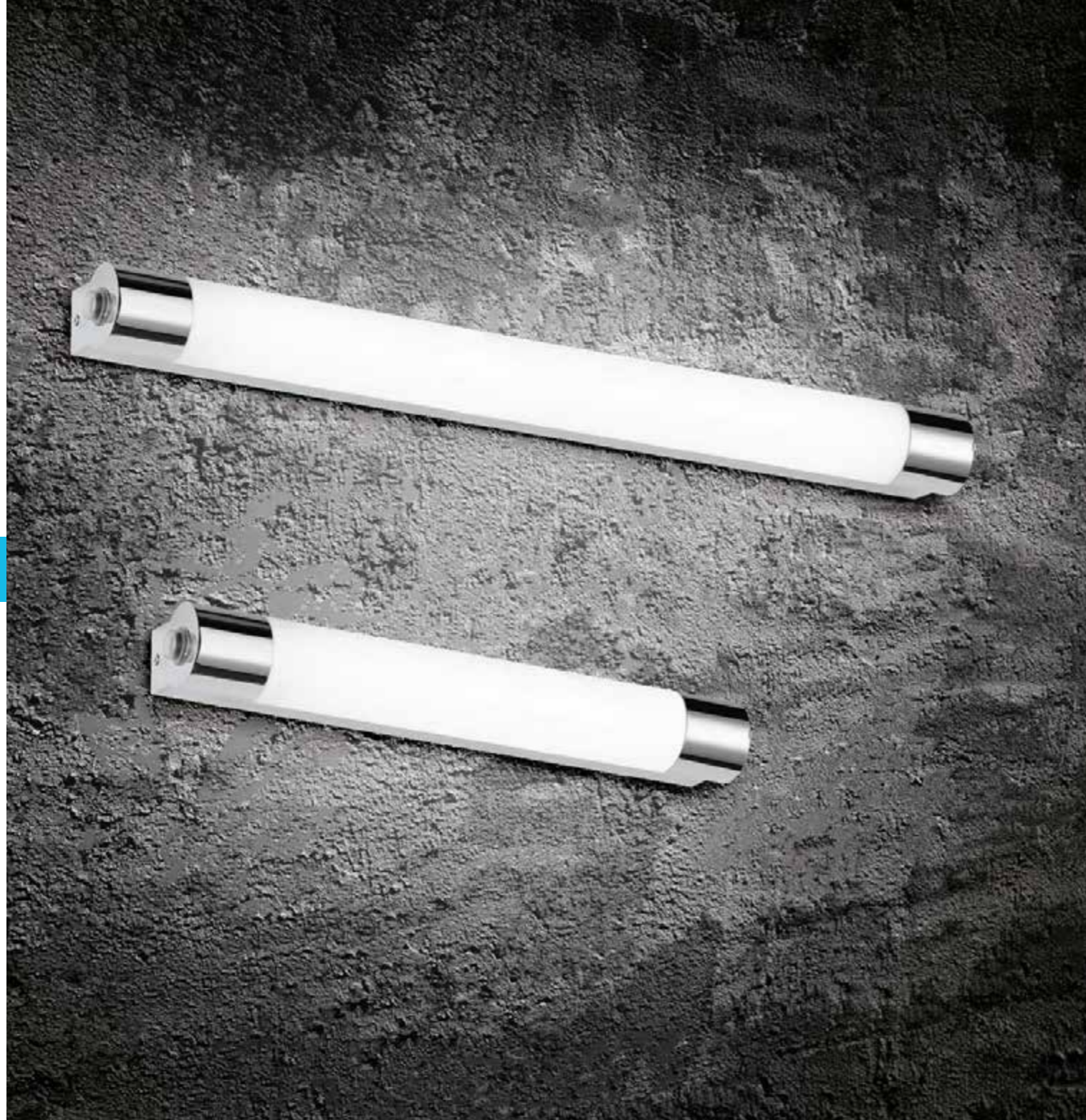

KOLIAN

Kunststoff, Chrom · plastic, chrome ·
plastique, chrome · kunststof, chrom · plástico, cromo · plastica, cromo · plastic, crom · muovi, kromi · plastik, chrom



IP44 Steckdose - Plug



Wandleuchte · Wall lamp
↔ 44 x 6 cm, √ 9 cm
incl. SMD-LED, 6 W
700 lm, 3.000 K



281570606



Wandleuchte · Wall lamp
↔ 64 x 6 cm, √ 9 cm
incl. SMD-LED, 9 W
970 lm, 3.000 K



281570906





VIEW

Chrom · chrome · chrome · chroom · cromo · cromo · crom · kromi · chrom

IP44

On/Off Touch Funktion · On/Off Touch function

3x Vergrößerung 3x · Magnification 3x



Wandleuchte · Wall lamp
 Ø 21 cm, √ max. 36 cm
 incl. SMD-LED, 3 W
 280 lm, 3.000 K



282990106



THEATRO

Chrom · chrome · chrome · chroom · cromo · cromo · crom · kromi · chrom

IP44

Empfohlen:
 recommended: Filament LED E27, 4 W
 420 lm, 2.800 K



987-410



Wandleuchte · Wall lamp
 ↔ 55 x 8 cm, √ 6,5 cm
 excl. 4 x E27, max. 28 W



283600406



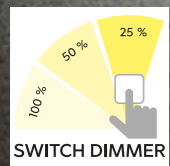

ASCARI

Metall, Chrom oder Schwarz matt · metal, chrome or black mat ·
 metale, chrome ou noir mat · metaal, chroom of mat zwart · metal, cromo o estera negra ·
 metallo, cromo o nero opaco · metal, crom sau negru mat · metalli, kromi tai mattamusta ·
 metal, chrom lub czarny mat

IP44



Deckenleuchte · Ceiling lamp
 Ø 30 cm, ↓ 6,8 cm
 incl. SMD-LED, 28 W
 3.200 lm, 3.000 K

Deckenleuchte · Ceiling lamp
 Ø 40 cm, ↓ 6,8 cm
 incl. SMD-LED, 35 W
 4.100 lm, 3.000 K



680810306
 680810332



680819306
 680819332



06 | Chrom · chrome

32 | Schwarz matt · black mat



GIANNI

Metall, Chrom oder Schwarz matt · metal, chrome or black mat ·
 metale, chrome ou noir mat · metaal, chroom of mat zwart · metal, cromo o estera negra ·
 metallo, cromo o nero opaco · metal, crom sau negru mat · metalli, kromi tai mattamusta ·
 metal, chrom lub czarny mat



IP44



Wandleuchte · Wall lamp
 ↔ 40 x 17,5 cm, ↗ 14,8 cm
 incl. SMD-LED, 17 W
 1.700 lm, 3.000 K

Wandleuchte · Wall lamp
 ↔ 60 x 8 cm, ↗ 15 cm
 incl. SMD-LED, 22 W
 2.700 lm, 3.000 K



283770106
 283770132



283779106
 283779132



06 | Chrom · chrome

32 | Schwarz matt · black mat



ANGELO

Metall, Chrom oder Schwarz matt · metal, chrome or black mat ·
 metale, chrome ou noir mat · metaal, chroom of mat zwart · metal, cromo o estera negra ·
 metallo, cromo o nero opaco · metal, crom sau negru mat · metalli, kromi tai mattamusta · metal, chrom lub czarny mat



Strahler · Spot
 Ø 10,5 cm, 15,5 cm
 excl. 1 x GU10, max. 5 W



880400106
 880400132

Strahler · Spot
 Ø 20 cm, 19,5 cm
 excl. 3 x GU10, max. 5 W



880430306
 880430332

Strahler · Spot
 52 x 9,5 cm, 19,5 cm
 excl. 4 x GU10, max. 5 W



880400406
 880400432

IP44

Empfohlen:
 recommended: LED GU10, 3 W
 250 lm, 3.000 K



956-30



06 | Chrom · chrome



32 | Schwarz matt · black mat



CAMILLA

Kunststoff, Schwarz matt · plastic, black mat ·
plastique, noir mat · kunststof, mat zwart · plástico, estera negra ·
plastica, nero opaco · plastic, negru mat · muovi, mattamusta · plastik, czarny mat

IP44

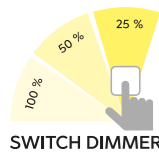

Deckenleuchte · Ceiling lamp
Ø 40 cm, ↑ 3 cm
incl. SMD-LED, 22 W
2.700 lm, 3.000 K



689214032



Deckenleuchte · Ceiling lamp
↔ 40 x 40 cm, ↑ 3 cm
incl. SMD-LED, 22 W
2.700 lm, 3.000 K



689314032



CINZIA

Chrom, Acryl mit Kristalleffekt · chrome, broken glass optic ·
chrome, optique verre pilé · chroom, Gebroken glas optiek ·
cromo, Efecto cristal roto · cromo, effetto ottico vetro rotto ·
chrom, aspect de sticla sparta · kromi, lasi efekti optiikka ·
chrom, Optyczne rozbite szkło



IP44

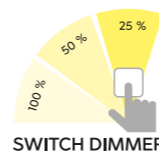

Deckenleuchte · Ceiling lamp
Ø 40 cm, ↑ 3 cm
incl. SMD-LED, 22 W
2.700 lm, 3.000 K



686412406



Deckenleuchte · Ceiling lamp
↔ 40 x 40 cm, ↑ 3 cm
incl. SMD-LED, 22 W
2.700 lm, 3.000 K



686512406



APART

Kunststoff, Chrom · plastic, chrome ·
plastique, chrome · kunststof, chroom · plástico, cromo ·
plastica, cromo · plastic, crom · muovi, kromi · plastik, chrom

IP44



Deckenleuchte · Ceiling lamp
Ø 35 cm, ↑ 10 cm,
incl. SMD-LED, 18 W
1.850 lm, 3.000 K



659411806



Deckenleuchte · Ceiling lamp
Ø 41 cm, ↑ 10 cm,
incl. SMD-LED, 22 W
2.500 lm, 3.000 K



659412406

UMBERTO

Kunststoff, Chrom oder Schwarz matt · plastic, chrome or black mat ·
plastique, chrome ou noir mat · kunststof, chroom of mat zwart · plástico, cromo o estera negra ·
plastica, cromo o nero opaco · plastic, crom sau negru mat · muovi, kromi tai mattamusta ·
plastik, chrom lub czarny mat

IP44



06 | Chrom · chrome



32 | Schwarz matt · black mat



Deckenleuchte · Ceiling lamp
Ø 29 cm, ↑ 8 cm
incl. SMD-LED, 12 W
1.160 lm, 3.000 K



680310106
680310132



Deckenleuchte · Ceiling lamp
Ø 42 cm, ↑ 10 cm
incl. SMD-LED, 18,5 W
1.900 lm, 3.000 K



680319106
680319132





PAOLO

Kunststoff, Weiß · plastic, white ·
plastique, blanc · kunststof, wit · plástico, blanco ·
plastica, bianco · plastic, alb · muovi, valkoinen · plastik, biały

IP44



Deckenleuchte · Ceiling lamp
Ø 37 cm, ↑ 8,5 cm
incl. SMD-LED, 15 W
1.500 lm, 3.000 K



686014001



Deckenleuchte · Ceiling lamp
Ø 37 cm, ↑ 8,5 cm
incl. SMD-LED, 15 W
1.500 lm, 4.000 K



686014000



FRODENO

Acryl · acryl ·
acryl · acryl · acrílico · acrilico · acrilic · akryyli · akryl

IP44

RGBW Farbwechsler ·
RGBW Colorchanging

Memory Funktion ·
Memory function

Starlight Effekt ·
Starlight effect



Deckenleuchte · Ceiling lamp
Ø 35 cm, ↑ 8,7 cm
incl. RGBW-LED, 12 W
1.200 lm, 4.000 K



680213500



Deckenleuchte · Ceiling lamp
Ø 48 cm, ↑ 10,2 cm
incl. RGBW-LED, 18,5 W
1.900 lm, 4.000 K



680214800





XAVI

Chrom, Glas matt · chrome, mat glass ·
 chrome, verre mat · chroom, mat glas · cromo, vidrio mate ·
 cromo, vetro sabbato · crom, sticla mata · kromi, mattalasi ·
 chrom, szkło matowane

IP21

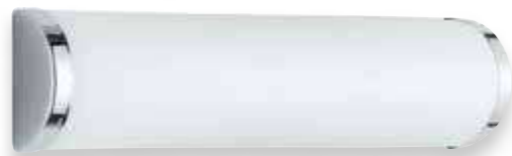

Empfohlen:
 recommended: LED E14, 4,5 W
 470 lm, 2.700 K



989-400

Wandleuchte · Wall lamp
 ↔ 30,5 cm, ↑ 8,3 cm, ↘ 6,3 cm
 excl. 2 x E14, max. 40 W



2803021-06

Wandleuchte · Wall lamp
 ↔ 40,5 cm, ↑ 8,3 cm, ↘ 6,3 cm
 excl. 3 x E14, max. 40 W



2803031-06



CONDUS

Metall, Glas matt · metal, mat glass ·
 metale, verre mat · metaal, mat glas ·
 metal, vidrio mate · metallo, vetro sabbato ·
 metal, sticla mata · metalli, mattalasi ·
 metal, szkło matowane

IP44

Empfohlen:
 recommended: LED E27, 4 W
 470 lm, 2.700 K



987-400

01 | Weiß · white

06 | Chrom · chrome

07 | Nickel matt · nickel mat

32 | Schwarz matt · black matt

Deckenleuchte · Ceiling lamp
 Ø 31,5 cm, ↑ 8 cm
 excl. 1 x E27, max. 60 W



6801011-01
 6801011-06
 6801011-07
 6801011-32





ZENIA

Metall · metal ·
metale · metaal · metal · metallo · metal · metalli · metal

IP65

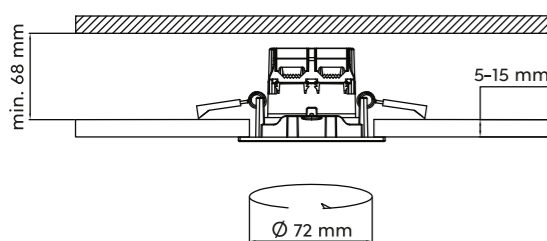

06 | Chrom · chrome



31 | Weiß matt · white mat



32 | Schwarz matt · black mat

Einbauleuchte · Recessed spot
Ø 8,5 cm, ↑ 5,4 cm
incl. SMD-LED, 5,5 W
345 lm, 3.000 K



680710106
680710131
680710132



CLARIMO

Kunststoff · plastic ·
plastique · kunststof · plástico · plastica · plastic · muovi · plastik

IP44



01 | Weiß · white



06 | Chrom · chrome



32 | Schwarz matt · black mat



87 | titanfarbig · titanium-coloured



Deckenleuchte · Ceiling lamp
Ø 33 cm, ↑ 9 cm,
incl. SMD-LED, 18 W
1.850 lm, 3.000 K



659011801
659011806
659011832
659011887

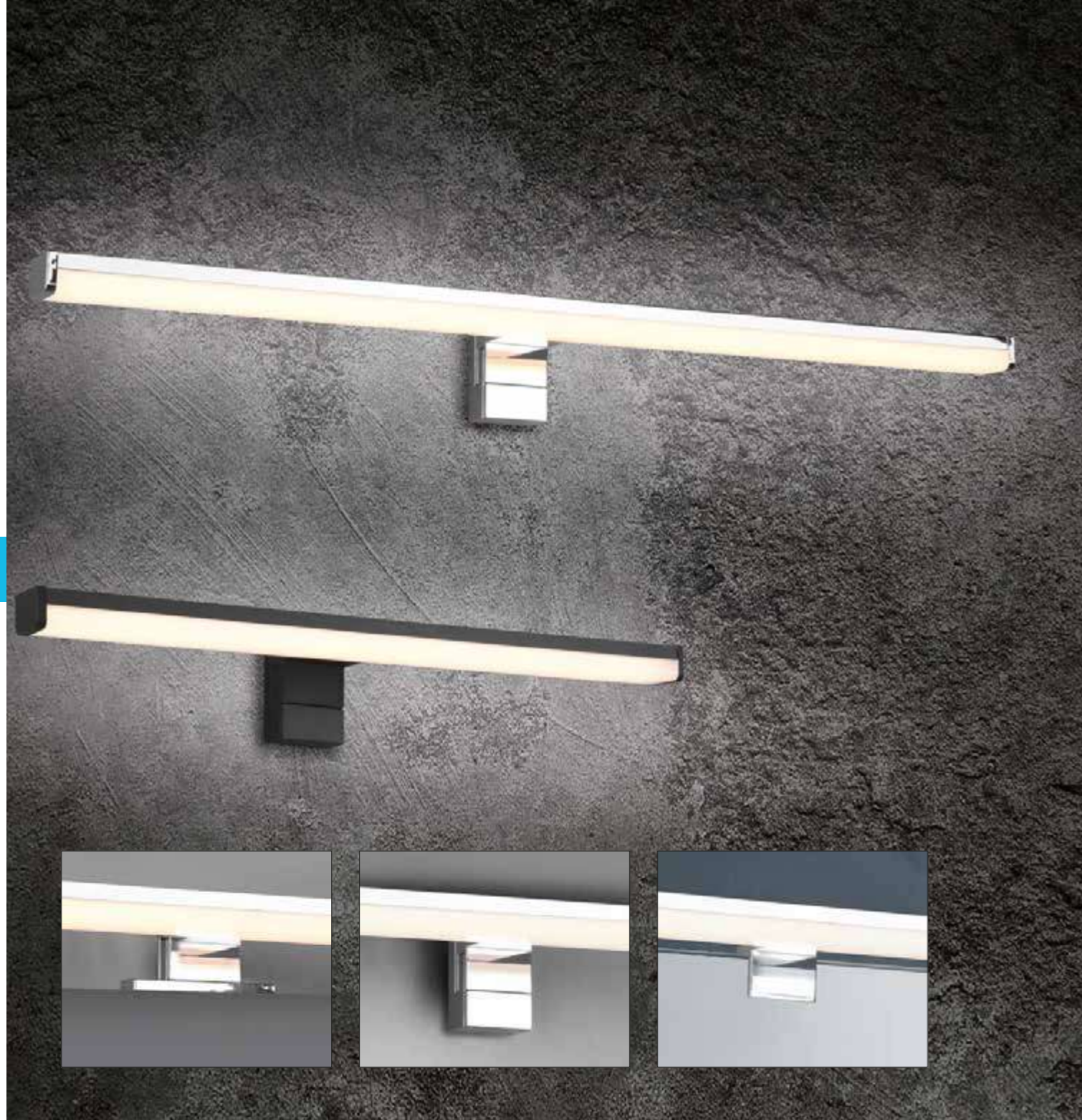

LINO

Kunststoff, Chrom oder Schwarz matt · plastic, chrome or black mat ·
 plastique, chrome ou noir mat · kunststof, chroom of mat zwart · plástico, cromo o estera negra ·
 plastica, cromo o nero opaco · plastic, crom sau negru mat · muovi, kromi tai mattamusta ·
 plastik, chrom lub czarny mat



IP44

 06 | Chrom · chrome

 32 | Schwarz matt · black mat



Wandleuchte · Wall lamp
 ↔ 40 x 6 cm, √ 10,5 cm
 incl. SMD-LED, 7,4 W
 900 lm, 3.000 K



284114006
 284114032



Wandleuchte · Wall lamp
 ↔ 60 x 6 cm, √ 10,5 cm
 incl. SMD-LED, 11 W
 1.350 lm, 3.000 K



284116006
 284116032





LORENZO

Metall, Chrom oder Schwarz matt · metal, chrome or black mat ·
metale, chrome ou noir mat · metaal, chroom of mat zwart · metal, cromo o estera negra ·
metallo, cromo o nero opaco · metal, crom sau negru mat · metalli, kromi tai mattamusta ·
metal, chrom lub czarny mat

IP44

Empfohlen:
recommended: LED GU10, 3 W
250 lm, 3.000 K



956-30



06 | Chrom · chrome



32 | Schwarz matt · black mat

Strahler · Spot
↓ 5,4 x 3,3 cm, ∅ 10,1 cm
excl. 1 x GU10, max. 5 W



283500106
283500132



GIADA

Metall, Chrom oder Schwarz matt · metal, chrome or black mat ·
metale, chrome ou noir mat · metaal, chroom of mat zwart · metal, cromo o estera negra ·
metallo, cromo o nero opaco · metal, crom sau negru mat · metalli, kromi tai mattamusta ·
metal, chrom lub czarny mat

IP44

Empfohlen:
recommended: LED GU10, 3 W
250 lm, 3.000 K



956-30



06 | Chrom · chrome



32 | Schwarz matt · black mat

Strahler · Spot
↓ 11,4 x 5,4 cm, ∅ 34,3 cm
excl. 1 x GU10, max. 5 W



283400106
283400132





Leuchtmittel

Light sources
Ampoules
Lichtbronnen
Fuentes de luz
Lampadine
Becuri
Valonlähdeet
Źródła światła

LED-LEUCHTMITTEL E27

LED bulbs E27 · Ampoules LED E27 · LED-lampen E27 · Bombillas a LED E27 ·
Lampadine a LED E27 · Becuri cu LED-uri E27 · LED-Valonlähdeet E27 · Żarówki LED E27

| Code | Socket | Power | Lumen | Kelvin | Lifetime | Dimmable | Switch Dimmer | Switch Dim To Warm |
|---------|--------|-------|--------|---------|----------|----------|---------------|--------------------|
| 987-60 | E27 | 4,9 W | 470 lm | 3.000 K | 25.000 h | | | |
| 988-700 | E27 | 6,5 W | 560 lm | 3.000 K | 25.000 h | ✓ | | |
| 988-10 | E27 | 8,5 W | 806 lm | 3.000 K | 25.000 h | | ✓ | |
| 988-110 | E27 | 10 W | 806 lm | 3.000 K | 25.000 h | ✓ | | |



| Code | Socket | Power | Lumen | Kelvin | Lifetime | Dimmable | Switch Dimmer | Switch Dim To Warm |
|---------|--------|-------|--------|-------------------------------|----------|----------|---------------|--------------------|
| 987-909 | E27 | 9 W | 806 lm | 2.200 K 2.700 K 3.000 K | 25.000 h | | | ✓ |



| Set 2 | | Code | Socket | Power | Lumen | Kelvin | Lifetime | Dimmable | Switch Dimmer | Switch Dim To Warm |
|-------|--|---------|--------|-------|--------|---------|----------|----------|---------------|--------------------|
| Set 2 | | 987-260 | E27 | 4,9 W | 470 lm | 3.000 K | 25.000 h | | | |



| | | | | | | | | |
|--------|-----|-------|--------|---------|----------|--|--|--|
| 986-40 | E27 | 3,5 W | 470 lm | 3.000 K | 25.000 h | | | |
| 986-60 | E27 | 4,9 W | 470 lm | 3.000 K | 25.000 h | | | |

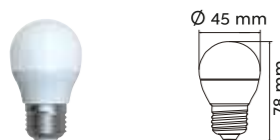

| Set 3 | | Code | Socket | Power | Lumen | Kelvin | Lifetime | Dimmable | Switch Dimmer | Switch Dim To Warm |
|-------|--|--------|--------|-------|--------|---------|----------|----------|---------------|--------------------|
| Set 3 | | 986-43 | E27 | 3,5 W | 320 lm | 3.000 K | 10.000 h | | | |
| Set 3 | | 986-63 | E27 | 5 W | 400 lm | 3.000 K | 10.000 h | | | |



| | | | | | | | | |
|----------|-----|-----|--------|---------|----------|--|---|--|
| 987-400 | E27 | 4 W | 470 lm | 2.700 K | 10.000 h | | | |
| 987-6810 | E27 | 7 W | 806 lm | 2.700 K | 10.000 h | | ✓ | |

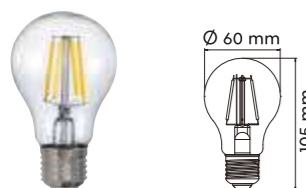

| | | | | | | | | |
|----------|-----|-----|--------|-------------------------------|----------|--|--|---|
| 987-7009 | E27 | 7 W | 806 lm | 2.200 K 2.700 K 3.000 K | 10.000 h | | | ✓ |
|----------|-----|-----|--------|-------------------------------|----------|--|--|---|

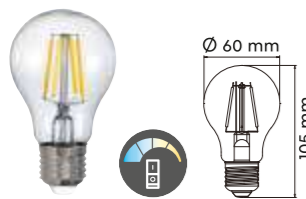

| Code | Socket | Power | Lumen | Kelvin | Lifetime | Dimmable | Switch Dimmer | Switch Dim To Warm |
|---------|--------|-------|--------|---------|----------|----------|---------------|--------------------|
| 987-740 | E27 | 7 W | 806 lm | 4.000 K | 25.000 h | | ✓ | |



| Set 2 | | Code | Socket | Power | Lumen | Kelvin | Lifetime | Dimmable | Switch Dimmer | Switch Dim To Warm |
|-------|--|----------|--------|-------|--------|---------|----------|----------|---------------|--------------------|
| Set 2 | | 987-2400 | E27 | 4 W | 470 lm | 2.700 K | 10.000 h | | | |

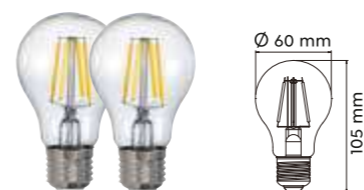

| | | | | | | | | |
|----------------|-----|-----|--------|---------|----------|--|---|--|
| 987-479 amber | E27 | 4 W | 470 lm | 2.700 K | 10.000 h | | | |
| 987-6700 amber | E27 | 7 W | 700 lm | 2.700 K | 10.000 h | | ✓ | |

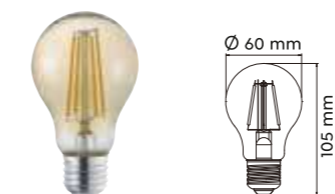

| Set 2 | | Code | Socket | Power | Lumen | Kelvin | Lifetime | Dimmable | Switch Dimmer | Switch Dim To Warm |
|-------|--|----------------|--------|-------|--------|---------|----------|----------|---------------|--------------------|
| Set 2 | | 987-2479 amber | E27 | 4 W | 470 lm | 2.700 K | 10.000 h | | | |



| Deko-Filament | | Code | Socket | Power | Lumen | Kelvin | Lifetime | Dimmable | Switch Dimmer | Switch Dim To Warm |
|---------------|--|----------------|--------|-------|--------|---------|----------|----------|---------------|--------------------|
| Deko-Filament | | 986-4813 amber | E27 | 7 W | 400 lm | 1.800 K | 25.000 h | | ✓ | |

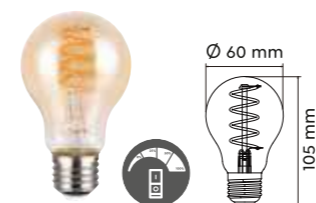

| | | | | | | | | |
|---------------|-----|-----|--------|---------|----------|--|--|--|
| 987-410 amber | E27 | 4 W | 430 lm | 2.800 K | 10.000 h | | | |
|---------------|-----|-----|--------|---------|----------|--|--|--|



LED-LEUCHTMITTEL E27

LED bulbs E27 · Ampoules LED E27 · LED-lampen E27 · Bombillas a LED E27 ·
Lampadine a LED E27 · Becuri cu LED-uri E27 · LED-Valonl hteet E27 ·  ar wki LED E27

| Code | Socket | Power | Lumen | Kelvin | Lifetime | Dimmable | Switch Dimmer | Switch Dim To Warm |
|------|--------|-------|-------|--------|----------|----------|---------------|--------------------|
|------|--------|-------|-------|--------|----------|----------|---------------|--------------------|

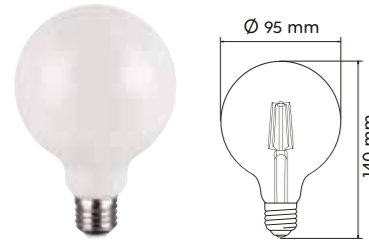

| | | | | | | | | |
|---------|-----|-----|----------|---------|----------|--|--|--|
| 988-901 | E27 | 9 W | 1.055 lm | 3.000 K | 25.000 h | | | |
|---------|-----|-----|----------|---------|----------|--|--|--|

| Code | Socket | Power | Lumen | Kelvin | Lifetime | Dimmable | Switch Dimmer | Switch Dim To Warm |
|------|--------|-------|-------|--------|----------|----------|---------------|--------------------|
|------|--------|-------|-------|--------|----------|----------|---------------|--------------------|

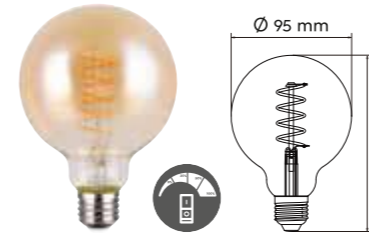

| Deko-Filament | | | | | | | | |
|---------------|-----|-----|--------|---------|----------|--|---|--|
| 988-4813 | E27 | 7 W | 400 lm | 1.800 K | 25.000 h | | ✓ | |

556

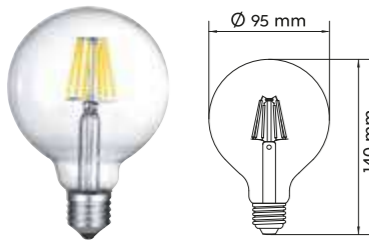

| | | | | | | | | |
|----------|-----|-----|--------|---------|----------|--|---|--|
| 988-600 | E27 | 7 W | 806 lm | 3.000 K | 10.000 h | | | |
| 985-6810 | E27 | 7 W | 806 lm | 2.700 K | 10.000 h | | ✓ | |

557

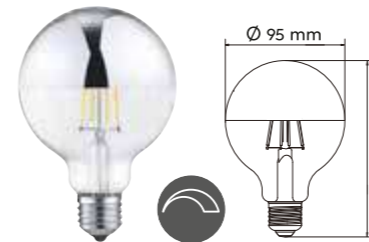

| | | | | | | | | |
|---------|-----|-----|--------|---------|----------|---|--|--|
| 988-710 | E27 | 7 W | 680 lm | 2.700 K | 10.000 h | ✓ | | |
|---------|-----|-----|--------|---------|----------|---|--|--|

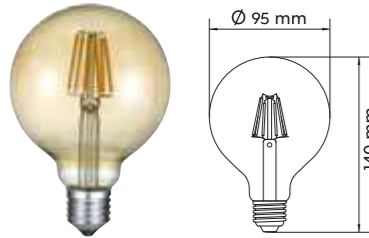

| | | | | | | | | |
|---------|-------|-----|-----|--------|---------|----------|--|--|
| 988-679 | amber | E27 | 6 W | 660 lm | 2.700 K | 10.000 h | | |
|---------|-------|-----|-----|--------|---------|----------|--|--|



| | | | | | | | | |
|---------|-----|-----|--------|---------|----------|---|--|--|
| 986-710 | E27 | 7 W | 680 lm | 2.700 K | 10.000 h | ✓ | | |
|---------|-----|-----|--------|---------|----------|---|--|--|

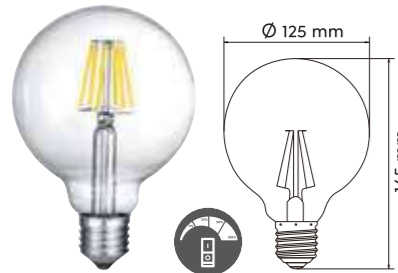

| | | | | | | | | |
|----------|-------|-----|-----|--------|---------|----------|--|---|
| 986-6810 | clear | E27 | 7 W | 806 lm | 2.700 K | 10.000 h | | ✓ |
|----------|-------|-----|-----|--------|---------|----------|--|---|



| | | | | | | | | |
|---------|-------|-----|-----|--------|---------|----------|--|--|
| 987-600 | clear | E27 | 7 W | 806 lm | 3.000 K | 10.000 h | | |
| 987-679 | amber | E27 | 6 W | 600 lm | 2.700 K | 10.000 h | | |

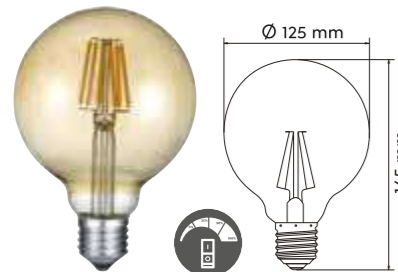

| | | | | | | | | |
|----------|-------|-----|-----|--------|---------|----------|--|---|
| 986-6790 | amber | E27 | 8 W | 806 lm | 2.700 K | 10.000 h | | ✓ |
|----------|-------|-----|-----|--------|---------|----------|--|---|

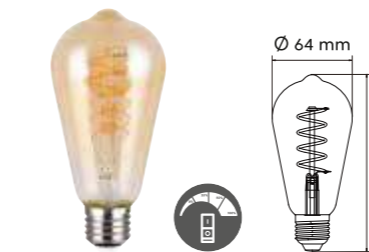

| Deko-Filament | | | | | | | | |
|---------------|-----|-----|--------|---------|----------|--|---|--|
| 987-4813 | E27 | 7 W | 500 lm | 1.800 K | 25.000 h | | ✓ | |

LED-LEUCHTMITTEL E27

LED bulbs E27 · Ampoules LED E27 · LED-lampen E27 · Bombillas a LED E27 · Lampadine a LED E27 · Becuri cu LED-uri E27 · LED-Valonlähdeet E27 · Żarówki LED E27

| Code | Socket | Power | Lumen | Kelvin | Lifetime | Dimmable | Switch Dimmer | Switch Dim To Warm |
|------|--------|-------|-------|--------|----------|----------|---------------|--------------------|
|------|--------|-------|-------|--------|----------|----------|---------------|--------------------|

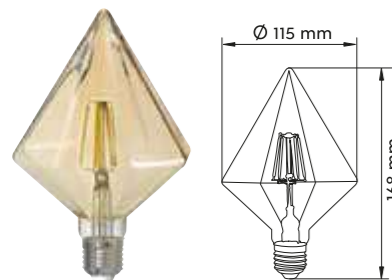

| | | | | | | | | |
|---------|-------|-----|-----|--------|---------|----------|--|--|
| 901-479 | amber | E27 | 4 W | 360 lm | 2.700 K | 25.000 h | | |
|---------|-------|-----|-----|--------|---------|----------|--|--|

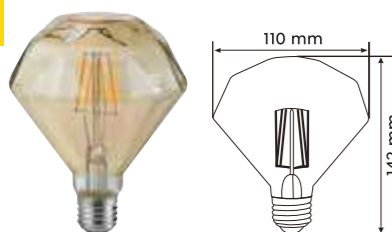

| | | | | | | | | |
|---------|-------|-----|-----|--------|---------|----------|--|--|
| 902-479 | amber | E27 | 4 W | 360 lm | 2.700 K | 25.000 h | | |
|---------|-------|-----|-----|--------|---------|----------|--|--|

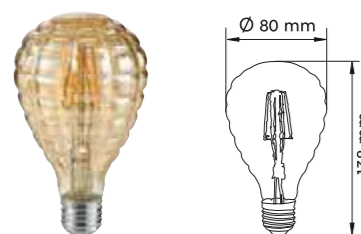

| | | | | | | | | |
|---------|-------|-----|-----|--------|---------|----------|--|--|
| 903-479 | amber | E27 | 4 W | 360 lm | 2.700 K | 25.000 h | | |
|---------|-------|-----|-----|--------|---------|----------|--|--|

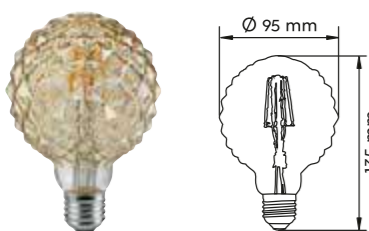

| | | | | | | | | |
|---------|-------|-----|-----|--------|---------|----------|--|--|
| 904-479 | amber | E27 | 4 W | 360 lm | 2.700 K | 25.000 h | | |
|---------|-------|-----|-----|--------|---------|----------|--|--|

LED-LEUCHTMITTEL E14

LED bulbs E14 · Ampoules LED E14 · LED-lampen E14 · Bombillas a LED E14 · Lampadine a LED E14 · Becuri cu LED-uri E14 · LED-Valonlähdeet E14 · Żarówki LED E14

| Code | Socket | Power | Lumen | Kelvin | Lifetime | Dimmable | Switch Dimmer | Switch Dim To Warm |
|------|--------|-------|-------|--------|----------|----------|---------------|--------------------|
|------|--------|-------|-------|--------|----------|----------|---------------|--------------------|

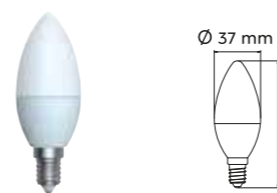

| | | | | | | | | |
|--------|-----|-------|--------|---------|----------|---|---|--|
| 989-40 | E14 | 3,5 W | 320 lm | 3.000 K | 25.000 h | | | |
| 989-56 | E14 | 4,9 W | 400 lm | 3.000 K | 25.000 h | ✓ | | |
| 989-60 | E14 | 4,9 W | 470 lm | 3.000 K | 25.000 h | | | |
| 989-66 | E14 | 4,9 W | 470 lm | 3.000 K | 25.000 h | | ✓ | |

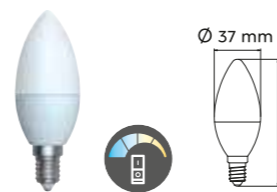

| | | | | | | | | |
|---------|-----|-------|--------|---------|----------|--|--|---|
| 989-509 | E14 | 4,9 W | 470 lm | 2.200 K | 25.000 h | | | ✓ |
| | | | | 2.700 K | | | | |
| | | | | 3.000 K | | | | |



| Set 3 | | | | | | | | |
|--------|-----|-----|--------|---------|----------|--|--|--|
| 989-43 | E14 | 4 W | 320 lm | 3.000 K | 25.000 h | | | |
| 989-63 | E14 | 6 W | 470 lm | 3.000 K | 25.000 h | | | |



| | | | | | | | | |
|--------|-----|-------|--------|---------|----------|--|--|--|
| 990-40 | E14 | 3,5 W | 320 lm | 3.000 K | 25.000 h | | | |
|--------|-----|-------|--------|---------|----------|--|--|--|

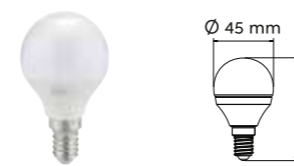

| | | | | | | | | |
|--------|-----|-------|--------|---------|----------|---|---|--|
| 983-40 | E14 | 3,5 W | 320 lm | 3.000 K | 25.000 h | | | |
| 983-56 | E14 | 4,9 W | 470 lm | 3.000 K | 25.000 h | ✓ | | |
| 983-60 | E14 | 4,9 W | 470 lm | 3.000 K | 25.000 h | | | |
| 983-66 | E14 | 4,9 W | 470 lm | 3.000 K | 25.000 h | | ✓ | |



| | | | | | | | | |
|---------|-----|-------|--------|---------|----------|--|--|---|
| 983-509 | E14 | 5,5 W | 400 lm | 2.200 K | 25.000 h | | | ✓ |
| | | | | 2.700 K | | | | |
| | | | | 3.000 K | | | | |



| Set 3 | | | | | | | | |
|--------|-----|-------|--------|---------|----------|--|--|--|
| 983-43 | E14 | 3,5 W | 320 lm | 3.000 K | 25.000 h | | | |
| 983-63 | E14 | 4,9 W | 470 lm | 3.000 K | 25.000 h | | | |

LED-LEUCHTMITTEL E14

LED bulbs E14 · Ampoules LED E14 · LED-lampen E14 · Bombillas a LED E14 · Lampadine a LED E14 · Becuri cu LED-uri E14 · LED-Valonl hteet E14 ·  ar wki LED E14

| Code | Socket | Power | Lumen | Kelvin | Lifetime | Dimmable | Switch Dimmer | Switch Dim To Warm |
|------|--------|-------|-------|--------|----------|----------|---------------|--------------------|
|------|--------|-------|-------|--------|----------|----------|---------------|--------------------|

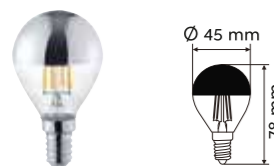

| | | | | | | | | |
|---------|-----|-----|--------|---------|----------|--|--|--|
| 983-410 | E14 | 4 W | 420 lm | 3.000 K | 10.000 h | | | |
|---------|-----|-----|--------|---------|----------|--|--|--|



| | | | | | | | | |
|---------|-------|-----|-----|--------|---------|----------|--|--|
| 989-200 | clear | E14 | 2 W | 250 lm | 2.700 K | 10.000 h | | |
| 989-279 | amber | E14 | 2 W | 225 lm | 2.700 K | 10.000 h | | |
| 989-400 | clear | E14 | 4 W | 470 lm | 2.700 K | 10.000 h | | |
| 989-479 | amber | E14 | 4 W | 400 lm | 2.700 K | 10.000 h | | |



| | | | | | | | | |
|----------|-------|-----|-----|--------|---------|----------|--|---|
| 989-4470 | clear | E14 | 4 W | 470 lm | 2.700 K | 10.000 h | | ✓ |
| 989-4790 | amber | E14 | 4 W | 400 lm | 2.700 K | 10.000 h | | ✓ |



| Set 3 | | | | | | | | |
|----------|-------|-----|-------|--------|---------|----------|--|--|
| 989-3200 | clear | E14 | 2 W | 250 lm | 2.700 K | 10.000 h | | |
| 989-3279 | amber | E14 | 2 W | 225 lm | 2.700 K | 10.000 h | | |
| 989-3400 | clear | E14 | 4,5 W | 470 lm | 2.700 K | 10.000 h | | |

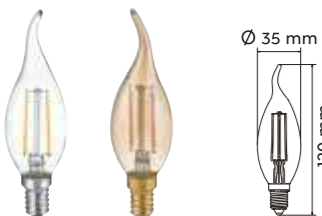

| | | | | | | | | |
|---------|-------|-----|-----|--------|---------|----------|--|--|
| 990-200 | clear | E14 | 2 W | 250 lm | 2.700 K | 10.000 h | | |
| 990-279 | amber | E14 | 2 W | 225 lm | 2.700 K | 10.000 h | | |
| 990-400 | clear | E14 | 4 W | 470 lm | 3.000 K | 10.000 h | | |

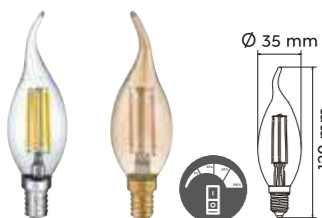

| | | | | | | | | |
|----------|-------|-----|-----|--------|---------|----------|--|---|
| 990-4470 | clear | E14 | 4 W | 470 lm | 2.700 K | 10.000 h | | ✓ |
| 990-4790 | amber | E14 | 4 W | 400 lm | 2.700 K | 10.000 h | | ✓ |



| | | | | | | | | |
|---------|-------|-----|-----|--------|---------|----------|--|--|
| 983-200 | clear | E14 | 2 W | 250 lm | 2.700 K | 10.000 h | | |
| 983-279 | amber | E14 | 2 W | 225 lm | 2.700 K | 10.000 h | | |
| 983-400 | clear | E14 | 4 W | 470 lm | 2.700 K | 10.000 h | | |
| 983-479 | amber | E14 | 4 W | 430 lm | 2.700 K | 10.000 h | | |

| Code | Socket | Power | Lumen | Kelvin | Lifetime | Dimmable | Switch Dimmer | Switch Dim To Warm |
|------|--------|-------|-------|--------|----------|----------|---------------|--------------------|
|------|--------|-------|-------|--------|----------|----------|---------------|--------------------|



| | | | | | | | | |
|----------|-------|-----|-------|--------|---------|----------|--|---|
| 983-4470 | clear | E14 | 4,5 W | 470 lm | 2.700 K | 10.000 h | | ✓ |
| 983-4790 | amber | E14 | 4 W | 400 lm | 2.700 K | 10.000 h | | ✓ |



| | | | | | | | | |
|----------|-------|-----|-------|--------|---------|----------|--|--|
| 983-3200 | clear | E14 | 2 W | 250 lm | 2.700 K | 10.000 h | | |
| 983-3279 | amber | E14 | 2 W | 225 lm | 2.700 K | 10.000 h | | |
| 983-3400 | clear | E14 | 4,5 W | 470 lm | 2.700 K | 10.000 h | | |



| | | | | | | | | |
|---------|-----|-----|--------|---------|----------|--|--|--|
| 983-440 | E14 | 4 W | 500 lm | 4.000 K | 25.000 h | | | |
|---------|-----|-----|--------|---------|----------|--|--|--|







| Deko-Filament | | | | | | | | |
|---------------|-----|-----|--------|---------|----------|--|--|--|
| 983-4813 | E14 | 4 W | 180 lm | 1.800 K | 25.000 h | | | |







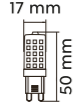



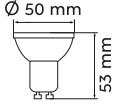

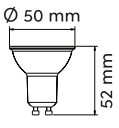
| | | | | | | | | |
|--------|--------|-----|-----|--------|---------|----------|--|--|
| 955-55 | ∠ 110° | E14 | 5 W | 400 lm | 3.000 K | 25.000 h | | |
|--------|--------|-----|-----|--------|---------|----------|--|--|

LED-LEUCHTMITTEL G9

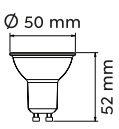

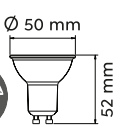

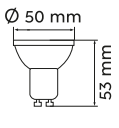
LED bulbs G9 · Ampoules LED G9 · LED-lampen G9 · Bombillas a LED G9 · Lampadine a LED G9 · Becuri cu LED-uri G9 · LED-Valonlähdeet G9 · Żarówki LED G9

| Code | Socket | Power | Lumen | Kelvin | Lifetime | Dimmable | Switch Dimmer | Switch Dim To Warm |
|---|--------|-------|--------|---------|----------|----------|---------------|--------------------|
|   | | | | | | | | |
| Set 2 | | | | | | | | |
| 929-220 | G9 | 2,3 W | 200 lm | 3.000 K | 25.000 h | | | |
|   | | | | | | | | |
| Set 2 | | | | | | | | |
| 929-2300 | G9 | 3 W | 300 lm | 3.000 K | 25.000 h | ✓ | | |
|   | | | | | | | | |
| Set 2 | | | | | | | | |
| 929-230 | G9 | 3 W | 300 lm | 3.000 K | 25.000 h | | ✓ | |

| Code | Socket | Power | Lumen | Kelvin | Lifetime | Dimmable | Switch Dimmer | Switch Dim To Warm |
|---|--------|-------|--------|-------------------------------|----------|----------|---------------|--------------------|
|   | | | | | | | | |
| 955-50 | GU10 | 4,9 W | 430 lm | 3.000 K | 25.000 h | | | |
|   | | | | | | | | |
| 956-5936 | GU10 | 4,5 W | 345 lm | 3.000 K | 20.000 h | ✓ | | |
|   | | | | | | | | |
| 956-5736 | GU10 | 4,5 W | 345 lm | 3.000 K | 20.000 h | | ✓ | |
|   | | | | | | | | |
| 956-55 | GU10 | 4,5 W | 345 lm | 3.000 K | 25.000 h | | ✓ | |
|   | | | | | | | | |
| Set 3 | | | | | | | | |
| 956-355 | GU10 | 4,5 W | 345 lm | 3.000 K | 25.000 h | | ✓ | |
|   | | | | | | | | |
| 956-509 | GU10 | 4,5 W | 345 lm | 2.200 K 2.700 K 3.000 K | 25.000 h | | | ✓ |

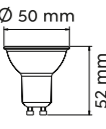
LED-LEUCHTMITTEL GU10

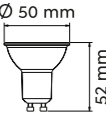
LED bulbs GU10 · Ampoules LED GU10 · LED-lampen GU10 · Bombillas a LED GU10 · Lampadine a LED GU10 · Becuri cu LED-uri GU10 · LED-Valonlähdeet GU10 · Żarówki LED GU10

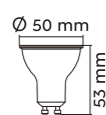
| Code | Socket | Power | Lumen | Kelvin | Lifetime | Dimmable | Switch Dimmer | Switch Dim To Warm |
|---|--------|-------|--------|---------|----------|----------|---------------|--------------------|
|   | | | | | | | | |
| 956-30 | GU10 | 3 W | 230 lm | 3.000 K | 20.000 h | | | |
|   | | | | | | | | |
| Set 3 | | | | | | | | |
| 956-330 | GU10 | 3 W | 230 lm | 3.000 K | 15.000 h | | | |
|   | | | | | | | | |
| 956-44 | GU10 | 4,5 W | 400 lm | 4.000 K | 25.000 h | | ✓ | |



Stufenlos dimmbar mit herkömmlichem Lichtregler.
Continuously dimmable with conventional light controller.

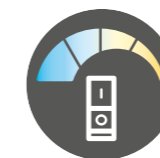

Switch Dim to Warm
Helligkeit und Lichtfarbe in 3 Stufen mit herkömmlichem Lichtschalter einstellbar.
Brightness and light colour adjustable in 3 levels with conventional light switch.

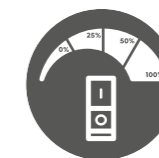

Switch Dimmer
Helligkeit in 3 Stufen mit herkömmlichem Lichtschalter einstellbar.
Brightness adjustable in 3 levels with conventional light switch.

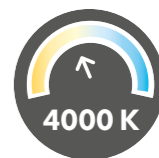

Die Lichtfarbe dieser Leuchte beträgt 4.000 Kelvin (K). Die Wirkung wird als neutralweiß beschrieben.
The light color of this lamp is 4,000 Kelvin (K). The effect is described as neutral white.

POS-LÖSUNGEN

POS solutions · Solutions de POS · POS-oplossingen ·
Soluciones POS · Soluzioni POS · Soluții POS · POS-ratkaisut · Rozwiązania POS

LME 100-240
Tego-Regale · Tego shelves
Leuchtmittel · light sources

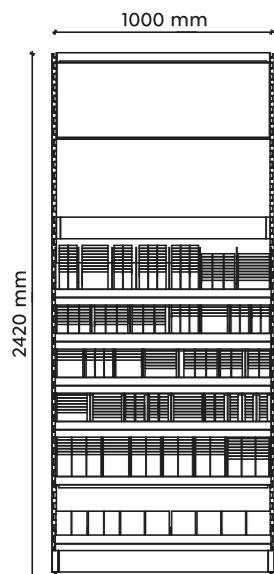
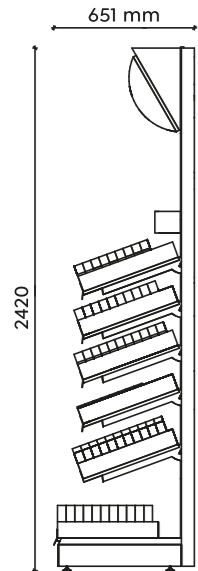

Display RK 51-B
Leuchtmittel · light sources

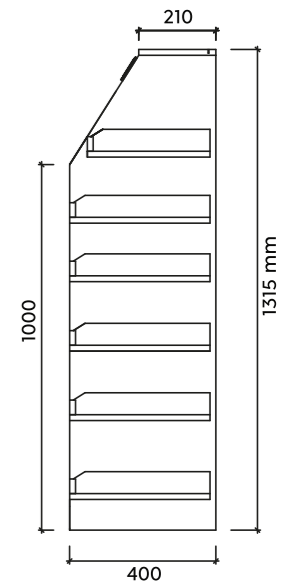
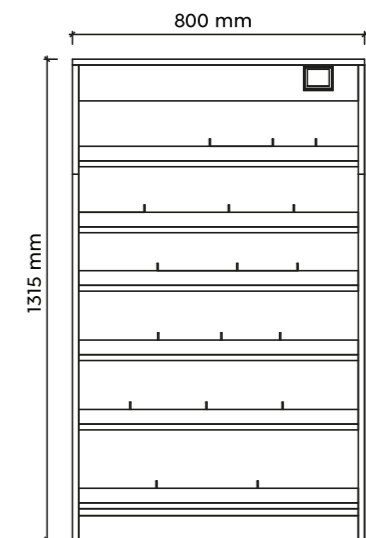

POS-LÖSUNGEN

POS solutions · Solutions de POS · POS-oplossingen ·
Soluciones POS · Soluzioni POS · Soluții POS · POS-ratkaisut · Rozwiązania POS



Display **RK 58**
Deckenleuchten · Ceiling lamps

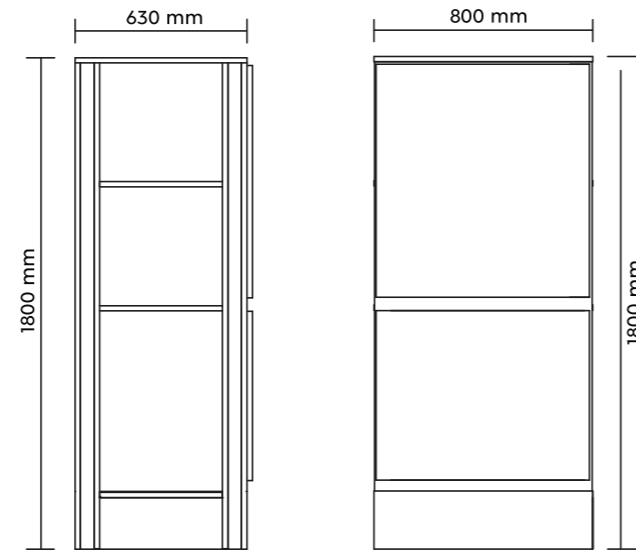

Display **RK 106**
Spots · Spots

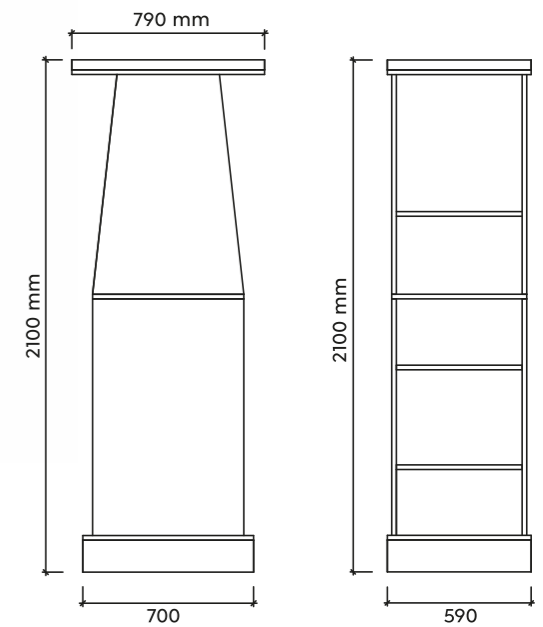

Display **RK 75**
Deckenleuchten · Ceiling lamps

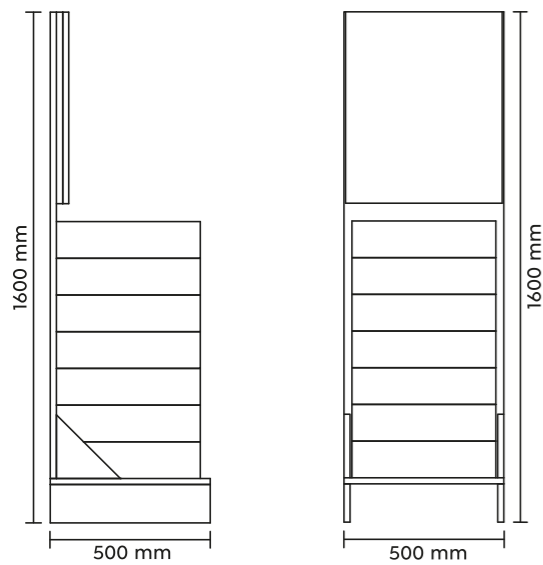

POS-LÖSUNGEN

POS solutions · Solutions de POS · POS-oplossingen ·
Soluciones POS · Soluzioni POS · Soluții POS · POS-ratkaisut · Rozwiązania POS



Tego-Regale · Tego shelves
Schienensystem · track system



Display DUO 01
Schienensystem · track system

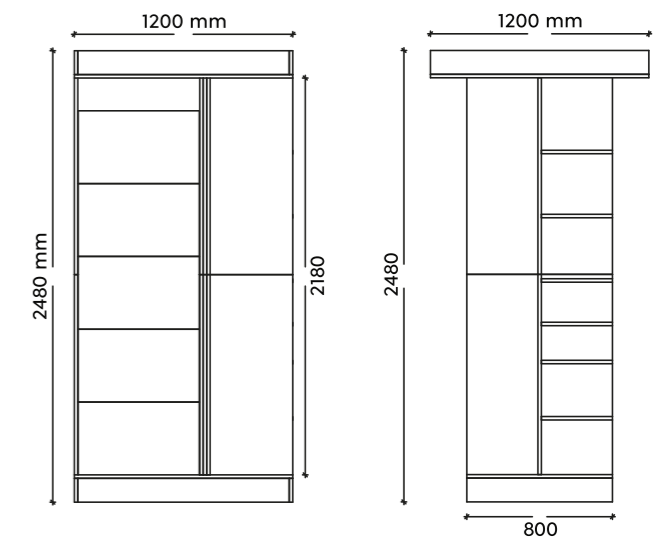
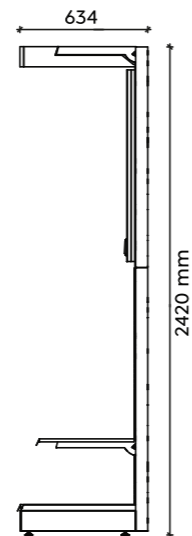
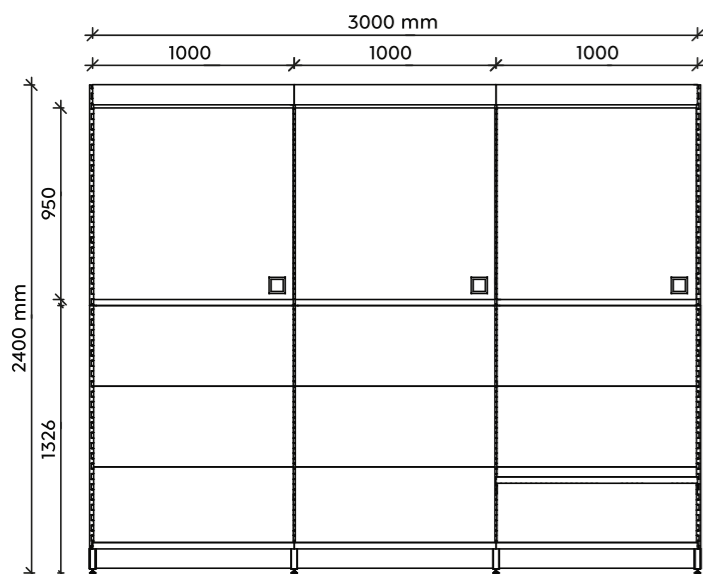

POS-LÖSUNGEN

POS solutions · Solutions de POS · POS-oplossingen ·
Soluciones POS · Soluzioni POS · Soluții POS · POS-ratkaisut · Rozwiązania POS

Tego-Regale · Tego shelves
Einbauleuchten · recessed lights

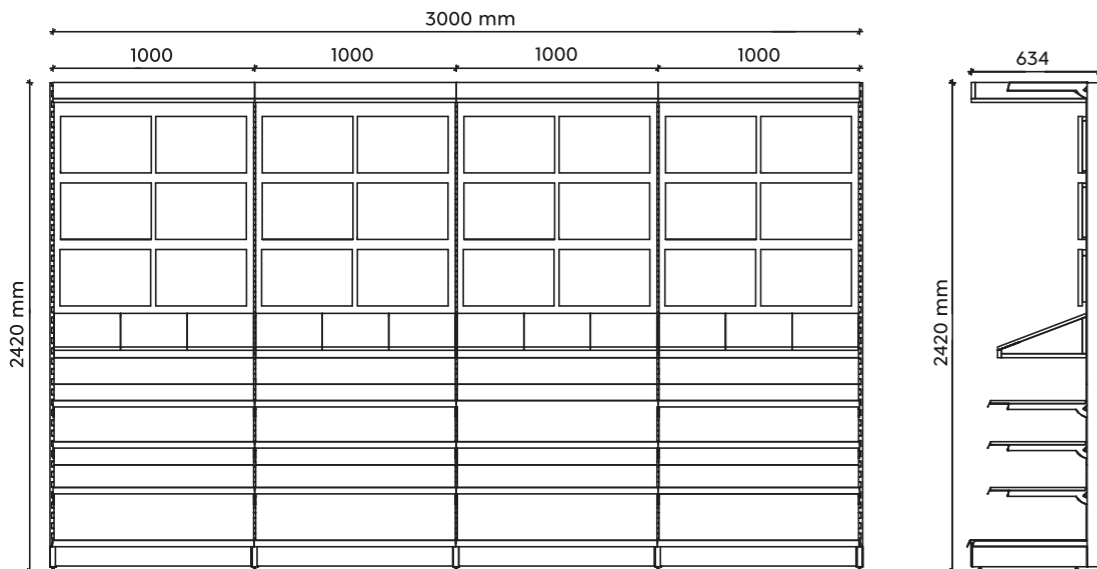
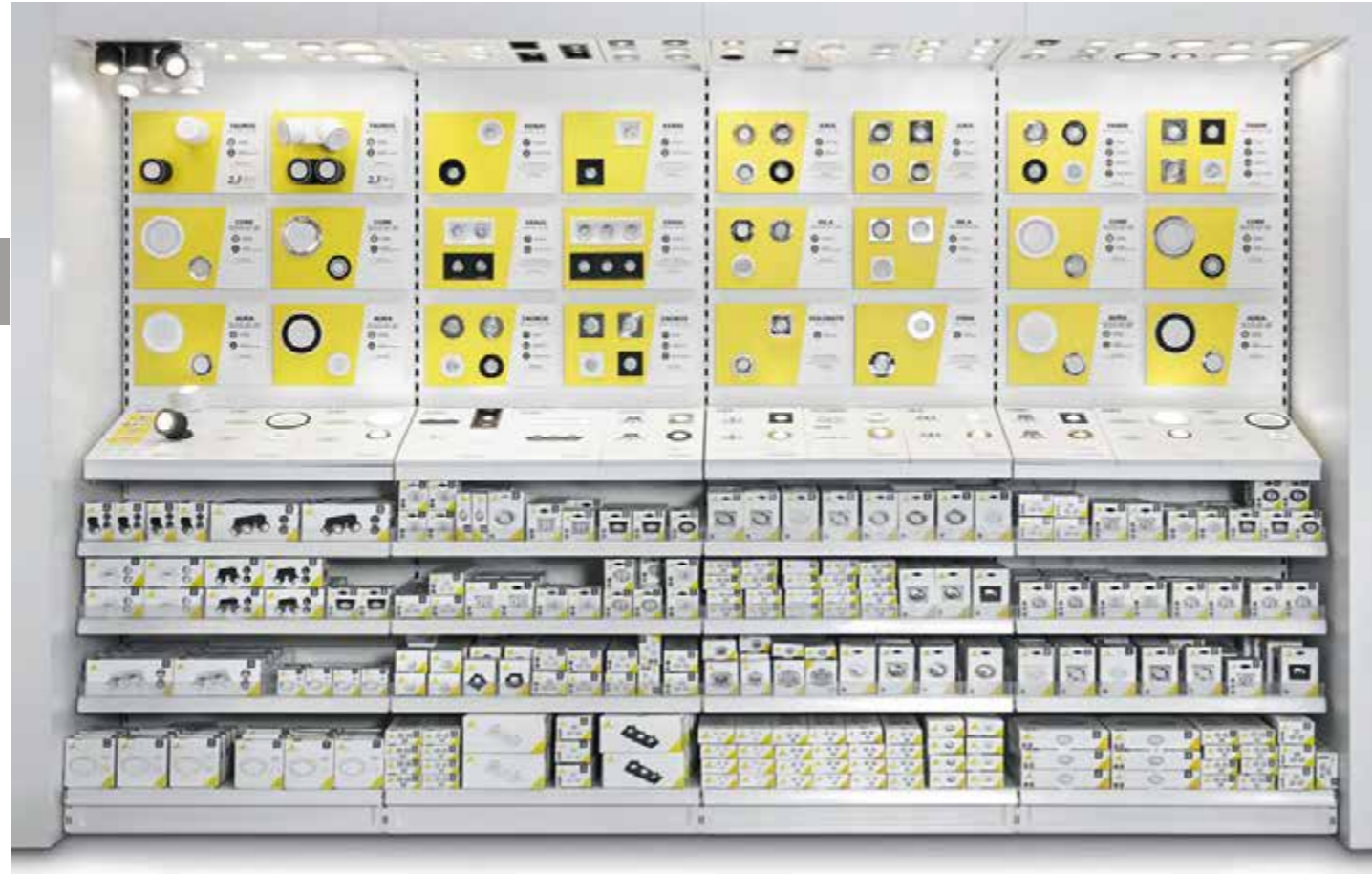

Display RK 63
Einbauleuchten · recessed lights

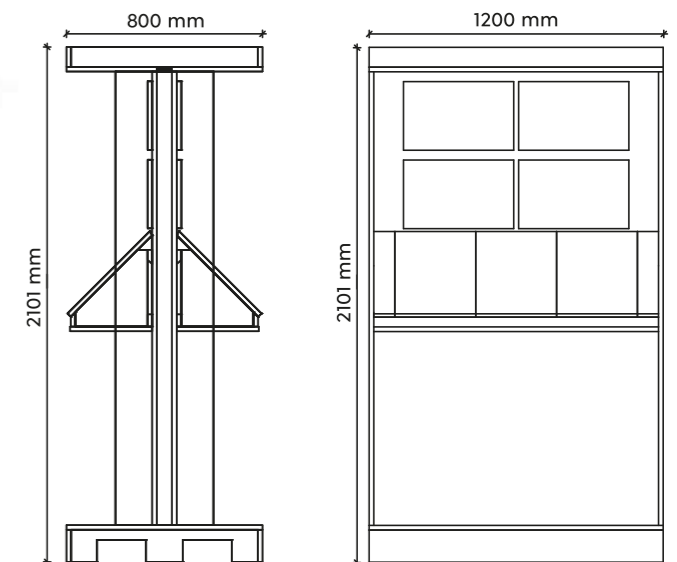

POS-LÖSUNGEN

POS solutions · Solutions de POS · POS-oplossingen ·
Soluciones POS · Soluzioni POS · Soluții POS · POS-ratkaisut · Rozwiązania POS



Tego-Regale · Tego shelves
Badezimmerleuchten · bathroom lighting

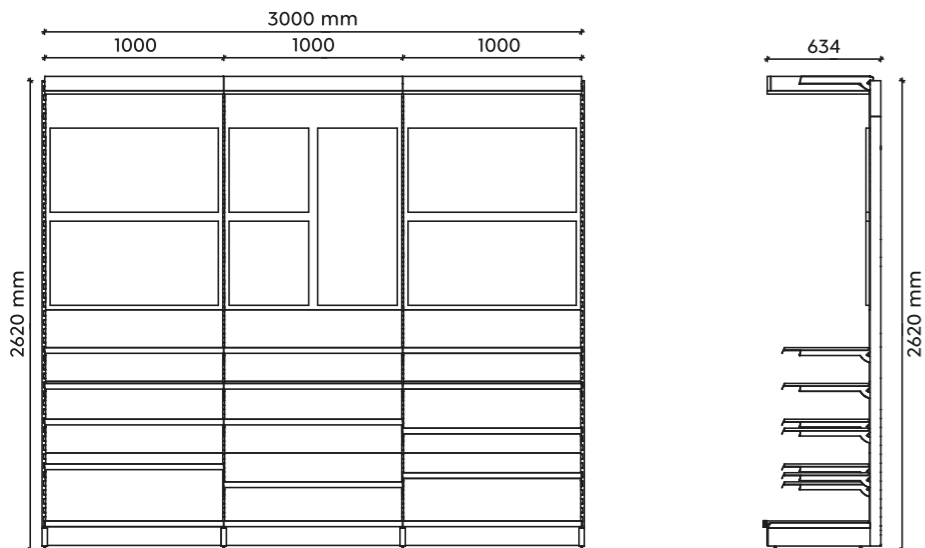

Display RK 99
Badezimmerleuchten · bathroom lighting

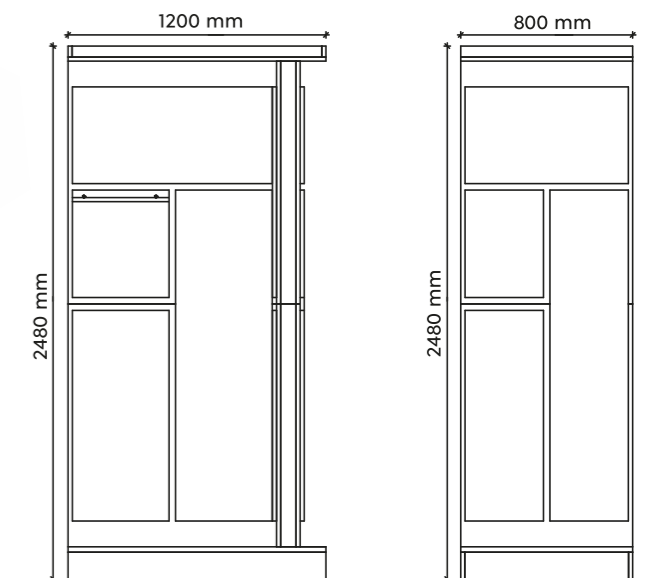

572

573



Spezifikationen

Specifications
Spécifications
Specificaties
Especificaciones
Specifiche
Specificații
Tekniset tiedot
Specyfikacje

FARBEN & MATERIALIEN

Colours and materials · Couleurs et matériaux · Kleuren en materialen · Colores y materiales · Colori e materiali · Colori si materiale · Värit ja materiaalit · Kolory i materiały · Renkler ve malzemeler

- 00** Transparent · transparent
transparent · transparant · transparente · transparente · transparent · kirkas · przezroczysty · şeffaf
- 01** Weiß · white
blanc · wit · blanco · bianco · alb · valkoinen · biały · beyaz
- 02** Schwarz · black
noir · zwart · negro · nero · negru · musta · czarny · siyah
- 03** Messing poliert · polished brass
laiton polis · gepolijst messing · bronce · ottone lucido · bronz · messinki · mosiądz polerowany · piringç
- 04** Altmessing · old brass
laiton fumé · oud brons · bronce viejo · ottone invecchiato · bronz antic · antiikkimessinki · patyna · antik piringç
- 05** Aluminium gebürstet · brushed aluminium
aluminium balayé · geborsteld aluminium · aluminio pulido · alluminio spazzolato · aluminiu lucios · harjattu alumiini · aluminium szczotkowane · alüminyum
- 06** Chrom · chrome
chrome · chroom · cromo · cromo · crom · kromi · chrom · krom
- 07** Nickel matt · nickel mat
nickel mat · nikkel mat · níquel mate · nichel opaco · nichel mat · harjattu teräs · nikiel mat · mat nikel
- 08** Messing matt · brass mat
laiton mat · messing mat · bronce mate · ottone satinato · bronz mat · mattamessinki · mosiądz mat · mat piringç
- 09** kupferfarbig · copper
cuivré · koperkleurig · color cobre · colore rame · cupru · kuperinvärinen · kolorze miedzi · bakir renkli
- 10** Rot · red
rouge · rood · rojo · rosso · rosu · punainen · czerwony · kırmızı
- 11** Grau · grey
gris · grijs · gris · grigio · gri · harmaa · popielaty · gri
- 12** Blau · blue
bleu · blauw · azul · azzurro · gri · sininen · niebieski · mavi
- 13** Amber · amber
ambre · amber · ámbar · ambra · amber · meripihka · bursztynowy · amber
- 14** Braun · brown
brun · bruin · marron · marrone · maro · ruskea · brązowy · kahverengi
- 15** Grün · green
vert · groen · verde · verde · verde · vihreä · zielony · yeşil
- 16** Gelb · yellow
jaune · geel · amarillo · giallo · galben · keltainen · żółty · sarı
- 17** mehrfarbig · multicolor
multicolore · multicolor · multicolor · multicolore · multicolor · monivärinen · multi-kolor · çok renkli

- 18** Orange · orange
orange · oranje · naranja · arancione · portocaliu · oranssi · pomarańczowy · turuncu
- 19** Türkis · turquoise
turquoise · turquoise · turquesa · turchese · turcoaz · turkoosi · turkusowy · turkuvaz
- 24** rostfarbig · rusty
rouille · roestkleur · óxido · ruggine · ruginiu · rustiikki · miedź · pas
- 26** Braun · brown
brun · bruin · marron · marrone · maro · ruskea · brązowy · kahverengi
- 27** Weiß antik · antique white
blanc antique · antiek wit · blanco decapé · bianco anticato · alb antic · antiikkivalkoinen · antyczny biały · antik beyaz
- 28** rostfarbig antik · antique rust
rouille antique · roestkleur antiek · oxido · ruggine anticato · ruginiu antic · rustiikki · antyczny rdzawy · antik pas rengi
- 29** Kupfer matt · copper mat
cuivre mat · koper mat · estera de cobre · rame opaco · cupru mat · kupari mat · miedź mat · bakir mat
- 30** holzfarbig · wood coloured
couleur bois · houtkleur · color mader · colore di legno · culoare lemn · puunvärinen · kolor drewna · ahşap renk
- 31** Weiß matt · white mat
blanc mat · wit mat · estera blanca · blanco opaco · alb mat · valkoinen matto · biały mat · beyaz mat
- 32** Schwarz matt · black mat
noir mat · mat zwart · estera negra · nero opaco · negru mat · musta matto · czarny mat · siyah mat
- 34** Schwarz-Weiß · black and white
noir et blanc · zwart en wit · blanco y negro · nero e bianco · negru și alb · mustavalkoinen · biały i czarny
- 41** Taupe · taupe
taupe · taupe · gris pardo · taupe · taupe · ruskeanharmaa · ciemnoszary · taupe
- 42** Anthrazit · anthracite
antracite · antraciet · antracita · antracite · antracit · antrasiitti · antracyt · antrasit
- 45** Pastellblau · pastel blue ·
bleu pastel · pastel blauw · azul pastel · azzurro pastello · albastru pastel · pastellinsininen · pastelowy niebieski · pastel mavi
- 49** Pistaziengrün · pistachio green
vert pistache · pistachegroen · verde pistacho · verde pistacchio · verde fistic · pistaasin vihreä · zielony pistacjowy
- 51** Apfelgrün · applegreen
vert pomme · appelgroen · verde manzana · verde mela · verde mar · omenanvihreä · zielone jabłko · elma yeşili
- 52** Transparent klar · transparent clear
transparent claire · transparant helder · transparente claro · transparente chiaro · transparent clar · kirkas · przezroczysty · şeffaf

- 54** rauchfarbig · smoke
fumé · rookkleur · humo · fume' · fumuriu · savu · przydymiony · duman
- 56** Holz dunkel · old wood
vieux bois · oud hout · mader · envejecida · legno antico · old wood (Lemn vechi) · vanha puu · stare drewno
- 57** Chrom bedampft · chrome plated
chromé · verchroomd · acero cromado · cromato · cromat · kromattu · chromowany
- 61** Grau antik · antique grey
gris ancien · antiek grijs · gris antiguo · grigio antico · antic gri · antiikki harmaa · starodawny szary · antika gri
- 62** Kupfer antik · antique copper
cuivre ancien · antiek koper · cobre antiguo · rame antico · cupru antic · antiikki kupari · antyczne miedzi · antik bakir
- 64** Bronze · bronze
bronze · bronze · bronce · bronzo · bronz · pronssi · brąz · tunç
- 65** Coffee · coffee
café · koffie · café · caffè · cafea · antiikkiteräs · kawa
- 67** Nickel antik · nickel antique
nickel antique · antiek nikkel · níquel antiguo · nickel anticato · nichel antic · antiikkiteräs · aikiel antyczny · antik nikel
- 77** Ultimate Grau · ultimate grey
gris ultimate · ulziem grijs · gris absoluto · grigio assoluto · gri suprem · kultaa · ciemnoszary
- 78** betonfarbig · concrete look
couleur beton · beton kleur · color concreto · calcestruzzo · culoare beton · konkreettisia väri · konkretny kolor · beton rengi

- 79** goldfarbig · gold
or · goud · oro · oro · aur · kultaa · złota · altın
- 80** Schwarz-Gold · black-gold
noir et or · zwart-goud · negro-oro · oro nero · negru-auriu · musta-kulta · czarno złoty
- 83** Illuminate Gelb · illuminate yellow
jaune illuminate · helder geel · amarillo iluminado · giallo brillante · galben strălucitor · titaani · świetlisty żółty
- 87** titanfarbig · titan
titane · titaan · titán · titano · titaniu · titaani · tytanowy · titan
- 88** Silber antik · antique silver
argent antique · antiek zilver · plateado antiquo · argento anticato · argint antic · antiikkiihopea · antyczne srebro · gümüş antika
- 89** silberfarbig · silver
argent · zilver · plata · argento · argint · hopea · srebrny · gümüş
- 91** Lila · lilac
lilla · lilla · lila · lilla · lila · lila · liliowy · leylak
- 92** Purpurrot · purple
pourpre · paars · púrpura · porpora · purpuriu · purppura · purpurowy · mor
- 93** Pink · pink
rose · pink · rosa · rosa · roz · pinkki · różowy · pembe
- 94** Pastellrosa · pastel pink ·
rose pastel · pastel rose · rosa pastel · rosa pastello · roz pastel · pastellin pinkki · pastelowy róż · pastel pembe

PRODUKTEIGENSCHAFTEN

Features · Caractéristiques · Kenmerken · Acabados · Caratteristiche · Caracteristici · Ominaisuudet · Čechy



Schalter · Switch
Interrupteur · Schakelaar · Interruptor · Interruttore · Intrerupator · Kytkin · Przełącznik



Fußschalter · Footswitch
interrupteur à pédale · Voetschakelaar · Interruptor de pie · interruttore a pedale · comutator picior · Päälle / pois jalkakytin · wyłącznik nożny



Schnurschalter · Cable switch
Interrupteur de cordon · Snoerschakelaar · Cable de interruptor · Interruttore su cavo · Intrerupator cu cablu · katkaisin ja johto · Przełącznik na kablu



On/Off Touch Funktion · On/Off Touch function
Interrupteur tactile On/Off · Touch schakelaar On/Off · Función táctil On/Off · Interruttore touch On/Off · Intrerupator tactil On/Off · Kosketuskäyttöinen On/Off · Funkcja dotykowa On/Off



Getrennt schaltbar · Separately switchable
Interrupteurs séparés · Gescheiden schakelbaar · Interruptores separados · Interruttori separati · Intrerupatoare separate · Erikseen kytkettävissä · Oddzileny przełącznik



Fernbedienung · Remote control
Commande à distance · Afstandsbediening · Mando a distancia · Comando a distanza · Telecomanda · Kauko-ohjain · Pilot



Integrierter Dimmer · Integrated dimmer
Variateur intégré · Geïntegreerde dimmer · Regulador integrado · Dimmer integrato · Variator de lumina integrat · Integroitu himmennin · Wbudowany ściemniacz



Zugschalter · Pull switch
Interrupteur de trait · Trekschakelaar · Interruptor de tiro · Interruttore con tirata · Interupator de tragere · Vetokytin · Przełącznik pociągany



Sensordimmer · Sensor dimmer
Variateur tactile · Touchdimmer · Regulador con sensor · Touchdimmer · Variator cu senzor · Kosketushimmennin · Czujnik ściemniania



Extern dimmbar · Externally dimmable
Dimmable avec variateur externe · Extern dimbaar · Dimmable por regulador externo · Dimmerabile con dimmer esterno · variator extern de lumina · himmennettävissä · Zewnętrznie ściemniania



RGB Farbwechsler · RGB Colorchanging
Changement de couleur RGB · RGB Kleurverandering · Cambio de color RGB · Cambia colore RGB · Schimbator de culoare RGB · Värinvaihto RGB · Zmieniający kolor RGB



Lichtfarbe einstellbar · Adjustable light color
Couleur de lumière réglable · Lichtkleur instelbaar · Color de luz regulable · Colore della luce regolabile · Lumina colorata reglabila · Värilämpötila säädettävissä · Regulowana barwa światła



Höhenverstellbar · Adjustable height
Hauteur réglable · In hoogte verstelbaar · Altura regulable · Altezza regolabile · Inaltime reglabila · Säädettävä korkeus · Regulowana wysokość



Schwenkbar · Tilttable
Pivotant · Draaibaar · Pivotante · Girevole · Pivotant · Suunnattava · Skråtning



Steckdose · Plug
Prise · Stekker · Enchufe · Spina · Priza · Katkaisin · Gniazdko



Vergrößerung 3x · Magnification 3x
Magnification 3x · Vergroting 3x · Aumentos 3x · Ingrandimento 3x · Suplimentare 3x · Suurentava 3x · Powiększenie 3x



4 fach TOUCH · 4 level Touch function
Interrupteur tactile 4 niveaux · Touch schakelaar 4 niveaus · Función Táctil 4 nivel · Interruttore touch 4 livelli · Intrerupator tactil 4 nivele · Kosketuskäyttöinen 4 taso · Funkcja dotykowa 4 poziomy



Flexibel · Flexible
Flexible · Flexibel · Flexible · Flessibile · Flexibil · Joustava · Elastyczne



Kippbar · Tilttable
Inclinable · Kantelbaar · Basculante · Inclinabile · Basculant · Kallistettava · Uchylny



Lichtfarbe stufenlos einstellbar · Light color infinitely variable
Couleur de lumière infiniment variable · Lichtkleur traploos instelbaar · Color de luz infinitamente variable · Colore della luce infinitamente variabile · Culoare lumină infinit variabilă · Valon väri portaattomasti · Jasny kolor bezstopniowo



USB Anschluss · USB connection
Entrée USB · USB aansluiting · Conexión USB · Connessione USB · Conexiune USB · USB-liitäntä · Połączenie USB



USB Anschluss mit Ladefunktion · Recharging USB connection
Entrée USB de rechargement · Opladende USB aansluiting · Conexión USB de recarga · Connessione USB di ricarica · Conexiune USB reîncărcare · Lataaminen USB-liitäntä · ładowania USB połączenie



Nachtlicht · Night light
Veilleuse de nuit · Nachlicht · Luz de la noche · Luce notturna · Lampă de noapte · Yyövalo · Lampka nocna



Gestensteuerung · Gesture control
Contrôle gestuel · Gebarenbediening · Control gestual · Controllo gestuale · Control prin gesturi/mișcarea mâinii · Kädelä ohjattava liiketunnistin · Sterowana gestami



Up and down Beleuchtung · Up and Down lighting
Point lumineux en haut et en bas · Lichtpunt boven en onder · Luz de arriba y abajo · Luce su e giù · Sus și în jos lumina · Ylös ja alas valoa · W górę iw dół światło



Dimmbar mit Schalter · Dimmable via switch
Réglable avec interrupteur · Dimbaar via schakelaar · Regulable mediante interruptor · Dimmerabile tramite interruttore · Estompat prin comutator · Himmennettävä kytkimen · Ściemnialne za pośrednictwem przełącznika



Musterschutz · Registered model
Modèle déposé · Beschermd model · Modelo certificado · Modello depositato · Înregistrat model · Reķisteröity malli · Zarejestrowany wzór



Starlight Effekt · Starlight effect
Effet étoiles · Starlight effekt · Efecto estrella · Effetto stelle · Efect de "stele" · Tähti efekti · Effekt starlight



RGBW Farbwechsler · RGBW Colorchanging
Changement de couleur RGBW · RGBW Kleurverandering · Cambio de color RGBW · Cambia colore RGBW · Schimbator de culoare RGBW · Värinvaihto RGBW · Zmieniający kolor RGBW



Ohne Leuchtmittel · Lamp(s) excluded
Sans ampoule(s) · Zonder lichtbron(nen) · Sin bombilla(s) · Lampadina Esclusa · Fara bec (s) · Ilman polttimo (s) · Bez żarówki (s)



LIFT ME
Innovative Höhenverstellung ohne Gegengewicht · Innovative height adjustment without counterweight · Nouveau! Réglage de la hauteur sans contrepoids · Innovatieve hoogterstelling zonder contragewicht · Innovador sistema de ajuste de altura sin necesidad de contrapeso · Regolazione innovativa dell'altezza senza contrappeso · Ajustare inovativa a inaltime fara contragreutate · Innovatiivinen korkeuden säätö ilman vastapainoa · Innowacyjna regulacja wysokości bez przeciwwagi



SWITCH DIM TO WARM
Lichtfarbe mit Schalter einstellbar · Light color adjustable with switch
Couleur de lumière réglable avec interrupteur · Lichtkleur instelbaar met schakelaar · Color de la luz ajustable con interruptor · Colore della luce regolabile con interruttore · Culoarea luminii reglabila cu un comutator · Valon väri säädettävällä kytkimellä · Kolor światła regulowane z przełącznikiem



Ausziehbar · Extendible
extensible · Verlengbaar · Extensibile · Estensibile · extensibila · Jatkettava · Rozsuwalny



Memory Funktion · Memory function
fonction mémoire · Geheugen functie · Función de memoria · Funzione memorizzazione · functia memorie · Muistitoiminto · Funkcja pamięci



indirekte Beleuchtung · indirect lighting
lumière indirecte · indirecte belichting · Iluminación indirecta · Illuminazione a scomparsa · iluminat indirect · epäsuora valaistus · oświetlenie pośrednie



DIP SWITCH
Lichtfarben direkt an der Leuchte einstellbar · Colours directly adjustable at the lamp
Les couleurs de la lumière peuvent être réglées directement sur le luminaire · Lichtkleuren direct instelbaar op de lamp · Tonalidades de luz ajustables directamente en la lámpara · Colori della luce regolabili direttamente sulla lampada · Colori ale luminii reglabile direct de la bec · Valon väri asetettavissa suoraan valaisimesta · Barwy światła można ustawić bezpośrednio na oprawie



DIP SWITCH

Mittels DIP SWITCH können 3 Lichtfarben (warmweiß, neutralweiß und kaltweiß) über einen Schalter direkt an der Leuchte eingestellt werden.

The DIP SWITCH directly sets the luminaire's three light colours (warm, neutral and cool white).



Warmweiß | Warm white



Neutralweiß | Neutral white



Kaltweiß | Cool white

LED SWITCH DIMMER

DIMMEN OHNE DIMMER | DIMMING WITHOUT DIMMER

Helligkeit bequem mit jedem herkömmlichen Lichtschalter einstellbar.

Adjusting the desired level of brightness with any conventional light switch.

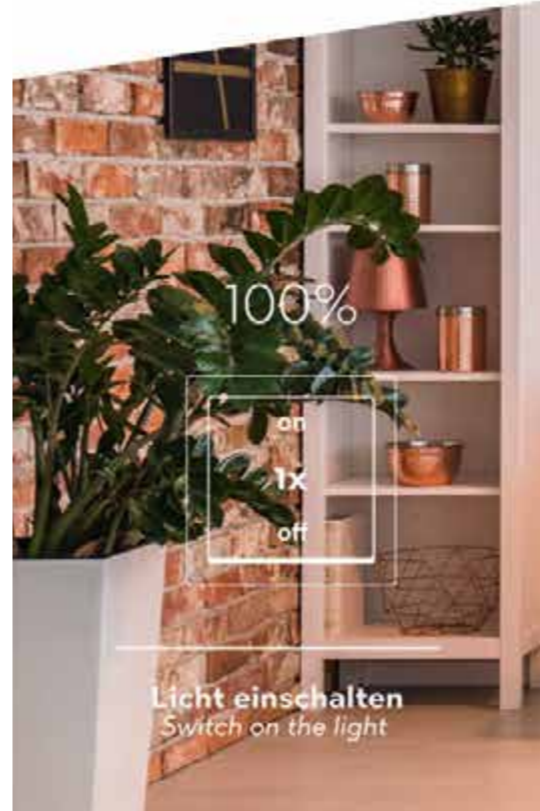

Licht einschalten
Switch on the light

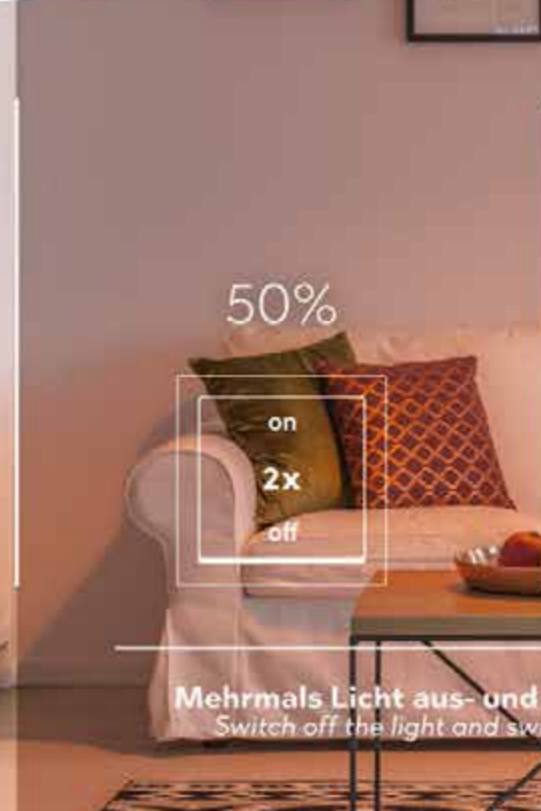

Mehrmals Licht aus- und sofort wieder einschalten
Switch off the light and switch it immediately on again



^(D) Diese Wandleuchte ist sowohl für den Festanschluss, als auch für den Betrieb mit Steckerzuleitung geeignet.

^(NL) Deze wandlamp is zowel geschikt voor een vaste stroomaansluiting als voor het aansluiten van een plug-in voedingskabel.

^(RO) Această aplica este potrivită atât pentru a fi montată direct la sursa de curent, dar și pentru a fi conectată printr-un cablu de curent la priză.

^(GB) This wall light is suitable both for a fixed power connection, as well as for the connection of a plug-in power cable.

^(ES) Esta luz de pared es adecuada tanto para una conexión de alimentación fija como para la conexión por cable de alimentación.

^(FI) Tämä seinävalaisin voidaan asentaa kiinteästi kytkentäriman avulla tai käyttämällä mukana tulevaa liitosjohtoa.

^(FR) Cette applique convient à la fois pour une connexion d'alimentation fixe, ainsi que pour la connexion d'un câble d'alimentation enfichable.

^(IT) Questa lampada da parete è adatta sia per una connessione di alimentazione fissa, sia per la connessione di un cavo di alimentazione plug-in.

^(PL) Ta lampa ścienna jest odpowiednia zarówno do podłączenia na stałe, jak również do eksploatacji przy użyciu przewodu z wtyczką.

DIGITAL AN IHRER SEITE

NUMÉRIQUEMENT À VOS CÔTÉS · DIGITAAL AAN UW KANT · ACOMPAÑAMIENTO DIGITAL · DIGITALMENTE AL VOSTRO FIANCO · DIGITAL LA ÎNDEMÂNĂ DUMNEAVOASTRĂ · DIGITAALISUUS PUOLELLASI · CYFROWO PO TWOJEJ STRONIE

FR

L'élément du succès numérique au service d'une communication moderne – notre portail B2B myTRIO.

Avantages offerts aux partenaires commerciaux enregistrés.

Bénéficiez de notre assistance simple et rapide ! En un clic vous accédez à toutes les données d'éléments importants et pourrez facilement télécharger des fichiers. Découvrez ces avantages sur notre portail B2B numérique myTRIO. Les utilisateurs enregistrés y trouveront toutes les informations pertinentes sur nos produits, des détails techniques aux images et la quantité de produits en stock. Vous n'êtes pas encore enregistré ? N'hésitez pas à nous contacter.



NL

Het digitale succeselement voor moderne communicatie - ons B2B-portaal myTRIO.

Voordelen voor geregistreerde zakenpartners.

Profiteer van onze snelle en ongecompliceerde ondersteuning! Met slechts één klik hebt u toegang tot alle belangrijke artikelgegevens en kunt u eenvoudig bestanden downloaden. Ontdek deze voordelen in ons digitale B2B-portaal myTRIO. Geregistreerde gebruikers vinden er alle relevante informatie over onze producten, van technische details tot afbeeldingen en voorraadniveaus. Bent u nog niet geregistreerd? Aarzel niet om contact op te nemen met ons.

ES

El Elemento de Éxito Digital para la Comunicación Moderna: nuestro portal myTRIO B2B.

Ventajas para socios comerciales registrados.

¡Disfrute de los beneficios de nuestra asistencia rápida y sencilla! Con un solo clic, tendrá acceso a toda la información importante del artículo y podrá descargar los archivos sin inconvenientes. Descubra estos beneficios en nuestro portal myTRIO digital B2B. Los usuarios registrados encontrarán toda la información importante sobre nuestros productos en el portal, desde los detalles técnicos hasta las imágenes y la cantidad de productos en stock. ¿Todavía no está registrado? No dude en consultarnos.

IT

Il nostro portale B2B myTRIO: il fattore di successo digitale per una comunicazione moderna.

Vantaggi per i partner commerciali registrati.

Usufruisci della nostra assistenza, rapida e semplice! Basta un clic per avere accesso a tutti i dati più importanti sui prodotti e per scaricare con facilità i file. Vieni a scoprire questi vantaggi nel nostro portale digitale B2B myTRIO. Gli utenti registrati troveranno informazioni dettagliate sui nostri prodotti, dalle specifiche tecniche alle immagini fino alle giacenze di magazzino. Ancora non sei registrato? Non esitare a contattarci.

RO

Elementul de succes digital pentru comunicare modernă - portalul B2B myTRIO.

Avantaje pentru mărcile partenere înregistrate.

Beneficiați de asistența noastră rapidă și extrem de simplă! Cu un singur clic puteți avea acces la toate datele privind produsele importante și puteți descărca ușor fișiere. Descoperiți aceste avantaje în portalul B2B digital myTRIO. Aici, utilizatorii înregistrați pot găsi toate informațiile relevante despre produsele noastre, de la detalii tehnice la imagini și numărul de produse aflate în stoc. Încă nu v-ați înregistrat? Nu ezitați să ne contactați.

FI

Digitaalinen menestyksessä elementtimme modernilla tiedonvälityksellä — TRIO B2B Partners -portaalimme.

Etuja rekisteröidyille liiketoimintakumppaneille.

Etua nopeasta ja toimivasta tuestamme! Vain yhdellä napsautuksella saat tärkeitä tietoja ja voit ladata helposti tiedostoja. Tutustu näihin etuihin myTRIO digital B2B -portaalissamme. Rekisteröityneet käyttäjät löytävät kaikki mahdolliset tiedot tuotteistamme, tekniset tiedot, kuvan tuotteistamme ja varastossa olevien tuotteiden määrän. Etkö ole vielä rekisteröitynyt? Voit aina ottaa meihin yhteyttä.

PL

Cyfrowy element sukcesu na rzecz nowoczesnej komunikacji – oto nasz portal B2B myTRIO.

Korzyści dla zarejestrowanych partnerów biznesowych.

Skorzystaj z naszego szybkiego i prostego wsparcia! Wystarczy jedno kliknięcie, a zyskasz dostęp do wszystkich istotnych danych wybranego elementu i możesz wygodnie pobierać pliki. Odkryj te korzyści na naszym cyfrowym portalu B2B myTRIO. Zarejestrowani użytkownicy znajdą tam wszystkie ważne informacje o naszych produktach – od szczegółów technicznych aż po zdjęcia i stany magazynowe. Nie jesteś jeszcze zarejestrowany? Zachęcamy do skontaktowania się z nami.

FR

Vous pouvez également nous consulter depuis le confort de votre propre maison !

Plongez-vous dans le monde virtuel et explorez notre showroom grâce à une visite interactive à 360°. Que ce soit sur un PC, une tablette ou un smartphone, la visite est directement disponible sur votre navigateur internet. La présentation est particulièrement impressionnante si vous utilisez des lunettes de réalité virtuelle. Vous trouverez davantage d'informations sur notre site internet. N'hésitez pas à le visiter et à profiter de l'expérience. Profitez-en !

NL

Bezoek ons ook vanuit het comfort van uw eigen huis!

Duik in de virtuele wereld en verken onze showroom met onze interactieve 360°-rondleiding. Of het nu op een pc, tablet of smartphone is, de tocht is direct voor u beschikbaar in uw webbrowser. De presentatie is vooral indrukwekkend, wanneer u een VR-bril gebruikt. Meer informatie vindt u op onze website. Kom gerust even langs en geniet van de ervaring. Veel plezier!



ES

¡También nos puede visitar desde la comodidad de su propio hogar!

Sumérjase en el mundo virtual y explore nuestra sala de exposiciones con una visita interactiva de 360°. La visita está disponible en su navegador web y puede acceder desde su PC, tablet o teléfono inteligente. La presentación se torna especialmente interesante si usa las gafas de realidad virtual. Puede encontrar más información en nuestro sitio web. Está invitado a visitarlo y disfrutar de la experiencia. ¡Que lo disfrute!

IT

Puoi venirci a trovare anche comodamente da casa tua!

Fai un salto nell'universo virtuale ed entra nel nostro showroom partecipando al nostro tour interattivo a 360°. Da PC, tablet o smartphone, il tour è disponibile direttamente nel browser web. L'esperienza sarà particolarmente suggestiva se utilizzerai gli occhiali VR. Per ulteriori informazioni, visita il nostro sito web. Vieni a trovarci e lasciati incantare da questa esperienza. E buon divertimento!

RO

De asemenea, puteți să ne vizitați din confortul casei dumneavoastră!

Pătrundeți în lumea virtuală și explorați magazinul nostru de prezentare cu ajutorul turului interactiv de 360°. Pe computer, tabletă sau telefonul inteligent, turul este disponibil direct în browserul web. Prezentarea devine în mod special impresionantă dacă folosiți ochelari VR. Puteți găsi mai multe informații pe site-ul nostru web. Nu ezitați să faceți o vizită și să vă bucurați de experiență. Distracție plăcută!

FI

Voit myös tavoittaa meidät Comfort of Your Own Home -sivustosta!

Lähde virtuaaliseen maailmaan ja katso esittelytilaamme 360 asteen interaktiivisella kierroksella. Voit nähdä kaiken tietokoneesii, älypuhelimesi tai tablettisi selaimella. Esitys on erityisen näyttävä, jos sinulla on VR-lasit. Lisätietoja löydät verkkosivustoltamme. Voit välillä keskeyttää ja jatkaa taas. Nauti!

PL

Możesz także odwiedzić nas, przebywając w zaciszu własnego domu!

Zanurz się w wirtualnym świecie i odkryj nasz salon wystawowy produktów na sprzedaż dzięki interaktywnej wycieczce 360°. Skorzystaj z komputera, tabletu lub smartfona – wycieczka jest dostępna bezpośrednio w przeglądarce internetowej. Prezentacja będzie szczególnie imponująca, jeśli użyjesz okularów VR. Więcej informacji można znaleźć na naszej stronie internetowej. Zapraszamy – wstąp do nas i zobacz, co dla Ciebie przygotowaliśmy. Życzymy przyjemnie spędzonego czasu!

GET YOUR LIGHT CONNECTED.

FR NL ES IT RO FI PL

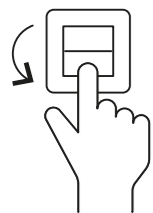

WiZ CLICK

Simple et efficace. Deux modes d'éclairage préférés peuvent être commandés via l'interrupteur d'éclairage existant.

Eenvoudig en effectief. Twee voorkeurstellingen kunnen worden bediend via de bestaande lichtschakelaar.

Helppoa ja tehokasta. Kaksi toivottua valo asetusta jota voidaan käyttää seinäkytkimellä.

Simple y efectivo. Dos ambientes de luz preferidos pueden operar a través del interruptor convencional.

Semplice ed efficace. È possibile utilizzare due modalità di illuminazione preferite tramite l'interruttore della luce esistente.

Proste i efektywne. Dwa preferowane tryby oświetlenia można obsługiwać za pomocą dostępnego przełącznika oświetlenia.

Simple y efectivo. Dos ambientes de luz preferidos pueden operar a través del interruptor convencional.

Proste i efektywne. Dwa preferowane tryby oświetlenia można obsługiwać za pomocą dostępnego przełącznika oświetlenia.

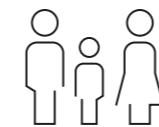

Multiples utilisateurs

Le nombre de personnes pour contrôler les lumières peut être déterminé individuellement.

Meerdere gebruikers

Het aantal personen dat de lampen aanstuurt, kan individueel worden ingesteld.

Monta eri käyttäjää

WiZ käyttäjien määrä voidaan yksilöllisesti määrittää.

Utilizatori multipli

Numarul de persoane care sa controleze luminile poate fi setat individual.

Basé sur le cloud

WiZ se connecte au cloud pour stocker les préférences, partager les désirs et générer automatiquement des mises à jour.

Cloud gebaseerd

WiZ maakt verbinding met de cloud om voorkeuren op te slaan, wensen te delen en automatische updates te genereren.

Pilvipalveluun perustuva

WiZ ottaa yhteyden pilvipalveluun, tallentaa asetukset ja luo päivitykset automaattisesti.

Pe baza de Cloud

WiZ te conectează la Cloud la magazinul preferat, transmite dorințele și generează update-uri în mod automat.



Lieux multiples

Toutes les lumières peuvent être assignées à différentes pièces et contrôlées avec précision - individuellement ou en groupe.

Meerder woonruimtes

Alle lampen kunnen worden toegewezen aan verschillende woonruimtes en nauwkeurig worden aangestuurd - individueel of in groepen.

Useita huoneita

Jokainen valo voidaan määrittää eri huoneelle. Hallittavissa ryhmissä tai yksittäin.

Câteva camere

Toate luminile pot fi atribuite mai multor camere diferite și pot fi controlate cu precizie - individual și în grupuri.



Pas besoin de pont

Il n'y a pas besoin d'un dispositif supplémentaire pour contrôler les lumières.

Geen hub nodig

Er is geen extra apparaat nodig om de lampen aan te sturen.

Ei tarvetta erilliselle keskukselle

Ei tarvetta erilliselle keskukselle valojen säätämiseen.

Nu e nevoie de nici un punct central

Nu e nevoie de o punte sau hub pentru a controla luminile.



Technologie WiFi

WiZ utilise la technologie WiFi comme une solution sans fil sécurisée, indépendante, abordable et facile à installer.

WiFi-technologie

WiZ gebruikt Wi-Fi-technologie als een veilige, onafhankelijke, betaalbare en eenvoudig te installeren draadloze oplossing.

WiFi teknologia

WiZ käyttää Wi-Fi teknologiaa turvallisena, itsenäisenä, edullisena ja helppo käyttöisenä langattomana ratkaisuna.

Technologie WiFi

WiZ folosește tehnologia Wi-Fi ca o soluție de internet sigură, independentă, permisivă și ușor de instalat.

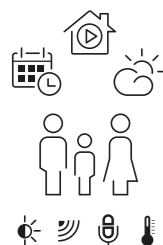

WiZ MAGIC

Contrôle des lumières par programme horaire, par capteurs ou par simples commandes vocales. Compatible avec Amazon Alexa et Google Home.

Aansturing van de lampen met tijdschema's, door sensoren of via eenvoudige spraakopdrachten. Compatibel met Amazon Alexa en Google Home.

Valoja voi säätää aikataulutetusti, sensoreilla tai yksinkertaisilla ääni komennoilla. Yhteensopiva Amazon Alexan ja Google Homen kanssa.

Controlul luminilor prin programarea orei/timpului, cu senzori sau printr-o simplă comandă verbală. Compatibil cu Amazon Alexa și Google Home.

Controllo delle luci secondo gli orari, con sensori o semplici comandi verbali. Compatibile con Amazon Alexa e Google Home.

Control de las luces con horarios, con sensores o por simples comandos de voz. Compatible con Alexa de Amazon y Google Home.

Ustawianie i sterowanie lampami za pomocą harmonogramów.

Facile e veloce da installare. Piena funzionalità e flessibilità con l'App Wiz disponibile su App Store e su Google Play.

Fácil y rápido de instalar. Amplia funcionalidad y flexibilidad con la aplicación WiZ, disponible en la App Store o en Google Play.

Prosta i szybka instalacja. Pełna funkcjonalność i elastyczność dzięki aplikacji WiZ – dostępnej w App Store lub Google Play.

Controllo tramite telecomando e possibilità di salvare quattro modalità luce preferite.

Control vía mando a distancia y con posibilidad de guardar 4 ambientes favoritos.

Możliwość sterowania za pomocą pilota i zapisywania czterech preferowanych trybów oświetlenia.

Molteplici Location

Controllo e comando più sedi contemporaneamente e da qualsiasi luogo. Che tu sia casa tua o la tua casa vacanza.

Múltiples localizaciones

Control y cambio en múltiples localizaciones simultáneamente, tanto tu casa como en tu segunda residencia.

Kilka lokalizacji

Kontrola i sterowanie z kilku lokalizacji jednocześnie i zewsząd. Czy to z własnego domu, czy też z wakacyjnego mieszkania.

WiZ APP

Installation facile et rapide. Toutes les fonctionnalités et flexibilité disponible avec l'application WiZ, téléchargeable sur App Store ou Google Play.

Eenvoudig en snel te installeren. Volledige functionaliteit en flexibiliteit met de WiZ-app - beschikbaar in de App Store of op Google Play.

Helppo ja nopea asentaa. Käyttö WiZ-aplikaatiolla - saatavissa App Storesta tai Google Play kaupasta.

Instalare usoara si rapida. Functionalitate completa si flexibilitate cu WIZ App - disponibil pe App store sau pe Google Play.



WiZ MOTE

Contrôle via la télécommande et possibilité de sauvegarder quatre modes d'éclairage favoris.

Aansturen via de afstandsbediening en mogelijkheid om vier favoriete licht instellingen te bewaren.

Toimintojen säätö kaukosäätimellä ja mahdollisuus tallentaa neljä valo asetusta.

Controlul prin telecomanda și posibilitatea de a memora/salva 4 moduri favorite.



Résidences multiples

Contrôlez et commandez plusieurs résidences simultanément et de n'importe où. Que ce soit votre propre maison ou votre deuxième résidence.

Meerdere locaties

Controleren en aansturen van meerdere locaties tegelijkertijd en van overal. Uw thuis of uw vakantiehuis.

Useita sijainteja

Voit hallita useita sijainteja, kotiasi tai kesäasuntoasi samanaikaisesti.

Locatii Multiple

Control și comanda a locațiilor multiple simultan și de oriunde. Fie ca te afli acasă sau în casa de vacanță.



Système de voie à deux phases (230 V) · 2-fase-spoorsysteem (230 V) · Sistema de rieles en 2 fases (230 V) · Sistema a binario bifase (230 V) · Sistem de piste cu 2 faze (230 V) · 2-vaihekiskojärjestelmä (230 V) · 2-fazowy system prowadnic (230 V)

 FR NL ES IT RO FI PL

ⓘ Lors de la planification, veuillez prêter une attention particulière à la position du conducteur de protection, qui doit être connecté en permanence dans le système.

Let bij de planning absoluut op de positie van de beschermende geleider die binnen het systeem ononderbroken verbonden moet zijn.

Al planificar, por favor, tenga en cuenta la posición de la toma de tierra, que debe estar conectado a lo largo de todo el sistema.

In fase di progettazione, prestare attenzione alla posizione del conduttore di protezione, che deve essere collegato in modo continuo all'interno dell'impianto.

La planificare, luați neapărat în considerare poziția conductorului de protecție, care trebuie să fie conectat continuu în interiorul sistemului.

Huomioi suunnittelussa koko järjestelmään kytkettävän suojavaadoituksen sijainti.

Podczas projektowania należy zwrócić uwagę na położenie przewodu ochronnego, który musi być podłączony w całym systemie.

1 Rail

La longueur maximale de l'installation est de 30 mètres par alimenta-tion, avec une puissance totale maximale de 600 watts par phase.

Spoor

De maximale montagelengte bedraagt 30 meter per voeding, bij een een totaal vermogen van max. 600 watt per fase.

Riel

La longitud máxima de montaje es de 30 metros por alimentación, con una potencia total de 600 vatios como máximo por fase.

Binario

La lunghezza massima di installazione è di 30 metri per ogni alimentazione, con una potenza totale di max. 600 watt per fase.

Pistă

Lungimea maximă de montaj este de 30 de metri pe fiecare sursă de alimentare, la o putere totală de max. 600 W pe fază.

Kisko

Asennuksen enimmäispituus on 30 metriä syöttöä kohti,

kokonaisteho enintään 600 W/vaihe.

Szyna

Maksymalna długość montażu wynosi 30 metrów na linię zasilania z łączną mocą 600 watów na jedną fazę.

2 Profil encastré

Verzonken profiel

Perfil empotrado

Profilo incassato

Profil încastrat

Upotettu profiili

Profil wpuszczany

3 Alimentation électrique intermédiaire/finale

L'alimentation du milieu/extrémité est montée directement au-dessus de la prise de courant et permet de connecter des rails d'un côté ou des deux côtés.

Midden-/eindevoeding

De midden-/eindevoeding wordt direct over de stroomuitgang aangebracht en maakt het mogelijk sporen op één of beide kanten aan te sluiten.

Alimentación medios/extremos

La alimentación de medios/extremos se adapta directamente mediante la toma de corriente, y permite que las lámparas se conecten por un lado o por los dos.

Alimentazione centrale/finale

L'alimentazione centrale/finale è montata direttamente sopra la presa di corrente e consente di collegare le guide su un lato o su entrambi i lati.

Alimentare centrală/finală

Alimentare centrală/finală este realizată direct prin intermediul conexiunii electrice și permite conectarea pistolor pe o parte sau pe ambele părți.

Keski-/päätyysöttö

Keski/päätyysöttö asennetaan suoraan pistorasian yläpuolelle, ja se mahdollistaa kiskojen kytkemisen toiselle tai molemmille puoleille.

Zasilanie pośrednie / końcowe

Zasilanie środkowe / końcowe jest instalowane bezpośrednio nad gniazdem zasilania i umożliwia podłączenie szyn z jednej lub z obu stron.

4 Alimentation intermédiaire/finale avec changeur de phase électronique

Grâce à un changeur de phase électronique, les deux phases peuvent être commutées et atténuées séparément, même avec des lignes électriques à trois conducteurs.

Midden-/eindevoeding met elektronische fasewisselaar

Door middel van een elektronische fasewisselaar kunnen de twee fasen ook bij driedradige stroomleidingen apart geschakeld en gedimd worden.

Alimentación medios/extremos con cambiador de fase electrónico

Por medio de los cambiadores de fase electrónicos, las dos fases pueden activarse y atenuarse también mediante cables de corriente de tres filamentos.

Alimentazione centrale/finale con variatore di fase elettrico

Mediante un variatore di fase elettrico, le due fasi possono essere commutate e dimmerate separatamente, anche con linee di alimentazione a tre conduttori.

Alimentare centrală/finală cu schimbător electronic de fază

Prin intermediul dispozitivului electronic de schimbare a fazelor se pot comuta și regla două faze chiar și în cazul cablurilor electrice cu trei fire.

Keski-/päätyysöttö elektronisella vaihtimella

Sähköistä vaihdinta käyttämällä nämä kaksi vaihetta voidaan kytkeä ja himmentää erikseen jopa kolmijohtimisella kaapeloinnilla.

Zasilanie pośrednie / końcowe z elektronicznym przełącznikiem faz

Za pomocą elektronicznych zmieniaczy faz obie fazy można przełączać i przyciemniać osobno, nawet w przypadku trójprzewodowych linii zasilania.

5 Connecteur longitudinal

Relie deux rails entre eux pour des sections droites.

Longitudale verbinder

Verbindt twee sporen voor rechte stukken met elkaar.

Ensamblaje recto

Ensemble dos rieles para tramos rectos entre si.

Connettore longitudinale

Unisce due binari per sezioni rettilinee.

Conector longitudinal

Conectează două piste pentru trasee drepte unele cu altele.

Suora liitin

Yhdistää kaksi kiskoa suoria osuuksia varten.

Przedłużacz

Łączy dwie szyny dla prostych odcinków.

6 Connecteur Flex

Relie deux rails entre eux sous n'importe quel angle et relie le montage au plafond à celui au mur.

Flexibele verbinder

Verbindt twee sporen in een willekeurige hoek met elkaar en maakt de verbinding tussen plafond- en muurmontage mogelijk.

Ensamblaje flexible

Ensemble dos rieles con cualquier ángulo entre si y permite la conexión entre el montaje en techo y paredes.

Connettore flessibile

Collega tra loro due binari con qualsiasi angolazione e consente il collegamento tra il montaggio a soffitto e a parete.

Conector Flex

Conectează două șine într-un unghi aleatoriu între ele și permite conectarea între sistemele de montaj pe plafon și pe perete.

Flex-liitin

Yhdistää kaksi kiskoa mihin tahansa kulmaan ja mahdollistaa yhteyden katto- ja seinäkiinnityksen välillä.

Łącznik elastyczny

Łączy dwie szyny pod dowolnym kątem i umożliwia połączenie między sufitem a ścianą.

7 Raccord en L

Relie deux rails entre eux à angle droit.

L-Connector

Verbindt twee sporen in een rechte hoek met elkaar.

Conector en L

Ensemble dos rieles en ángulo recto entre si.

Connettore a L

Collega insieme due binari ad angolo retto.

Conector în L

Conectează două piste pentru trasee în unghi drept unele cu altele.

L-Liitin

Yhdistää kaksi kiskoa toisiinsa suorassa kulmassa.

Złącze L

Łączy dwie szyny pod kątem prostym.

9 Raccord en T

Relie trois rails entre eux à angle droit.

T-Connector

Verbindt drie sporen in een rechte hoek met elkaar.

Conector en T

Ensemble tres rieles en ángulo recto entre si.

Connettore a T

Collega insieme tre binari ad angolo retto.

Conector în T

Conectează trei șine în unghi drept unele de altele.

T-Liitin

Yhdistää kolme kiskoa suorassa kulmassa toisiinsa.

Złącze T

Łączy trzy szyny pod kątem prostym.

12 Connecteur X

Relie quatre rails entre eux à angle droit.

X-verbinder

Verbindt vier sporen in een rechte hoek met elkaar.

Ensamblaje en X

Ensemble cuatro rieles en ángulo recto entre si.

Connettore a X

Collega insieme quattro binari ad angolo retto.

Conector X

Conectează patru șine în unghi drept între ele.

X-liitin

Yhdistää neljä kiskoa suorassa kulmassa toisiinsa nähden.

Łącznik X

Łączy cztery szyny pod kątem prostym.

18 Adaptateur pendulaire

Cet adaptateur pendulaire permet d'intégrer des luminaires suspendus conventionnels dans le système de rail DUOLine.

Hangadapter

Deze hangadapter maakt het mogelijk gewone hanglampen in het DUOLine-spoorsysteem te integreren.

Adaptador colgante

Este adaptador colgante le permite integrar las lámpara colgantes convencionales en el sistema de rieles de DUOLine.

Adattatore per sospensione

Questo adattatore per sospensione consente l'integrazione di lampade a sospensione convenzionali nel sistema a binario DUOLine.

Adaptor lustre

Acest adaptor pendular permite integrarea lustrelor uzuale în sistemul de piste DUOLine.

Riippuvalaisinsovitin

Tämä riippuvalaisinsovitin mahdollistaa tavallisten riippuvalaisimien integroinnin DUOLine-kiskojärjestelmään.

Adapter zawieszania

Ten adapter do zawieszania umożliwia zintegrowanie tradycyjnych lamp wiszących z systemem szyn DUOLine.

15 Raccourcisseur de câble

Permet de raccourcir les câbles des luminaires suspendus.

Snoerverkorter

Maakt het inkorten van het snoer van hanglampen mogelijk.

Acortador de cable

Es posible acortar el cable de las lámparas colgantes.

Sistema per accorciare il cavo

Permette di accorciare i cavi delle lampade a sospensione.

Prescurtare cablu

Permite scurtarea cablurilor lustrelor.

Johdon lyhennin

Mahdollistaa riippuvalaisimen johdon lyhentämisen.

Skracacz kabla

Pozwala skrócić kable lamp wiszących.

16 Suspension

Afstandhouder

Suspensión

Sospensione

Suspensie

Ripustus

Zawieszenie

18 Embouts

Eindkappen

Tapones

Tappi terminali

Capace de capăt

Päätykappaleet

Zaślepki

19 Couvercle de remplacement de l'adaptateur

Vervangende afdekking voor adapter

Tapa de recambio para adaptador

Coperchio di ricambio per adattatore

Capac de înlocuire pentru adaptor

Adapterin korvaava suojus

Wymienna pokrywa adaptera

20 Isolateur

Grâce à un isolateur, deux circuits séparés peuvent être reliés optiquement pour former un système.

Isolator

Door middel van de isolator kunnen twee aparte stroomkringen optisch verbonden worden tot één systeem.

Aislador

Por medio del aislador pueden conectarse dos circuitos de forma óptica a un sistema.

Isolatore

Utilizzando un isolatore, due circuiti separati possono essere collegati otticamente per formare un sistema.

Izolator

Prin intermediul izolatorului este posibilă conectarea optică a două circuite de comutare într-un sistem.

Eristin

Eristimen avulla kaksi erillistä piiriä voidaan kytkeä optisesti yhden järjestelmän muodostamiseksi.

Izolator

Za pomocą izolatora można optycznie połączyć dwa oddzielne obwody w celu utworzenia systemu.

21 Alimentation électrique flexible

L'alimentation électrique flexible est nécessaire si les rails ne peuvent pas être posés directement sur la prise de courant.

Flexibele stroomtoevoer

Flexibele stroomtoevoer is nodig, als de sporen niet direct over de stroomuitgang gelegd kunnen worden.

Suministro de corriente flexible

El suministro de corriente flexible será necesario si las lámparas no pueden desplegarse directamente sobre la toma de corriente.

Sistema di alimentazione flessibile

Il sistema di alimentazione flessibile è necessario se i binari non possono essere posati direttamente sulla presa di corrente.

Alimentarea electrică flexibilă

Alimentarea electrică flexibilă este necesară atunci când pistele nu pot fi pozate direct prin intermediul racordului electric.

Joustava virransyöttö

Joustava virtälähde on tarpeen, jos kiskoja ei voida asentaa suoraan pistorasian yläpuolelle.

Elastyczne zasilani

Elastyczny zasilanie jest wymagane, jeśli szyny nie mogą być układane bezpośrednio nad gniazdem zasilania.

INDEX · NUMERIC

| Seite Page | Artikel-Nr. Product No. | EAN-Nummer EAN-Number | Ersatzteile Spare parts |
|---------------|----------------------------|--------------------------|----------------------------|
| 156 | 101000324 | 4017807504675 | G1010-01 |
| 156 | 101000524 | 4017807504682 | G1010-01 |
| 243 | 101600506 | 4017807430165 | |
| 243 | 101600806 | 4017807430172 | |
| 249 | 101700332 | 4017807522730 | |
| 249 | 101700532 | 4017807522747 | |
| 240 | 102000403 | 4017807387919 | |
| 240 | 102000405 | 4017807387926 | |
| 248 | 110600331 | 4017807343656 | |
| 248 | 110600531 | 4017807343670 | |
| 160 | 110700328 | 4017807354140 | 92809 |
| 160 | 110700528 | 4017807354164 | 92809 |
| 362 | 200200132 | 4017807463019 | |
| 363 | 200300132 | 4017807462982 | |
| 362 | 200600132 | 4017807462821 | S2006-02 |
| 161 | 200700128 | 4017807354188 | 92809 |
| 364 | 200970124 | 4017807211832 | 92396 |
| 367 | 201000101 | 4017807409642 | |
| 366 | 201100201 | 4017807409666 | |
| 116 | 201200100 | 4017807398632 | 92854 |
| 112 | 202000108 | 4017807436051 | G2020-01 |
| 110 | 202000132 | 4017807506372 | G2020-01 |
| 110 | 202000142 | 4017807432893 | G2020-54 |
| 117 | 202500101 | 4017807364927 | 92831-20 |
| 369 | 202620131 | 4017807575057 | |
| 369 | 202620132 | 4017807575040 | |
| 368 | 202670107 | 4017807524017 | |
| 368 | 202670108 | 4017807526547 | |
| 368 | 202670131 | 4017807524055 | |
| 368 | 202670132 | 4017807524079 | |
| 188 | 203000132 | 4017807522716 | |
| 115 | 204400101 | 4017807364972 | 92830-22 |
| 182 | 205570167 | 4017807442540 | |
| 182 | 205570267 | 4017807442564 | |
| 354 | 206400279 | 4017807364361 | |
| 354 | 206500279 | 4017807364378 | |
| 154 | 208070132 | 4017807407242 | |
| 423 | 208870132 | 4017807388473 | |
| 122 | 209100107 | 4017807398564 | S5091-01 |
| 122 | 209100108 | 4017807398571 | S5091-01 |
| 114 | 212200100 | 4017807522013 | G2122-52 |
| 467 | 212400201 | 4017807408799 | |
| 467 | 212400204 | 4017807490510 | |
| 467 | 212400207 | 4017807408850 | |
| 467 | 212400224 | 4017807408867 | |
| 467 | 212400232 | 4017807408812 | |
| 342 | 212600130 | 4017807526288 | G21261-01 |
| 342 | 212600156 | 4017807526561 | G21261-01 |
| 342 | 212600230 | 4017807526318 | G21262-01 |
| 342 | 212600256 | 4017807526578 | G21262-01 |
| 365 | 212700104 | 4017807522129 | G21271-01 |
| 365 | 212700107 | 4017807522112 | G21271-01 |
| 365 | 212700204 | 4017807522143 | G21272-01 |
| 365 | 212700207 | 4017807522136 | G21272-01 |

| Seite Page | Artikel-Nr. Product No. | EAN-Nummer EAN-Number | Ersatzteile Spare parts |
|---------------|----------------------------|--------------------------|----------------------------|
| 193 | 212870236 | 4017807567977 | S21282-01 T2128-00 |
| 193 | 212879236 | 4017807567960 | S21281-01 T2128-00 |
| 382 | 214470107 | 4017807539493 | S2144-01 |
| 382 | 214470108 | 4017807539523 | S2144-01 |
| 382 | 214470132 | 4017807539554 | S2144-01 |
| 351 | 220810201 | 4017807258363 | 92335 |
| 351 | 220810205 | 4017807258370 | 92335 |
| 358 | 222370231 | 4017807387025 | |
| 358 | 222370232 | 4017807387032 | |
| 359 | 222570231 | 4017807399875 | |
| 359 | 222570232 | 4017807399882 | |
| 348 | 223310105 | 4017807371765 | T2233-00 |
| 348 | 223310131 | 4017807371772 | T2233-00 |
| 348 | 223310132 | 4017807371789 | T2233-00 |
| 349 | 223410131 | 4017807303025 | |
| 349 | 223410132 | 4017807306309 | |
| 90 | 223510131 | 4017807421859 | |
| 90 | 223510132 | 4017807421910 | |
| 90 | 223510231 | 4017807421965 | |
| 90 | 223510232 | 4017807421996 | |
| 180 | 223710130 | 4017807441871 | |
| 180 | 223790130 | 4017807441895 | |
| 355 | 224110179 | 4017807329018 | |
| 346 | 224210102 | 4017807465914 | T2242-01 |
| 346 | 224290102 | 4017807465921 | T2242-01 |
| 352 | 224810132 | 4017807502756 | |
| 352 | 224810167 | 4017807502763 | |
| 352 | 224819132 | 4017807502787 | |
| 352 | 224819167 | 4017807502794 | |
| 348 | 224910231 | 4017807454413 | |
| 348 | 224910232 | 4017807454437 | |
| 347 | 225172924 | 4017807404517 | T22511-00 |
| 347 | 225172931 | 4017807404555 | T22511-00 |
| 347 | 225172942 | 4017807433401 | T22511-00 |
| 347 | 225174724 | 4017807404586 | T22512-00 |
| 347 | 225174731 | 4017807404593 | T22512-00 |
| 347 | 225174742 | 4017807433425 | T22512-00 |
| 360 | 225210104 | 4017807256314 | |
| 360 | 225210107 | 4017807256338 | |
| 350 | 225510207 | 4017807277913 | |
| 357 | 229210207 | 4017807413304 | T2292-00 |
| 357 | 229210231 | 4017807413281 | T2292-00 |
| 357 | 229210232 | 4017807413298 | T2292-00 |
| 166 | 241110131 | 4017807572193 | T2411-00 |
| 166 | 241110132 | 4017807572209 | T2411-00 |
| 172 | 241670132 | 4017807542516 | T2416-00 |
| 64 | 241810205 | 4017807541793 | T2418-00 |
| 62 | 241810208 | 4017807541861 | T2418-00 |
| 268 | 242910180 | 4017807550726 | T64291-00 |
| 364 | 2522011-06 | 4017807080797 | 92105 |
| 52 | 255410207 | 4017807415162 | |
| 124 | 271170201 | 4017807247251 | |
| 124 | 271170202 | 4017807247268 | 92765-02 |

| Seite Page | Artikel-Nr. Product No. | EAN-Nummer EAN-Number | Ersatzteile Spare parts |
|---------------|----------------------------|--------------------------|----------------------------|
| 124 | 271170211 | 4017807508680 | 92765-11 |
| 356 | 271470207 | 4017807374681 | 92940-01 |
| 356 | 271470279 | 4017807374698 | 92940-02 |
| 375 | 272970401 | 4017807284652 | |
| 375 | 272970487 | 4017807284669 | |
| 375 | 272970701 | 4017807284676 | |
| 375 | 272970787 | 4017807284683 | |
| 374 | 273070401 | 4017807284690 | |
| 374 | 273070701 | 4017807284706 | |
| 374 | 273071301 | 4017807284713 | |
| 374 | 273071801 | 4017807284720 | |
| 372 | 273170301 | 4017807284737 | |
| 372 | 273170387 | 4017807284744 | |
| 372 | 273170401 | 4017807284751 | |
| 372 | 273170487 | 4017807284768 | |
| 371 | 273370307 | 4017807284799 | |
| 350 | 274670105 | 4017807293968 | |
| 350 | 274670205 | 4017807293975 | |
| 418 | 274770132 | 4017807390056 | |
| 430 | 279770104 | 4017807275346 | |
| 430 | 279770107 | 4017807275353 | |
| 430 | 279770108 | 4017807275360 | |
| 430 | 279770132 | 4017807542363 | |
| 544 | 2803021-06 | 4017807147599 | 9579-01 |
| 544 | 2803031-06 | 4017807147605 | 9579 |
| 530 | 281570606 | 4017807245967 | |
| 530 | 281570906 | 4017807245950 | |
| 518 | 282410106 | 4017807280821 | |
| 518 | 282410206 | 4017807280838 | |
| 532 | 282990106 | 4017807345070 | |
| 520 | 283110106 | 4017807382846 | |
| 520 | 283110132 | 4017807508000 | |
| 520 | 283110206 | 4017807382853 | |
| 520 | 283110232 | 4017807508024 | |
| 528 | 283270106 | 4017807384048 | |
| 528 | 283270132 | 4017807508116 | |
| 528 | 283270206 | 4017807384055 | |
| 528 | 283270232 | 4017807508123 | |
| 528 | 283270306 | 4017807384062 | |
| 528 | 283270332 | 4017807508154 | |
| 551 | 283400106 | 4017807508246 | |
| 551 | 283400132 | 4017807508253 | |
| 550 | 283500106 | 4017807513967 | |
| 550 | 283500132 | 4017807513998 | |
| 533 | 283600406 | 4017807514018 | |
| 535 | 283770106 | 4017807508079 | |
| 535 | 283770132 | 4017807508086 | |
| 535 | 283779106 | 4017807508093 | |
| 535 | 283779132 | 4017807508109 | |
| 524 | 283811206 | 4017807507997 | |
| 524 | 283811232 | 4017807507980 | |
| 524 | 283814206 | 4017807507959 | T28381-00 |
| 524 | 283814232 | 4017807507942 | T28381-01 |
| 524 | 283817906 | 4017807507966 | T28382-00 |
| 524 | 283817932 | 4017807507973 | T28382-00 |

| Seite Page | Artikel-Nr. Product No. | EAN-Nummer EAN-Number | Ersatzteile Spare parts |
|---------------|----------------------------|--------------------------|--|
| 522 | 283916006 | 4017807507904 | |
| 522 | 283916032 | 4017807507911 | |
| 522 | 283919006 | 4017807507928 | |
| 522 | 283919032 | 4017807507935 | |
| 526 | 284071206 | 4017807507638 | |
| 526 | 284071232 | 4017807507645 | |
| 526 | 284074206 | 4017807507676 | |
| 526 | 284074232 | 4017807507683 | |
| 526 | 284077906 | 4017807507652 | |
| 526 | 284077932 | 4017807507669 | |
| 548 | 284114006 | 4017807507591 | D2841-06 |
| 548 | 284114032 | 4017807507607 | D2841-32 |
| 548 | 284116006 | 4017807507614 | D2841-06 |
| 548 | 284116032 | 4017807507621 | D2841-32 |
| 521 | 284270106 | 4017807585278 | G2842-01 |
| 521 | 284270132 | 4017807585285 | G2842-01 |
| 253 | 300900101 | 4017807298673 | |
| 253 | 300900102 | 4017807298680 | |
| 211 | 301000367 | 4017807478167 | G3010-52 |
| 116 | 301200300 | 4017807398649 | 92855 |
| 254 | 301300142 | 4017807390322 | |
| 254 | 301300342 | 4017807390346 | |
| 254 | 301300442 | 4017807390353 | |
| 260 | 301400101 | 4017807195422 | 92270-01 |
| 261 | 301700107 | 4017807196009 | 9408-01 |
| 261 | 301700108 | 4017807196016 | 9408-01 |
| 199 | 301900467 | 4017807502602 | |
| 112 | 302000308 | 4017807436112 | G2020-01 |
| 111 | 302000332 | 4017807506389 | G2020-01 |
| 111 | 302000342 | 4017807433067 | G2020-54 |
| 112 | 302000608 | 4017807522778 | G2020-01 |
| 110 | 302000632 | 4017807522754 | G2020-01 |
| 110 | 302000642 | 4017807522761 | G2020-54 |
| | | | G3020-54 |
| 194 | 302100130 | 4017807451252 | S30211-01 |
| 194 | 302100430 | 4017807451269 | S30212-01 |
| 232 | 302400404 | 4017807523355 | |
| 231 | 302400407 | 4017807523416 | |
| 231 | 302400431 | 4017807523492 | |
| 231 | 302400432 | 4017807523515 | |
| 232 | 302400480 | 4017807523454 | |
| 232 | 302400604 | 4017807523577 | |
| 231 | 302400607 | 4017807523591 | |
| 231 | 302400631 | 4017807523638 | |
| 231 | 302400632 | 4017807523652 | |
| 232 | 302400680 | 4017807523614 | |
| 117 | 302500301 | 4017807364934 | |
| 212 | 302900102 | 4017807292497 | 92779 |
| 188 | 303000132 | 4017807476781 | |
| 188 | 303090132 | 4017807476798 | |
| 141 | 303100417 | 4017807567779 | S3026-44 S3026-11 S3026-26 S3026-01 |

INDEX · NUMERIC

| Seite Page | Artikel-Nr. Product No. | EAN-Nummer EAN-Number | Ersatzteile Spare parts |
|---------------|----------------------------|--------------------------|--|
| 200 | 303400167 | 4017807425376 | |
| 200 | 303400367 | 4017807425383 | |
| 91 | 303500331 | 4017807422061 | C3035-01 |
| 91 | 303500332 | 4017807422078 | C3035-01 |
| 256 | 303700104 | 4017807286601 | |
| 256 | 303700162 | 4017807286625 | |
| 252 | 304100100 | 4017807247411 | |
| 252 | 304100106 | 4017807247404 | 92634-06 |
| 208 | 304300132 | 4017807467499 | |
| 208 | 304300432 | 4017807467567 | |
| 209 | 304330332 | 4017807467512 | |
| 115 | 304400201 | 4017807364989 | 92830-040 |
| 139 | 305400401 | 4017807336948 | 93782 |
| 139 | 305400411 | 4017807336955 | 93782-11 |
| 139 | 305400441 | 4017807391022 | 93782-41 |
| 139 | 305400479 | 4017807336962 | 93782-79 |
| 183 | 305500467 | 4017807441093 | |
| 213 | 305900126 | 4017807330816 | |
| 213 | 305900130 | 4017807330809 | |
| 152 | 306700602 | 4017807373912 | |
| 152 | 306700632 | 4017807364392 | |
| 153 | 306700732 | 4017807399905 | |
| 104 | 307601206 | 4017807426861 | G50761-54 |
| 244 | 308000132 | 4017807288827 | |
| 137 | 308200179 | 4017807392517 | |
| 118 | 308300307 | 4017807510638 | 92980-01 92983-07 |
| 120 | 308300308 | 4017807510645 | 92980-01 92983-08 |
| 106 | 308500542 | 4017807468601 | G40342-54 |
| 106 | 308590342 | 4017807468625 | G40342-54 |
| 242 | 308600706 | 4017807378306 | B3086-00 P3086-06 |
| 245 | 309300302 | 4017807354102 | 92836-04 92836-05 92836-06 92836-07 |
| 92 | 309800431 | 4017807387681 | 92887 |
| 92 | 309800432 | 4017807387698 | 92887 |
| 98 | 309900631 | 4017807330946 | |
| 98 | 309900632 | 4017807330953 | 92943 |
| 99 | 309900657 | 4017807573657 | G3099-57 |
| 212 | 310100104 | 4017807408607 | |
| 212 | 310100204 | 4017807408591 | |
| 257 | 310100562 | 4017807356045 | |
| 236 | 310300132 | 4017807532951 | G3103-54 |
| 236 | 310300532 | 4017807522471 | G3103-54 |
| 236 | 310390332 | 4017807522488 | G3103-54 |
| 247 | 310500332 | 4017807566826 | |
| 247 | 310500632 | 4017807566864 | |
| 108 | 310600132 | 4017807427264 | G0106-54 |
| 108 | 310600154 | 4017807507478 | G0106-54 |
| 108 | 310600432 | 4017807427288 | G0106-54 |
| 108 | 310600454 | 4017807507515 | G0106-54 |
| 108 | 310630332 | 4017807435696 | G0106-54 |

| Seite Page | Artikel-Nr. Product No. | EAN-Nummer EAN-Number | Ersatzteile Spare parts |
|---------------|----------------------------|--------------------------|--|
| 108 | 310630354 | 4017807507492 | G0106-54 |
| 246 | 310800108 | 4017807503845 | |
| 246 | 310800308 | 4017807503852 | |
| 246 | 310890108 | 4017807503838 | S31082-08 |
| 150 | 311100308 | 4017807537826 | |
| 150 | 311100367 | 4017807537703 | |
| 101 | 311210506 | 4017807367768 | 92829-40 92833-10 92833-12 92833-14 |
| 100 | 311210606 | 4017807367775 | 92829-50 92833-10 92833-12 92833-14 |
| 130 | 311400132 | 4017807538526 | |
| 130 | 311400432 | 4017807538410 | |
| 147 | 311900632 | 4017807536607 | |
| 147 | 311900732 | 4017807537949 | |
| 186 | 312200136 | 4017807544817 | |
| 114 | 312200200 | 4017807522006 | G3122-52 |
| 186 | 312200336 | 4017807544800 | |
| 184 | 312300136 | 4017807504620 | S3123-36 |
| 230 | 312400101 | 4017807408713 | |
| 230 | 312400107 | 4017807408737 | |
| 230 | 312400132 | 4017807408720 | |
| 230 | 312400401 | 4017807408751 | |
| 230 | 312400407 | 4017807408775 | |
| 230 | 312400432 | 4017807408768 | |
| 233 | 312490407 | 4017807523676 | |
| 233 | 312490431 | 4017807523690 | |
| 233 | 312490432 | 4017807523720 | |
| 233 | 312490607 | 4017807523744 | |
| 233 | 312490631 | 4017807523805 | |
| 233 | 312490632 | 4017807523843 | |
| 206 | 312700132 | 4017807502725 | |
| 206 | 312700432 | 4017807502718 | |
| 238 | 313100531 | 4017807538496 | G3131-01 |
| 238 | 313100532 | 4017807538519 | G3131-02 |
| 238 | 313100931 | 4017807538489 | G3131-01 |
| 238 | 313100932 | 4017807538472 | G3131-02 |
| 251 | 313300432 | 4017807503692 | |
| 204 | 313800332 | 4017807502855 | |
| 204 | 313800532 | 4017807502862 | |
| 250 | 313900132 | 4017807505061 | S3139-32 G3139-01 |
| 178 | 314300430 | 4017807538915 | |
| 105 | 315190132 | 4017807539646 | G3151-57 |
| 241 | 315200179 | 4017807287998 | |
| 190 | 315900132 | 4017807540246 | |
| 190 | 315900142 | 4017807540277 | |
| 102 | 317000332 | 4017807542271 | G31701-57 G31702-57 G31703-57 |

| Seite Page | Artikel-Nr. Product No. | EAN-Nummer EAN-Number | Ersatzteile Spare parts |
|---------------|----------------------------|--------------------------|-------------------------------------|
| 102 | 317000632 | 4017807542295 | G31701-57 G31702-57 G31703-57 |
| 102 | 317000832 | 4017807542301 | G31701-57 G31702-57 G31703-57 |
| 142 | 319000344 | 4017807574135 | |
| 144 | 319400417 | 4017807574593 | |
| 144 | 319400617 | 4017807574623 | |
| 144 | 319430317 | 4017807574609 | |
| 324 | 319500207 | 4017807574654 | G3195-01 |
| 324 | 319500232 | 4017807574630 | G3195-54 |
| 324 | 319500307 | 4017807574661 | G3195-01 |
| 324 | 319500332 | 4017807574647 | G3195-54 |
| 76 | 320310307 | 4017807487909 | T3203-00 |
| 76 | 320310308 | 4017807487916 | T3203-00 |
| 76 | 320310331 | 4017807487930 | T3203-00 |
| 76 | 320310332 | 4017807487923 | T3203-00 |
| 72 | 321210107 | 4017807454000 | T3212-00 |
| 72 | 321210108 | 4017807461145 | T3212-00 |
| 226 | 321611131 | 4017807468724 | T3216-00 92957 |
| 226 | 321611132 | 4017807468731 | T3216-00 |
| 226 | 321691131 | 4017807468748 | T3216-00 |
| 226 | 321691132 | 4017807468755 | T3216-00 |
| 81 | 321710107 | 4017807430486 | T3217-01 T3217-00 |
| 81 | 321710142 | 4017807430493 | T3217-01 T3217-00 |
| 229 | 321910307 | 4017807453584 | T3219-00 |
| 229 | 321910342 | 4017807453607 | T3219-00 |
| 86 | 322610431 | 4017807424294 | |
| 86 | 322610432 | 4017807424300 | |
| 164 | 322910532 | 4017807524963 | T3229-00 |
| 180 | 323710130 | 4017807451191 | |
| 82 | 325010105 | 4017807422627 | T3250-00 |
| 82 | 325010132 | 4017807422634 | T3250-00 |
| 228 | 325110131 | 4017807467758 | T3251-00 |
| 70 | 326210107 | 4017807505221 | |
| 70 | 326210132 | 4017807505214 | |
| 66 | 326510107 | 4017807510034 | T3260-00 |
| 66 | 326510108 | 4017807510041 | T3260-00 |
| 66 | 326510142 | 4017807510058 | T3260-00 |
| 66 | 326510207 | 4017807510065 | T32602-00 |
| 66 | 326510208 | 4017807510072 | T32602-00 |
| 66 | 326510242 | 4017807510089 | T32602-00 |
| 67 | 326510307 | 4017807510096 | T32603-00 |
| 67 | 326510308 | 4017807510102 | T32603-00 |
| 67 | 326510342 | 4017807510119 | |
| 175 | 326610232 | 4017807505474 | |
| 78 | 326810132 | 4017807506518 | T3268-00 |
| 224 | 327210305 | 4017807504200 | T3272-00 |
| 224 | 327210332 | 4017807504194 | T3272-00 |
| 88 | 340910131 | 4017807537956 | T34091-00 |
| 89 | 340910132 | 4017807537970 | T34091-00 |

| Seite Page | Artikel-Nr. Product No. | EAN-Nummer EAN-Number | Ersatzteile Spare parts |
|---------------|----------------------------|--------------------------|----------------------------|
| 88 | 340910331 | 4017807537994 | T34092-00 |
| 89 | 340910332 | 4017807538106 | T34092-00 |
| 74 | 341210305 | 4017807540161 | T3412-00 |
| 74 | 341210308 | 4017807540086 | T3412-00 |
| 173 | 341610132 | 4017807542455 | T3416-00 |
| 65 | 341810205 | 4017807540710 | T3418-00 |
| 63 | 341810208 | 4017807540734 | T3418-00 |
| 94 | 342010107 | 4017807542066 | G3420-01 T3420-00 |
| 94 | 342010108 | 4017807542080 | G3420-01 T3420-00 |
| 97 | 342010132 | 4017807542073 | G3420-57 T3420-00 |
| 94 | 342010207 | 4017807542097 | G3420-01 T34202-00 |
| 94 | 342010208 | 4017807542134 | G3420-01 T34202-00 |
| 97 | 342010232 | 4017807542127 | G3420-57 T34202-00 |
| 94 | 342010307 | 4017807542141 | G3420-01 T34203-00 |
| 94 | 342010308 | 4017807542158 | G3420-01 T34203-00 |
| 97 | 342010332 | 4017807542172 | G3420-57 T34203-00 |
| 225 | 342710205 | 4017807542318 | T3427-00 |
| 225 | 342710208 | 4017807542233 | T3427-00 |
| 217 | 343310305 | 4017807577822 | T3433-00 |
| 217 | 343310332 | 4017807577839 | T3433-00 |
| 217 | 343310365 | 4017807577815 | T3433-00 |
| 222 | 343610307 | 4017807577570 | T3436-00 G3436-01 |
| 222 | 343610308 | 4017807579673 | T3436-00 G3436-01 |
| 60 | 344110105 | 4017807577907 | T3441-00 |
| 60 | 344110165 | 4017807577860 | T3441-00 |
| 60 | 344110180 | 4017807579833 | T3441-00 |
| 260 | 3490400-00 | 4017807062465 | |
| 49 | 352710307 | 4017807453775 | T3527-00 92873IR |
| 49 | 352710342 | 4017807473308 | T3527-00 92873IR |
| 47 | 353810305 | 4017807574784 | T6538-00 92873IR |
| 260 | 3590010-01 | 4017807062496 | |
| 258 | 371010307 | 4017807281750 | 92734-01 |
| 258 | 371010308 | 4017807281767 | 92734-01 |
| 258 | 371010407 | 4017807281781 | 92734-01 |
| 258 | 371010408 | 4017807281798 | 92734-01 |
| 80 | 371310105 | 4017807445336 | |
| 80 | 371310131 | 4017807451801 | |
| 80 | 371310142 | 4017807445343 | |
| 259 | 3751031-07 | 4017807137729 | 9350 |
| 259 | 3751041-07 | 4017807137736 | 9350 |
| 259 | 3751051-07 | 4017807169027 | 9350 |

INDEX · NUMERIC

| Seite Page | Artikel-Nr. Product No. | EAN-Nummer EAN-Number | Ersatzteile Spare parts |
|---------------|----------------------------|--------------------------|--|
| 218 | 375310502 | 4017807504446 | T3753-00 |
| 218 | 375310505 | 4017807504439 | T3753-00 |
| 218 | 375310507 | 4017807472226 | T3753-00 |
| 218 | 375310508 | 4017807481839 | T3753-00 |
| 218 | 375310532 | 4017807472233 | T3753-00 |
| 221 | 375510407 | 4017807469844 | T3755-00 |
| 221 | 375510432 | 4017807469882 | T3755-00 |
| 220 | 379190707 | 4017807362831 | |
| 220 | 379190732 | 4017807471229 | |
| 389 | 400200107 | 4017807368390 | 92820-01 |
| 389 | 400200108 | 4017807378320 | 92820-01 |
| 388 | 400400107 | 4017807423211 | S4004-11 |
| 388 | 400400132 | 4017807423228 | S4004-11 |
| 158 | 401000224 | 4017807504712 | G4010-01 |
| 124 | 401100101 | 4017807276121 | 92782-01 |
| 124 | 401100102 | 4017807276138 | 92782-02 |
| 124 | 401100111 | 4017807505580 | S4011-11 |
| 192 | 401200101 | 4017807502640 | S3012-01 |
| 380 | 401700317 | 4017807502541 | S4017-01 S4017-02 S4017-11 F4017-02 |
| 198 | 401900367 | 4017807502619 | |
| 112 | 402000108 | 4017807436099 | G4020-01 |
| 111 | 402000132 | 4017807506426 | G4020-01 |
| 111 | 402000142 | 4017807433012 | G4020-54 |
| 205 | 402690167 | 4017807502688 | |
| 188 | 403000132 | 4017807468076 | |
| 140 | 403100317 | 4017807567786 | S5031-44 S4031-11 S4031-26 |
| 202 | 403400167 | 4017807426854 | |
| 394 | 403400317 | 4017807422986 | G40341-13 G40342-19 G40343-54 |
| 394 | 403400354 | 4017807422948 | G40341-54 G40342-54 G40343-54 |
| 427 | 4035011-04 | 4017807090604 | 92174 |
| 427 | 4035011-07 | 4017807090611 | 92174 |
| 427 | 4035011-08 | 4017807090628 | 92174 |
| 129 | 403900201 | 4017807433654 | S40391-01 S40392-01 |
| 129 | 403900208 | 4017807494556 | S40391-81 S40392-81 |
| 129 | 403900211 | 4017807433661 | S40391-11 S40392-11 |
| 209 | 404300332 | 4017807467727 | |
| 422 | 404600332 | 4017807377361 | |
| 183 | 405500367 | 4017807466751 | |
| 152 | 406700632 | 4017807364415 | |
| 393 | 407800132 | 4017807303216 | |
| 154 | 408000132 | 4017807407303 | |
| 136 | 408200179 | 4017807392593 | |
| 137 | 408290179 | 4017807392616 | |

| Seite Page | Artikel-Nr. Product No. | EAN-Nummer EAN-Number | Ersatzteile Spare parts |
|---------------|----------------------------|--------------------------|--|
| 118 | 408300307 | 4017807510676 | 92981-07 |
| 120 | 408300308 | 4017807510683 | 92981-08 |
| 106 | 408500542 | 4017807468670 | G40342-54 |
| 423 | 408800332 | 4017807390148 | |
| 123 | 409100307 | 4017807389654 | |
| 123 | 409100308 | 4017807389661 | |
| 101 | 411210406 | 4017807367836 | 92829-40 92833-10 92833-12 92833-14 |
| 134 | 411400132 | 4017807538618 | |
| 134 | 411400232 | 4017807538731 | |
| 130 | 411490132 | 4017807538687 | |
| 397 | 411700107 | 4017807575231 | S4117-07 F4117-32 |
| 397 | 411700108 | 4017807522501 | S4117-08 F4117-32 |
| 475 | 411900231 | 4017807523041 | |
| 147 | 411900232 | 4017807523058 | |
| 184 | 412300136 | 4017807561302 | S3123-36 |
| 424 | 412400107 | 4017807488777 | |
| 424 | 412400108 | 4017807488760 | |
| 424 | 412400131 | 4017807488784 | |
| 424 | 412400132 | 4017807488791 | |
| 206 | 412700132 | 4017807502732 | |
| 178 | 414300530 | 4017807538861 | |
| 382 | 414400107 | 4017807539448 | S4144-01 |
| 382 | 414400108 | 4017807539455 | S4144-01 |
| 382 | 414400132 | 4017807539486 | S4144-01 |
| 384 | 415700307 | 4017807539929 | S4157-01 |
| 384 | 415700332 | 4017807539950 | S4157-01 |
| 387 | 416900207 | 4017807541724 | S41691-07 S41692-07 |
| 387 | 416900208 | 4017807541717 | S41691-08 S41692-08 |
| 102 | 417000332 | 4017807581201 | G31701-57 G31702-57 G31703-57 |
| 142 | 419090144 | 4017807574159 | |
| 378 | 419200131 | 4017807574531 | S4192-11 F4192-31 |
| 378 | 419200141 | 4017807574524 | S4192-41 F4192-32 |
| 396 | 4200011-06 | 4017807105650 | 913244 |
| 421 | 420490107 | 4017807295337 | 9243-01 |
| 421 | 420490132 | 4017807382525 | 9243-01 |
| 413 | 420810107 | 4017807367614 | |
| 412 | 420910107 | 4017807367591 | |
| 412 | 420910108 | 4017807367607 | |
| 73 | 421210107 | 4017807454024 | T4212-01 |
| 73 | 421210108 | 4017807461169 | T4212-01 |
| 411 | 421910207 | 4017807267532 | 92685 92685-01 92754-01 |

| Seite Page | Artikel-Nr. Product No. | EAN-Nummer EAN-Number | Ersatzteile Spare parts |
|---------------|----------------------------|--------------------------|---|
| 411 | 421910228 | 4017807267549 | 92685 92685-01 92754-01 |
| 87 | 422610531 | 4017807423822 | T4226-00 T4226-0 T4226-01 T4226-02 |
| 87 | 422610532 | 4017807423853 | T4226-00 T4226-0 T4226-01 T4226-02 |
| 401 | 422710307 | 4017807343076 | |
| 401 | 422710308 | 4017807354270 | |
| 414 | 423310107 | 4017807505825 | |
| 414 | 423310108 | 4017807506105 | |
| 414 | 423310131 | 4017807588668 | |
| 414 | 423310132 | 4017807506099 | |
| 85 | 423410107 | 4017807506297 | T4234-00 |
| 85 | 423410131 | 4017807506310 | T4234-00 |
| 85 | 423410132 | 4017807506327 | T4234-00 |
| 406 | 424210304 | 4017807467635 | T4242-00 |
| 406 | 424210307 | 4017807467628 | T4242-00 |
| 406 | 424210332 | 4017807467598 | T4242-00 |
| 404 | 424310204 | 4017807525199 | T4243-00 |
| 404 | 424310207 | 4017807525182 | T4243-00 |
| 404 | 424310208 | 4017807525205 | T4243-00 |
| 404 | 424310232 | 4017807525212 | T4243-00 |
| 426 | 424810107 | 4017807257687 | 98249 |
| 426 | 424810207 | 4017807257700 | 98249 |
| 409 | 424910207 | 4017807353938 | 92928 |
| 402 | 425610204 | 4017807525243 | T4243-00 |
| 402 | 425610207 | 4017807525229 | T4243-00 T42561-00 |
| 402 | 425610208 | 4017807525250 | T4243-00 T42561-00 |
| 402 | 425610232 | 4017807525267 | T4243-00 T42561-00 |
| 71 | 426219107 | 4017807505276 | |
| 71 | 426219132 | 4017807505269 | |
| 174 | 426410130 | 4017807505450 | T4264-00 |
| 410 | 426410207 | 4017807244717 | |
| 410 | 426410208 | 4017807244724 | 92730 |
| 66 | 426510104 | 4017807525342 | T42652-00 |
| 66 | 426510107 | 4017807525335 | T42652-00 |
| 66 | 426510108 | 4017807525359 | T42652-00 |
| 66 | 426510142 | 4017807525366 | T42652-00 |
| 68 | 426510204 | 4017807525281 | T42651-00 |
| 68 | 426510207 | 4017807525274 | T42651-00 |
| 68 | 426510208 | 4017807525298 | T42651-00 |
| 68 | 426510242 | 4017807525311 | T42651-00 |
| 398 | 426511832 | 4017807467390 | T4265-02 |
| 78 | 426810132 | 4017807506501 | T42681-00 |
| 399 | 427511801 | 4017807274332 | 92777 |
| 399 | 427511802 | 4017807274349 | 92777 |
| 74 | 441210305 | 4017807540413 | T4412-00 |

| Seite Page | Artikel-Nr. Product No. | EAN-Nummer EAN-Number | Ersatzteile Spare parts |
|---------------|----------------------------|--------------------------|----------------------------|
| 74 | 441210308 | 4017807540390 | T4412-00 |
| 173 | 441610132 | 4017807542530 | T4416-00 |
| 65 | 441810205 | 4017807540765 | T4418-00 |
| 63 | 441810208 | 4017807541731 | T4418-00 |
| 158 | 4602021-24 | 4017807196801 | 92274 92274-01 |
| 124 | 461100101 | 4017807247220 | 92597-01 |
| 124 | 461100102 | 4017807247237 | 92597-02 |
| 124 | 461100111 | 4017807508673 | 92597-11 |
| 381 | 462100132 | 4017807398922 | S4621-02 |
| 416 | 470310104 | 4017807523348 | |
| 416 | 470310131 | 4017807523324 | |
| 416 | 470310132 | 4017807523331 | |
| 83 | 472910106 | 4017807299281 | |
| 459 | 473190307 | 4017807302691 | |
| 459 | 473190332 | 4017807382532 | |
| 392 | 474410179 | 4017807359633 | |
| 418 | 474790132 | 4017807390094 | |
| 390 | 475310307 | 4017807380439 | |
| 390 | 475310379 | 4017807380446 | 92844-79 |
| 407 | 478310206 | 4017807336795 | T4783-00 |
| 389 | 500200107 | 4017807368406 | |
| 389 | 500200108 | 4017807378313 | |
| 161 | 500700128 | 4017807354201 | 92809 |
| 158 | 501000224 | 4017807504729 | G5010-01 |
| 128 | 501100101 | 4017807246810 | |
| 128 | 501100102 | 4017807246827 | |
| 112 | 502000108 | 4017807436075 | G2020-01 |
| 110 | 502000132 | 4017807506402 | G2020-01 |
| 110 | 502000142 | 4017807432992 | G2020-54 |
| 194 | 502100130 | 4017807473476 | S30212-01 |
| 448 | 5027011-01 | 4017807017366 | |
| 448 | 5027011-17 | 4017807051360 | |
| 448 | 5027011-47 | 4017807124941 | |
| 446 | 5028010-01 | 4017807051414 | |
| 446 | 5028010-02 | 4017807051421 | |
| 446 | 5028010-17 | 4017807051438 | |
| 446 | 5028010-47 | 4017807051445 | |
| 449 | 5029010-01 | 4017807051377 | |
| 449 | 5029010-47 | 4017807051407 | |
| 141 | 503100144 | 4017807567793 | S5031-44 |
| 209 | 504300132 | 4017807467703 | |
| 445 | 504900104 | 4017807522570 | |
| 445 | 504900107 | 4017807522556 | |
| 445 | 504900131 | 4017807522518 | |
| 445 | 504900132 | 4017807522532 | |
| 428 | 505200112 | 4017807568790 | |
| 428 | 505200149 | 4017807568745 | |
| 428 | 505200177 | 4017807568776 | |
| 428 | 505200183 | 4017807568684 | |
| 429 | 506200131 | 4017807560831 | |
| 429 | 506200132 | 4017807560824 | |
| 429 | 506290131 | 4017807560879 | |
| 429 | 506290132 | 4017807560848 | |
| 154 | 508000132 | 4017807407280 | |

INDEX · NUMERIC

| Seite Page | Artikel-Nr. Product No. | EAN-Nummer EAN-Number | Ersatzteile Spare parts |
|---------------|----------------------------|--------------------------|----------------------------------|
| 136 | 508200179 | 4017807392555 | 92999 |
| 444 | 508300131 | 4017807422313 | |
| 444 | 508300132 | 4017807422337 | |
| 122 | 509100107 | 4017807398540 | S5091-01 |
| 122 | 509100108 | 4017807398557 | S5091-01 |
| 108 | 510600132 | 4017807427240 | G0106-54 |
| 108 | 510600154 | 4017807507522 | G0106-54 |
| 128 | 511100101 | 4017807246841 | S511100101 |
| 128 | 511100102 | 4017807246858 | 92807-02 |
| 100 | 511210306 | 4017807367829 | 92829-28 92833-10 92833-12 |
| 130 | 511400132 | 4017807538755 | |
| 475 | 511900131 | 4017807523072 | |
| 147 | 511900132 | 4017807523089 | |
| 186 | 512200136 | 4017807544831 | |
| 424 | 512400107 | 4017807488746 | |
| 424 | 512400108 | 4017807488753 | |
| 424 | 512400131 | 4017807488722 | |
| 424 | 512400132 | 4017807488739 | |
| 178 | 514300230 | 4017807538885 | |
| 382 | 514400107 | 4017807539301 | S5144-01 |
| 382 | 514400108 | 4017807539370 | S5144-01 |
| 382 | 514400132 | 4017807539400 | S5144-01 |
| 105 | 515190132 | 4017807539707 | G5151-57 |
| 384 | 515700107 | 4017807539882 | S5157-01 |
| 384 | 515700132 | 4017807539905 | S5157-01 |
| 384 | 515790107 | 4017807554977 | S51571-01 |
| 384 | 515790132 | 4017807554991 | S51571-01 |
| 142 | 519000144 | 4017807574142 | |
| 412 | 520910107 | 4017807367577 | T5209-00 |
| 412 | 520910108 | 4017807367584 | T5209-00 |
| 73 | 521210107 | 4017807454017 | T5212-00 |
| 73 | 521210108 | 4017807461152 | T5212-00 |
| 442 | 522520187 | 4017807226782 | |
| 87 | 522610331 | 4017807423792 | |
| 87 | 522610332 | 4017807423815 | |
| 441 | 523090131 | 4017807502503 | |
| 441 | 523090132 | 4017807502527 | |
| 414 | 523310107 | 4017807505771 | |
| 414 | 523310108 | 4017807505818 | |
| 414 | 523310131 | 4017807588675 | |
| 414 | 523310132 | 4017807505801 | |
| 434 | 525490106 | 4017807371710 | 92826 |
| 434 | 525490107 | 4017807371727 | 92826 |
| 432 | 525790107 | 4017807385663 | 92876 |
| 432 | 525790108 | 4017807385670 | 92876 |
| 68 | 526510104 | 4017807525373 | T5265-00 |
| 68 | 526510107 | 4017807510140 | T5265-00 |
| 68 | 526510108 | 4017807510157 | T5265-00 |
| 68 | 526510142 | 4017807510164 | T5265-00 |
| 78 | 526810132 | 4017807506471 | T52681-00 |
| 446 | 527090111 | 4017807372328 | |
| 446 | 527090131 | 4017807372335 | |
| 447 | 527290101 | 4017807291438 | |

| Seite Page | Artikel-Nr. Product No. | EAN-Nummer EAN-Number | Ersatzteile Spare parts |
|---------------|----------------------------|--------------------------|----------------------------|
| 447 | 527290102 | 4017807291445 | |
| 435 | 527590107 | 4017807371758 | 92825 |
| 435 | 527590179 | 4017807373103 | 92825 |
| 443 | 527690131 | 4017807372304 | |
| 443 | 527690132 | 4017807372311 | |
| 440 | 527920101 | 4017807276046 | |
| 440 | 527920102 | 4017807276053 | |
| 434 | 529690100 | 4017807262032 | 92671-00 |
| 434 | 529690107 | 4017807262070 | 92671-07 |
| 433 | 529990103 | 4017807248340 | 92584 |
| 433 | 529990107 | 4017807248364 | 92584 |
| 74 | 541210205 | 4017807540284 | T5412-00 |
| 74 | 541210208 | 4017807540253 | T5412-00 |
| 173 | 541610132 | 4017807542493 | T5416-00 |
| 65 | 541810205 | 4017807541748 | T5418-00 |
| 63 | 541810208 | 4017807541762 | T5418-00 |
| 95 | 542010107 | 4017807561395 | G3420-01 T3420-01 |
| 95 | 542010108 | 4017807561418 | G3420-01 T3420-01 |
| 96 | 542010132 | 4017807561456 | G3420-57 T3420-01 |
| 96 | 542010134 | 4017807561401 | G3420-01 T3420-01 |
| 416 | 570310104 | 4017807523294 | |
| 416 | 570310131 | 4017807523256 | |
| 416 | 570310132 | 4017807523270 | |
| 83 | 572910106 | 4017807303162 | |
| 459 | 573190107 | 4017807302677 | |
| 459 | 573190131 | 4017807302684 | |
| 392 | 574410179 | 4017807359626 | |
| 390 | 575310307 | 4017807380453 | |
| 390 | 575310379 | 4017807380460 | |
| 430 | 579790104 | 4017807275285 | T5797-00 |
| 430 | 579790107 | 4017807275322 | T5797-00 |
| 430 | 579790108 | 4017807275339 | T5797-00 |
| 430 | 579790132 | 4017807452549 | |
| 437 | 590100107 | 4017807551129 | 9424 |
| 437 | 590100132 | 4017807551136 | 9424 |
| 436 | 590200107 | 4017807551143 | 9426 |
| 436 | 590200132 | 4017807551150 | 9426 |
| 436 | 591000107 | 4017807551167 | 9262-01 |
| 436 | 591000132 | 4017807551174 | 9262-01 |
| 432 | 592300107 | 4017807551211 | 9309 |
| 138 | 595400101 | 4017807337778 | 93781 |
| 138 | 595400111 | 4017807337785 | 93781-11 |
| 138 | 595400179 | 4017807337792 | |
| 438 | 595700106 | 4017807551273 | 9610-01 |
| 438 | 595700107 | 4017807551280 | 9610-00 |
| 438 | 595700108 | 4017807551297 | 9610-00 |
| 439 | 599100106 | 4017807551303 | 92271-06 |
| 439 | 599100107 | 4017807551310 | 92271-07 |
| 439 | 599100108 | 4017807551327 | 92271-07 |
| 439 | 599100118 | 4017807551334 | 92271-18 |
| 439 | 599100124 | 4017807551341 | 92271-07 |

| Seite Page | Artikel-Nr. Product No. | EAN-Nummer EAN-Number | Ersatzteile Spare parts |
|---------------|----------------------------|--------------------------|------------------------------------|
| 438 | 599700101 | 4017807551358 | 92934-01 |
| 438 | 599700115 | 4017807551365 | |
| 438 | 599700119 | 4017807551372 | |
| 438 | 599700142 | 4017807551389 | |
| 160 | 600700328 | 4017807354225 | 92809 |
| 156 | 601000324 | 4017807504699 | G1010-01 |
| 116 | 601200100 | 4017807398601 | 92851 |
| 116 | 601200200 | 4017807398618 | 92852 |
| 198 | 601900467 | 4017807502596 | |
| 194 | 602100130 | 4017807491500 | S30211-01 C30211-01 |
| 117 | 602500101 | 4017807364941 | 92831-30 |
| 117 | 602500201 | 4017807364958 | 92831-40 |
| 140 | 603100244 | 4017807567748 | S60261-44 C60261-01 |
| 140 | 603100344 | 4017807567755 | S60262-44 C60262-01 |
| 140 | 603130317 | 4017807573817 | S6026-44 S60264-11 S60265-26 |
| 366 | 603300101 | 4017807433784 | |
| 90 | 603500331 | 4017807422047 | C6035-01 |
| 90 | 603500332 | 4017807422054 | C6035-01 |
| 126 | 603900301 | 4017807256536 | 92662 |
| 126 | 603900302 | 4017807256543 | 92662-02 |
| 126 | 603900311 | 4017807505627 | S60392-11 |
| 126 | 603900501 | 4017807369298 | 92631-65 |
| 126 | 603900502 | 4017807369304 | 92631-65 |
| 126 | 603900511 | 4017807505634 | S60393-11 92631-65 |
| 115 | 604400101 | 4017807364996 | 92830-30 |
| 115 | 604400201 | 4017807365009 | 92830-40 |
| 334 | 604900331 | 4017807454284 | |
| 334 | 604900332 | 4017807454307 | |
| 334 | 604900631 | 4017807454345 | |
| 334 | 604900632 | 4017807454369 | |
| 138 | 605400501 | 4017807349214 | 93781 |
| 138 | 605400511 | 4017807349221 | 93781-11 |
| 138 | 605400579 | 4017807349238 | 93781-79 |
| 182 | 605500467 | 4017807442588 | |
| 152 | 606700632 | 4017807373448 | |
| 341 | 606900132 | 4017807504170 | |
| 341 | 606900161 | 4017807351781 | |
| 341 | 606900162 | 4017807356823 | |
| 341 | 606903032 | 4017807512069 | |
| 341 | 606905032 | 4017807512038 | |
| 104 | 607601206 | 4017807426885 | G50761-54 |
| 340 | 608100224 | 4017807211795 | 92472-01 |
| 340 | 608100324 | 4017807211788 | 92472 |
| 136 | 608200279 | 4017807392531 | |
| 118 | 608300307 | 4017807510652 | 92980-01 92985-07 |
| 120 | 608300308 | 4017807510669 | 92980-01 92985-08 |
| 92 | 609800431 | 4017807387704 | 92887 |

| Seite Page | Artikel-Nr. Product No. | EAN-Nummer EAN-Number | Ersatzteile Spare parts |
|---------------|----------------------------|--------------------------|--|
| 92 | 609800432 | 4017807387711 | 92887 |
| 98 | 609900331 | 4017807330960 | 92943-01 |
| 98 | 609900332 | 4017807330984 | 92943 |
| 99 | 609900357 | 4017807573671 | G3099-57 |
| 344 | 6101011-01 | 4017807017557 | 9218-01 |
| 344 | 6101011-07 | 4017807028393 | 9218-01 |
| 158 | 6102021-24 | 4017807053296 | 92126 |
| 345 | 6105011-01 | 4017807053968 | 9285-01 |
| 345 | 6105021-01 | 4017807098440 | 9287-01 |
| 150 | 611100308 | 4017807537789 | |
| 150 | 611100367 | 4017807537642 | |
| 100 | 611210506 | 4017807367782 | 92829-40 92833-10 92833-12 92833-14 |
| 132 | 611400332 | 4017807538700 | |
| 134 | 611400532 | 4017807544572 | |
| 134 | 611490332 | 4017807544565 | |
| 196 | 611500201 | 4017807526158 | S61152-01 |
| 196 | 611500202 | 4017807526165 | S61152-02 |
| 196 | 611500301 | 4017807526202 | S61153-01 |
| 196 | 611500302 | 4017807526219 | S61153-02 |
| 148 | 611900632 | 4017807536584 | |
| 114 | 612200100 | 4017807522037 | G61221-52 |
| 114 | 612200200 | 4017807522051 | G61222-52 |
| 186 | 612200336 | 4017807544824 | |
| 184 | 612300236 | 4017807504637 | S6123-36 |
| 467 | 612400501 | 4017807411614 | |
| 467 | 612400504 | 4017807490619 | |
| 467 | 612400507 | 4017807411638 | |
| 467 | 612400532 | 4017807411621 | |
| 464 | 612400580 | 4017807523980 | |
| 342 | 612600230 | 4017807526325 | G6126-01 |
| 342 | 612600256 | 4017807526585 | G6126-01 |
| 337 | 612900131 | 4017807426441 | |
| 337 | 612900132 | 4017807426465 | |
| 337 | 612900134 | 4017807558876 | |
| 337 | 612900180 | 4017807558890 | |
| 337 | 612900231 | 4017807426526 | |
| 337 | 612900232 | 4017807426533 | |
| 337 | 612900431 | 4017807426588 | |
| 337 | 612900432 | 4017807426595 | |
| 339 | 613000131 | 4017807426908 | |
| 339 | 613000132 | 4017807426915 | |
| 339 | 613000134 | 4017807558913 | |
| 339 | 613000180 | 4017807558937 | |
| 339 | 613000231 | 4017807426922 | |
| 339 | 613000232 | 4017807426939 | |
| 339 | 613000431 | 4017807426977 | |
| 339 | 613000432 | 4017807426984 | |
| 178 | 614300430 | 4017807538939 | |
| 105 | 615190132 | 4017807539660 | G5151-57 |
| 190 | 615900232 | 4017807540321 | |
| 190 | 615900242 | 4017807540338 | |

INDEX · NUMERIC

| Seite Page | Artikel-Nr. Product No. | EAN-Nummer EAN-Number | Ersatzteile Spare parts |
|---------------|----------------------------|--------------------------|-----------------------------------|
| 293 | 616700306 | 4017807541687 | G61671-57 B61671-00 |
| 293 | 616700506 | 4017807541700 | G61672-57 B61672-00 |
| 142 | 619000244 | 4017807574128 | |
| 144 | 619430317 | 4017807574616 | |
| 344 | 6196011-01 | 4017807138238 | 9523-01 |
| 344 | 6196011-07 | 4017807138245 | 9523-07 |
| 278 | 620010407 | 4017807449525 | F6200-01 F6200-00 |
| 278 | 620010408 | 4017807550788 | F6200-00 F6200-01 |
| 278 | 620010431 | 4017807452204 | F6200-00 F6200-01 |
| 278 | 620010442 | 4017807449495 | F6200-01 |
| 76 | 620310307 | 4017807487862 | T6203-00 |
| 76 | 620310308 | 4017807487893 | T6203-00 |
| 76 | 620310331 | 4017807487879 | T6203-00 |
| 76 | 620310332 | 4017807487886 | T6203-00 |
| 284 | 620510307 | 4017807488586 | D62051-52 F6205-00 T6205-00 |
| 284 | 620510331 | 4017807488579 | D62051-52 F6205-00 T6205-00 |
| 284 | 620510332 | 4017807488562 | D62051-52 F6205-00 T6205-00 |
| 276 | 620710330 | 4017807562439 | 93790RD |
| 276 | 620710331 | 4017807562415 | 93790RD |
| 276 | 620710332 | 4017807562392 | 93790RD |
| 276 | 620710380 | 4017807562453 | 93790RD |
| 72 | 621210107 | 4017807453980 | T62121-00 |
| 72 | 621210108 | 4017807461121 | T62121-00 |
| 72 | 621290107 | 4017807453997 | T62122-00 |
| 72 | 621290108 | 4017807461138 | T62122-00 |
| 457 | 621410505 | 4017807220940 | 92426 |
| 81 | 621710107 | 4017807430509 | T6217-00 |
| 81 | 621710142 | 4017807430516 | T6217-00 |
| 320 | 621910317 | 4017807504019 | S6219-01 S6219-02 S6219-11 |
| 320 | 621911201 | 4017807337105 | F6205-00 |
| 320 | 621911211 | 4017807337112 | F6205-00 |
| 320 | 621912401 | 4017807337143 | F6205-00 |
| 320 | 621912411 | 4017807337150 | F6205-00 |
| 321 | 621914001 | 4017807384468 | 92883IR F6205-00 |
| 321 | 621914011 | 4017807384475 | 92883IR F6205-00 |
| 321 | 621915501 | 4017807384482 | F6205-00 92883IR T62193-00 |
| 321 | 621915511 | 4017807384499 | F6205-00 92883IR T62193-00 |

| Seite Page | Artikel-Nr. Product No. | EAN-Nummer EAN-Number | Ersatzteile Spare parts |
|---------------|----------------------------|--------------------------|---------------------------------|
| 86 | 622610431 | 4017807424270 | T6226-04 |
| 86 | 622610432 | 4017807424287 | T6226-04 |
| 86 | 622610531 | 4017807488821 | T6226-00 |
| 86 | 622610532 | 4017807488838 | T6226-00 |
| 164 | 622910332 | 4017807524994 | T6229-00 |
| 164 | 622910532 | 4017807524987 | T3229-00 |
| 85 | 623410207 | 4017807506235 | 92969RD T62341-00 |
| 85 | 623410231 | 4017807506242 | 92969RD T62341-00 |
| 85 | 623410232 | 4017807506259 | 92969RD T62341-00 |
| 85 | 623419207 | 4017807506266 | 92969RD T62342-00 |
| 85 | 623419231 | 4017807506273 | 92969RD T62342-00 |
| 85 | 623419232 | 4017807506280 | 92969RD T62342-00 |
| 180 | | 4017807451184 | |
| 355 | 624110279 | 4017807337051 | 92795 |
| 82 | 625010105 | 4017807422641 | T6250-00 |
| 304 | 625815031 | 4017807506457 | 92970RD |
| 70 | 626210107 | 4017807505191 | |
| 70 | 626210132 | 4017807505184 | |
| 174 | 626410530 | 4017807505429 | 92967RD 929671RD T6264-01 |
| 68 | 626510304 | 4017807538144 | T6265-00 |
| 68 | 626510307 | 4017807538083 | T6265-00 |
| 68 | 626510308 | 4017807538120 | T6265-00 |
| 68 | 626510342 | 4017807538168 | T6265-00 |
| 332 | 626510987 | 4017807245202 | |
| 332 | 626511287 | 4017807245226 | |
| 332 | 626512587 | 4017807246803 | |
| 175 | 626610232 | 4017807505498 | |
| 323 | 626910307 | 4017807506587 | 92996RD BATCN00020 |
| 323 | 626910332 | 4017807506594 | 92996RD BATCN00020 |
| 323 | 626919307 | 4017807506600 | 92996RD BATCN00020 |
| 323 | 626919332 | 4017807506617 | 92996RD BATCN00020 |
| 309 | 627413031 | 4017807525007 | T62741-00 |
| 309 | 627413032 | 4017807525014 | T62741-00 |
| 309 | 627413087 | 4017807525021 | T62741-00 |
| 309 | 627415031 | 4017807525038 | T62742-00 |
| 309 | 627415032 | 4017807525069 | T62742-00 |
| 309 | 627415087 | 4017807525076 | T62742-00 |
| 309 | 627417531 | 4017807525083 | T62743-00 |
| 309 | 627417532 | 4017807525090 | T62743-00 |
| 309 | 627417587 | 4017807525106 | T62743-00 |
| 330 | 627514000 | 4017807401837 | 6289IR-2 T62751-00 |

| Seite Page | Artikel-Nr. Product No. | EAN-Nummer EAN-Number | Ersatzteile Spare parts |
|---------------|----------------------------|--------------------------|-------------------------------------|
| 330 | 627516000 | 4017807401820 | 6289IR-2 T62752-00 BATCN00020 |
| 282 | 627710432 | 4017807442182 | |
| 282 | 627710532 | 4017807448184 | T62772-01 |
| 303 | 628410507 | 4017807504071 | 92975RD T6284-00 |
| 303 | 628410532 | 4017807504040 | 92975RD T6284-00 |
| 328 | 628513001 | 4017807298819 | |
| 328 | 628613001 | 4017807298826 | |
| 327 | 628915001 | 4017807272307 | 6289IR-2 |
| 306 | 629210331 | 4017807525113 | T6292-00 93000RD |
| 306 | 629219331 | 4017807525120 | T62921-00 93000RD |
| 88 | 640910131 | 4017807537901 | T6409-00 |
| 89 | 640910132 | 4017807537925 | T6409-00 |
| 166 | 641110231 | 4017807572131 | T64111-00 |
| 166 | 641110232 | 4017807572148 | T64111-00 |
| 166 | 641110331 | 4017807572155 | T64112-00 |
| 166 | 641110332 | 4017807572162 | T64112-00 |
| 74 | 641210305 | 4017807539936 | T6412-00 |
| 74 | 641210308 | 4017807539912 | T6412-00 |
| 310 | 641310208 | 4017807575019 | T6413-00 |
| 310 | 641310231 | 4017807574999 | T6413-00 |
| 310 | 641310232 | 4017807575002 | T6413-00 |
| 310 | 641310265 | 4017807575026 | T6413-00 |
| 294 | 641412106 | 4017807539288 | G6414-57 T6414-00 |
| 294 | 641412107 | 4017807539226 | G6414-01 T6414-00 |
| 294 | 641412132 | 4017807539257 | G64141-01 T6414-00 |
| 312 | 641510207 | 4017807574395 | 93801IR |
| 312 | 641510280 | 4017807574401 | 93801IR |
| 312 | 641519207 | 4017807574418 | 93801IR |
| 312 | 641519280 | 4017807574425 | 93801IR |
| 172 | 641610232 | 4017807542431 | T6416-00 |
| 64 | 641810205 | 4017807540741 | T6418-00 |
| 62 | 641810208 | 4017807540758 | T6418-00 |
| 266 | 641910205 | 4017807541939 | T6419-00 |
| 266 | 641910208 | 4017807541953 | T6419-00 |
| 274 | 642110331 | 4017807541830 | T6421-00 |
| 274 | 642110332 | 4017807541816 | T6421-00 |
| 274 | 642110431 | 4017807541908 | T64212-00 |
| 274 | 642110432 | 4017807541885 | T64212-00 |
| 268 | 642910280 | 4017807542974 | T64292-00 |
| 268 | 642910380 | 4017807542998 | T64293-00 |
| 273 | 643010306 | 4017807574739 | T6430-00 93799RD |
| 273 | 643010307 | 4017807574760 | T6430-00 93799RD |
| 273 | 643010332 | 4017807574746 | T6430-00 93799RD |

| Seite Page | Artikel-Nr. Product No. | EAN-Nummer EAN-Number | Ersatzteile Spare parts |
|---------------|----------------------------|--------------------------|----------------------------|
| 273 | 643010365 | 4017807574753 | T6430-00 93799RD |
| 168 | 643210332 | 4017807577075 | T64321-00 |
| 168 | 643210432 | 4017807577082 | T64322-00 |
| 170 | 643810232 | 4017807588446 | |
| 170 | 643810287 | 4017807588453 | |
| 170 | 643810332 | 4017807588415 | TH36591-00 |
| 170 | 643810387 | 4017807588439 | TH36591-00 |
| 170 | 643810432 | 4017807577051 | T6438-00 |
| 170 | 643810487 | 4017807577068 | T6438-00 |
| 60 | 644110105 | 4017807577914 | T6441-00 |
| 60 | 644110165 | 4017807577877 | T6441-00 |
| 60 | 644110180 | 4017807579840 | T6441-00 |
| 265 | 644810107 | 4017807580952 | T6448-00 |
| 265 | 644810132 | 4017807580945 | T6448-00 |
| 305 | 647110131 | 4017807575293 | T6471-00 93804RD |
| 514 | 650000106 | 4017807376210 | |
| 514 | 650000107 | 4017807376234 | |
| 514 | 650000108 | 4017807376241 | |
| 514 | 650000131 | 4017807376203 | |
| 514 | 650000132 | 4017807378061 | |
| 514 | 650000306 | 4017807376258 | |
| 514 | 650000307 | 4017807376265 | |
| 514 | 650000331 | 4017807376272 | |
| 514 | 650100106 | 4017807376302 | |
| 514 | 650100107 | 4017807376319 | |
| 514 | 650100108 | 4017807376326 | |
| 514 | 650100131 | 4017807376296 | |
| 514 | 650100132 | 4017807378078 | |
| 515 | 650100306 | 4017807376333 | |
| 515 | 650100307 | 4017807376340 | |
| 515 | 650100331 | 4017807376357 | |
| 511 | 650210106 | 4017807376388 | |
| 511 | 650210107 | 4017807376395 | |
| 511 | 650210131 | 4017807376371 | |
| 511 | 650310106 | 4017807376463 | |
| 511 | 650310107 | 4017807376470 | |
| 511 | 650310131 | 4017807376456 | |
| 509 | 650410106 | 4017807376630 | |
| 509 | 650410107 | 4017807376647 | |
| 509 | 650410131 | 4017807376623 | |
| 509 | 650410132 | 4017807378030 | |
| 509 | 650510106 | 4017807376753 | |
| 509 | 650510107 | 4017807376760 | |
| 509 | 650510131 | 4017807376722 | |
| 509 | 650510132 | 4017807378085 | |
| 508 | 650610106 | 4017807376869 | |
| 508 | 650610107 | 4017807376876 | |
| 508 | 650610131 | 4017807376890 | |
| 508 | 650610132 | 4017807442595 | |
| 508 | 650710106 | 4017807376937 | |
| 508 | 650710107 | 4017807376944 | |
| 508 | 650710131 | 4017807376951 | |
| 508 | 650710132 | 4017807442601 | |

596

597

INDEX · NUMERIC

| Seite Page | Artikel-Nr. Product No. | EAN-Nummer EAN-Number | Ersatzteile Spare parts |
|---------------|----------------------------|--------------------------|----------------------------|
| 455 | 651000107 | 4017807573947 | |
| 455 | 651000131 | 4017807573923 | |
| 455 | 651000132 | 4017807573930 | |
| 455 | 651000207 | 4017807573978 | |
| 455 | 651000231 | 4017807573954 | |
| 455 | 651000232 | 4017807573961 | |
| 455 | 651000307 | 4017807574005 | |
| 455 | 651000331 | 4017807573985 | |
| 455 | 651000332 | 4017807573992 | |
| 53 | 651210507 | 4017807389753 | |
| 512 | 651500131 | 4017807455915 | |
| 512 | 651500132 | 4017807455939 | |
| 512 | 651600131 | 4017807455946 | |
| 512 | 651600132 | 4017807455977 | |
| 512 | 651600231 | 4017807456011 | |
| 512 | 651600232 | 4017807455991 | |
| 510 | 651700152 | 4017807425888 | |
| 510 | 651800152 | 4017807425901 | |
| 57 | 651914001 | 4017807389609 | |
| 57 | 651915501 | 4017807389616 | |
| 510 | 652100152 | 4017807425925 | |
| 510 | 652200152 | 4017807425949 | |
| 504 | 652310106 | 4017807427660 | |
| 504 | 652310131 | 4017807427677 | |
| 504 | 652310132 | 4017807504095 | |
| 504 | 652410106 | 4017807427684 | |
| 504 | 652410131 | 4017807427691 | |
| 504 | 652410132 | 4017807504101 | |
| 505 | 652510106 | 4017807427707 | |
| 505 | 652510131 | 4017807427714 | |
| 505 | 652510132 | 4017807504132 | |
| 505 | 652610106 | 4017807427721 | |
| 505 | 652610131 | 4017807427738 | |
| 505 | 652610132 | 4017807504156 | |
| 50 | 652610307 | 4017807453881 | T65261-00 92873IR |
| 50 | 652610342 | 4017807453751 | T65261-00 92873IR |
| 51 | 652690307 | 4017807453898 | T65269-00 |
| 51 | 652690342 | 4017807453768 | T65269-00 |
| 48 | 652710307 | 4017807453799 | T6527-00 92873IR |
| 48 | 652710342 | 4017807473339 | T6527-00 92873IR |
| 452 | 652910131 | 4017807473643 | |
| 452 | 652910132 | 4017807473650 | |
| 452 | 652910231 | 4017807473667 | |
| 452 | 652910232 | 4017807473674 | |
| 452 | 652910331 | 4017807473681 | |
| 452 | 652910332 | 4017807473698 | |
| 506 | 653410106 | 4017807574432 | |
| 506 | 653410131 | 4017807574449 | |
| 506 | 653410132 | 4017807574456 | |
| 507 | 653610106 | 4017807574463 | 93800IR |
| 507 | 653610131 | 4017807574487 | 93800IR |

| Seite Page | Artikel-Nr. Product No. | EAN-Nummer EAN-Number | Ersatzteile Spare parts |
|---------------|----------------------------|--------------------------|----------------------------|
| 507 | 653610132 | 4017807574500 | 93800IR |
| 507 | 653610306 | 4017807574470 | 93800IR |
| 507 | 653610331 | 4017807574494 | 93800IR |
| 507 | 653610332 | 4017807574517 | 93800IR |
| 46 | 653810305 | 4017807574777 | T6538-00 92873IR |
| 56 | 656010100 | 4017807389845 | |
| 56 | 656090100 | 4017807389869 | |
| 333 | 656411506 | 4017807371796 | |
| 333 | 656412406 | 4017807371802 | |
| 333 | 656511806 | 4017807371826 | |
| 333 | 656512006 | 4017807371833 | |
| 54 | 657411107 | 4017807436358 | |
| 54 | 657414007 | 4017807434521 | T65741-20 |
| 54 | 657416007 | 4017807434552 | T65741-36 92873IR |
| 547 | 659011801 | 4017807280081 | |
| 547 | 659011806 | 4017807508413 | |
| 547 | 659011832 | 4017807508406 | |
| 547 | 659011887 | 4017807280098 | |
| 540 | 659411806 | 4017807280050 | |
| 540 | 659412406 | 4017807280074 | |
| 290 | 670710507 | 4017807503470 | 92975RD T6707-00 |
| 290 | 670710532 | 4017807503456 | 92975RD T6707-00 |
| 291 | 670810607 | 4017807503531 | 92975RD T6708-00 |
| 291 | 670810632 | 4017807503524 | 92975RD T6708-00 |
| 314 | 671210131 | 4017807489835 | T67121-00 |
| 314 | 671210132 | 4017807489842 | T67121-00 |
| 315 | 671290131 | 4017807489859 | 92960RD T67122-00 |
| 315 | 671290132 | 4017807489866 | 92960RD T67122-00 |
| 80 | 671310105 | 4017807445329 | |
| 80 | 671310131 | 4017807451832 | |
| 80 | 671310142 | 4017807445312 | |
| 298 | 671610307 | 4017807391237 | |
| 298 | 671610331 | 4017807391244 | |
| 283 | 672110505 | 4017807503982 | T6721-00 |
| 283 | 672110542 | 4017807503951 | T6721-00 |
| 285 | 672310207 | 4017807503371 | 92966RD T6723-00 |
| 285 | 672310232 | 4017807503357 | 92966RD T6723-00 |
| 281 | 672610332 | 4017807441208 | |
| 83 | 672910106 | 4017807299274 | T6729-00 |
| 280 | 673210306 | 4017807388411 | |
| 280 | 673210332 | 4017807441192 | |
| 297 | 673311306 | 4017807358407 | F6200-01 |
| 270 | 673810206 | 4017807433333 | |
| 270 | 673810232 | 4017807433364 | |
| 271 | 673810306 | 4017807505689 | |

| Seite Page | Artikel-Nr. Product No. | EAN-Nummer EAN-Number | Ersatzteile Spare parts |
|---------------|----------------------------|--------------------------|---|
| 271 | 673810332 | 4017807505702 | |
| 270 | 673890206 | 4017807433371 | |
| 270 | 673890232 | 4017807433388 | |
| 286 | 673916007 | 4017807452594 | T6739-00 |
| 286 | 673916031 | 4017807452235 | T6739-00 |
| 286 | 673916032 | 4017807441437 | T6739-00 |
| 286 | 673918007 | 4017807452617 | T67391-00 |
| 286 | 673918031 | 4017807452259 | T67391-00 |
| 286 | 673918032 | 4017807441468 | T67391-00 |
| 319 | 674011207 | 4017807363708 | |
| 317 | 674011232 | 4017807556315 | |
| 318 | 674013007 | 4017807363630 | |
| 316 | 674013032 | 4017807556322 | |
| 319 | 674014507 | 4017807363654 | |
| 317 | 674014532 | 4017807556339 | |
| 319 | 674016207 | 4017807363692 | |
| 317 | 674016232 | 4017807556346 | |
| 318 | 674093007 | 4017807363623 | |
| 316 | 674093032 | 4017807556353 | |
| 318 | 674094507 | 4017807363647 | |
| 316 | 674094532 | 4017807556360 | |
| 318 | 674096207 | 4017807363685 | |
| 316 | 674096232 | 4017807556377 | |
| 299 | 674410331 | 4017807477108 | T6744-00 |
| 300 | 674610507 | 4017807385786 | T67465-00 |
| 300 | 674610532 | 4017807575118 | T67465-00 |
| 301 | 674610707 | 4017807450224 | T67467-00 |
| 325 | 675610106 | 4017807363302 | 92870RD 6289IR-2 92863-241 T6756-00 |
| 288 | 676210307 | 4017807371918 | |
| 288 | 676210342 | 4017807425703 | |
| 288 | 676210407 | 4017807425734 | |
| 288 | 676210442 | 4017807425758 | |
| 289 | 676240331 | 4017807524901 | T67623-00 |
| 289 | 676240431 | 4017807524949 | T67624-00 |
| 322 | 676611031 | 4017807398533 | 93787RD T67663-00 92868RD BATCN00020 |
| 322 | 676615031 | 4017807398519 | 93787RD 92868RD BATCN00020 CAP01F250 |
| 322 | 676617531 | 4017807398526 | 93787RD 92868RD BATCN00020 CAP01F250 |
| 329 | 677718000 | 4017807337686 | 92804 T6777-00 |
| 326 | 678513001 | 4017807431070 | 6289IR-2 |
| 324 | 678710006 | 4017807337730 | T6756-00 6289IR-2 6787IR |

| Seite Page | Artikel-Nr. Product No. | EAN-Nummer EAN-Number | Ersatzteile Spare parts |
|---------------|----------------------------|--------------------------|--|
| 324 | 678711206 | 4017807337716 | |
| 324 | 678713006 | 4017807337723 | 6787IR 6289IR-2 |
| 331 | 679210106 | 4017807440348 | 6289IR-2 |
| 296 | 679511532 | 4017807450767 | T6795-00 |
| 545 | 6801011-01 | 4017807259056 | |
| 545 | 6801011-06 | 4017807147575 | 9580 |
| 545 | 6801011-07 | 4017807147582 | 9580 |
| 545 | 6801011-32 | 4017807507690 | |
| 543 | 680213500 | 4017807508475 | 92930-35 92974IR |
| 543 | 680214800 | 4017807508482 | 92930-48 92974IR |
| 541 | 680310106 | 4017807508437 | |
| 541 | 680310132 | 4017807508444 | |
| 541 | 680319106 | 4017807508451 | |
| 541 | 680319132 | 4017807508468 | |
| 546 | 680710106 | 4017807507843 | |
| 546 | 680710131 | 4017807507867 | |
| 546 | 680710132 | 4017807507881 | |
| 534 | 680810306 | 4017807508505 | T68081-00 |
| 534 | 680810332 | 4017807508512 | T68081-00 |
| 534 | 680819306 | 4017807508529 | T68082-00 |
| 534 | 680819332 | 4017807508536 | T68082-00 |
| 518 | 682410506 | 4017807280845 | |
| 542 | 686014000 | 4017807507744 | E6260-00 T6860-00 |
| 542 | 686014001 | 4017807507720 | E6260-00 T6860-00 |
| 539 | 686412406 | 4017807507805 | |
| 539 | 686512406 | 4017807507829 | |
| 538 | 689214032 | 4017807507768 | |
| 538 | 689314032 | 4017807507782 | |
| 127 | 693900417 | 4017807409451 | S693915-11 S693920-02 S693925-01 S693930-01 |
| 127 | 693900517 | 4017807399547 | S693920-11 S693925-02 S693930-02 S693935-01 |
| 484 | 700131 | 4017807470161 | |
| 484 | 700132 | 4017807470178 | |
| 484 | 700187 | 4017807470246 | |
| 484 | 700231 | 4017807470277 | |
| 484 | 700232 | 4017807470307 | |
| 484 | 700287 | 4017807470253 | |
| 484 | 700331 | 4017807591033 | |
| 484 | 700332 | 4017807591057 | |
| 484 | 700387 | 4017807591071 | |
| 485 | 701031 | 4017807470321 | |
| 485 | 701032 | 4017807470338 | |
| 485 | 701087 | 4017807470345 | |
| 485 | 701131 | 4017807474824 | |
| 485 | 701132 | 4017807474831 | |

INDEX · NUMERIC

| Seite Page | Artikel-Nr. Product No. | EAN-Nummer EAN-Number | Ersatzteile Spare parts |
|---------------|----------------------------|--------------------------|----------------------------|
| 485 | 701187 | 4017807474848 | |
| 491 | 701231 | 4017807470352 | |
| 491 | 701232 | 4017807470369 | |
| 491 | 701287 | 4017807470376 | |
| 486 | 702031 | 4017807470383 | |
| 486 | 702032 | 4017807470390 | |
| 486 | 702087 | 4017807470406 | |
| 486 | 702131 | 4017807470475 | |
| 486 | 702132 | 4017807470482 | |
| 486 | 702187 | 4017807470499 | |
| 486 | 702231 | 4017807470505 | |
| 486 | 702231A | 4017807474855 | |
| 486 | 702232 | 4017807470543 | |
| 486 | 702232A | 4017807474862 | |
| 486 | 702287 | 4017807470550 | |
| 486 | 702287A | 4017807474879 | |
| 487 | 702331 | 4017807470567 | |
| 487 | 702331A | 4017807482171 | |
| 487 | 702331B | 4017807518900 | |
| 487 | 702332 | 4017807470574 | |
| 487 | 702332A | 4017807482188 | |
| 487 | 702332B | 4017807518924 | |
| 487 | 702387 | 4017807470581 | |
| 487 | 702387A | 4017807482195 | |
| 487 | 702387B | 4017807518948 | |
| 487 | 702431 | 4017807470598 | |
| 487 | 702432 | 4017807470604 | |
| 487 | 702487 | 4017807470611 | |
| 491 | 702531 | 4017807470628 | |
| 491 | 702532 | 4017807470635 | |
| 491 | 702587 | 4017807470642 | |
| 490 | 703031 | 4017807471397 | |
| 490 | 703032 | 4017807471403 | |
| 490 | 703087 | 4017807471410 | |
| 490 | 703131 | 4017807471427 | |
| 490 | 703132 | 4017807471434 | |
| 490 | 703187 | 4017807471441 | |
| 490 | 703231 | 4017807471458 | |
| 490 | 703232 | 4017807471465 | |
| 490 | 703287 | 4017807471472 | |
| 489 | 703331 | 4017807471489 | |
| 489 | 703332 | 4017807471502 | |
| 489 | 703387 | 4017807471519 | |
| 491 | 703431 | 4017807474886 | |
| 489 | 703531 | 4017807474893 | |
| 489 | 703532 | 4017807474909 | |
| 489 | 703587 | 4017807474916 | |
| 489 | 703631 | 4017807577471 | |
| 489 | 703632 | 4017807577488 | |
| 489 | 703687 | 4017807577495 | |
| 490 | 703731 | 4017807591101 | |
| 490 | 703732 | 4017807591118 | |
| 490 | 703787 | 4017807591125 | |
| 484 | 703809 | 4017807577525 | |
| 491 | 703952 | 4017807471533 | |

| Seite Page | Artikel-Nr. Product No. | EAN-Nummer EAN-Number | Ersatzteile Spare parts |
|---------------|----------------------------|--------------------------|----------------------------|
| 495 | 73043107 | 4017807505955 | T7304-00 |
| 495 | 73043131 | 4017807505931 | T7304-00 |
| 495 | 73043132 | 4017807505948 | T7304-00 |
| 496 | 73060132 | 4017807577518 | G0106-54 |
| 500 | 73120102 | 4017807471557 | |
| 494 | 73240107 | 4017807471564 | |
| 494 | 73240108 | 4017807542684 | |
| 494 | 73240131 | 4017807471571 | |
| 494 | 73240132 | 4017807471588 | |
| 500 | 73330101 | 4017807471595 | |
| 500 | 73330111 | 4017807471618 | |
| 497 | 73430132 | 4017807506037 | |
| 496 | 73520101 | 4017807471656 | |
| 496 | 73700132 | 4017807577501 | G31702-57 |
| 501 | 73820180 | 4017807505856 | |
| 500 | 76390201 | 4017807472110 | |
| 500 | 76390211 | 4017807472127 | |
| 501 | 76820280 | 4017807505832 | |
| 498 | 76921031 | 4017807505962 | T76921-00 |
| 498 | 76921032 | 4017807505979 | T76921-00 |
| 498 | 76921087 | 4017807505986 | T76921-00 |
| 498 | 76921531 | 4017807505993 | T76922-00 |
| 498 | 76921532 | 4017807506006 | T76922-00 |
| 498 | 76921587 | 4017807506013 | T76922-00 |
| 498 | 77020131 | 4017807472028 | |
| 498 | 77020132 | 4017807472035 | |
| 498 | 77020187 | 4017807472042 | |
| 497 | 78010107 | 4017807471946 | |
| 497 | 78010131 | 4017807471922 | |
| 497 | 78010132 | 4017807471939 | |
| 492 | 78030131 | 4017807505900 | T7803-00 |
| 492 | 78030132 | 4017807505917 | T7803-00 |
| 492 | 78030187 | 4017807505924 | T7803-00 |
| 492 | 78070107 | 4017807472073 | |
| 492 | 78070131 | 4017807472080 | |
| 492 | 78070132 | 4017807472103 | |
| 492 | 78150107 | 4017807505894 | T7815-00 |
| 492 | 78150131 | 4017807505870 | T7815-00 |
| 492 | 78150132 | 4017807505887 | T7815-00 |
| 496 | 78170107 | 4017807471663 | |
| 494 | 78240107 | 4017807471694 | |
| 494 | 78240108 | 4017807542660 | |
| 494 | 78240131 | 4017807471700 | |
| 494 | 78240132 | 4017807471724 | |
| 500 | 78330101 | 4017807471977 | |
| 500 | 78330111 | 4017807471991 | |
| 500 | 78330179 | 4017807472295 | |
| 497 | 78430132 | 4017807506020 | |
| 468 | 800700132 | 4017807469141 | |
| 468 | 800700232 | 4017807469226 | |
| 468 | 800700332 | 4017807469301 | |
| 468 | 800700432 | 4017807469363 | |
| 176 | 801100231 | 4017807562316 | |
| 176 | 801100232 | 4017807562217 | |
| 176 | 801100331 | 4017807565676 | |

| Seite Page | Artikel-Nr. Product No. | EAN-Nummer EAN-Number | Ersatzteile Spare parts |
|---------------|----------------------------|--------------------------|----------------------------|
| 176 | 801100332 | 4017807562231 | |
| 176 | 801170131 | 4017807585315 | |
| 176 | 801170132 | 4017807585339 | |
| 198 | 801900167 | 4017807502558 | |
| 198 | 801900267 | 4017807502565 | |
| 198 | 801900367 | 4017807502589 | |
| 466 | 802400101 | 4017807227543 | |
| 466 | 802400104 | 4017807490534 | |
| 466 | 802400107 | 4017807231335 | |
| 466 | 802400124 | 4017807408621 | |
| 466 | 802400132 | 4017807408614 | |
| 464 | 802400180 | 4017807523898 | |
| 466 | 802400201 | 4017807227550 | |
| 466 | 802400204 | 4017807490558 | |
| 466 | 802400207 | 4017807231359 | |
| 466 | 802400224 | 4017807408645 | |
| 466 | 802400232 | 4017807408638 | |
| 464 | 802400280 | 4017807523911 | |
| 466 | 802400301 | 4017807227567 | |
| 466 | 802400304 | 4017807490572 | |
| 466 | 802400307 | 4017807231373 | |
| 466 | 802400324 | 4017807408669 | |
| 466 | 802400332 | 4017807408652 | |
| 464 | 802400380 | 4017807523935 | |
| 466 | 802430401 | 4017807227574 | |
| 466 | 802430404 | 4017807490596 | |
| 466 | 802430407 | 4017807231397 | |
| 466 | 802430424 | 4017807408683 | |
| 466 | 802430432 | 4017807408676 | |
| 464 | 802430480 | 4017807523959 | |
| 470 | 803000107 | 4017807348262 | |
| 470 | 803000207 | 4017807348279 | |
| 470 | 803000307 | 4017807348286 | |
| 470 | 803090307 | 4017807348323 | |
| 202 | 803400167 | 4017807430196 | |
| 202 | 803400267 | 4017807430202 | |
| 202 | 803400367 | 4017807430219 | |
| 471 | 803500131 | 4017807408201 | S8035-02 |
| 471 | 803500132 | 4017807408225 | S8035-02 |
| 471 | 803500231 | 4017807408232 | S8035-02 |
| 471 | 803500232 | 4017807408249 | S8035-02 |
| 471 | 803500331 | 4017807408256 | S8035-02 |
| 471 | 803500332 | 4017807408263 | S8035-02 |
| 208 | 804300332 | 4017807467666 | |
| 208 | 804300432 | 4017807467680 | |
| 208 | 804370132 | 4017807467604 | |
| 208 | 804370232 | 4017807467642 | |
| 210 | 805300188 | 4017807445183 | |
| 210 | 805300288 | 4017807445190 | |
| 210 | 805300388 | 4017807445206 | |
| 210 | 805300488 | 4017807445213 | |
| 132 | 811400132 | 4017807538335 | |
| 132 | 811400232 | 4017807538359 | |
| 132 | 811400432 | 4017807538397 | |
| 132 | 811430332 | 4017807538373 | |

| Seite Page | Artikel-Nr. Product No. | EAN-Nummer EAN-Number | Ersatzteile Spare parts |
|---------------|----------------------------|--------------------------|-------------------------------|
| 474 | 811900131 | 4017807522815 | |
| 148 | 811900132 | 4017807522792 | |
| 474 | 811900231 | 4017807522860 | |
| 148 | 811900232 | 4017807522877 | |
| 474 | 811900331 | 4017807522921 | |
| 148 | 811900332 | 4017807522938 | |
| 462 | 812400107 | 4017807487947 | |
| 462 | 812400131 | 4017807487961 | |
| 462 | 812400132 | 4017807487954 | |
| 462 | 812400207 | 4017807487978 | |
| 462 | 812400231 | 4017807487992 | |
| 462 | 812400232 | 4017807487985 | |
| 462 | 812400307 | 4017807488005 | |
| 462 | 812400331 | 4017807488029 | |
| 462 | 812400332 | 4017807488012 | |
| 462 | 812400407 | 4017807488036 | |
| 462 | 812400431 | 4017807488067 | |
| 462 | 812400432 | 4017807488043 | |
| 476 | 813400127 | 4017807540789 | |
| 476 | 813400227 | 4017807540833 | |
| 476 | 813400427 | 4017807540857 | |
| 476 | 813430327 | 4017807540864 | |
| 456 | 821410305 | 4017807220902 | 92426 92426-35 959-745 |
| 456 | 821410405 | 4017807220919 | 92426 92426-35 959-745 |
| 456 | 821410605 | 4017807220933 | 92426 92426-35 959-745 |
| 457 | 821430405 | 4017807220926 | 92426 92426-35 959-745 |
| 457 | 821470105 | 4017807220889 | 92426 92426-35 959-745 |
| 456 | 821470205 | 4017807220896 | 92426 92426-35 92389-01 |
| 473 | 871010107 | 4017807281637 | 92734 |
| 473 | 871010108 | 4017807281644 | 92734 |
| 472 | 871010207 | 4017807281651 | 92734 |
| 472 | 871010208 | 4017807281668 | 92734 |
| 472 | 871010307 | 4017807281675 | 92734 |
| 472 | 871010308 | 4017807281682 | 92734 |
| 472 | 871010407 | 4017807281712 | 92734 |
| 472 | 871010408 | 4017807281729 | 92734 |
| 472 | 871010607 | 4017807281736 | 92734 |
| 472 | 871010608 | 4017807281743 | 92734 |
| 473 | 871090307 | 4017807281699 | 92734 |
| 473 | 871090308 | 4017807281705 | 92734 |
| 458 | 873110307 | 4017807302615 | T87313-00 |
| 458 | 873110331 | 4017807302622 | T87313-00 |
| 458 | 873110407 | 4017807302639 | T87314-00 |

| Seite Page | Artikel-Nr. Product No. | EAN-Nummer EAN-Number | Ersatzteile Spare parts | Seite Page | Artikel-Nr. Product No. | EAN-Nummer EAN-Number | Ersatzteile Spare parts |
|---------------|----------------------------|--------------------------|----------------------------|---------------|----------------------------|--------------------------|----------------------------|
| 458 | 873110431 | 4017807302646 | T87314-00 | 555 | 986-4813 | 4017807586725 | |
| 459 | 873110607 | 4017807302653 | | 554 | 986-60 | 4017807280647 | |
| 459 | 873110631 | 4017807302660 | | 554 | 986-63 | 4017807280654 | |
| 458 | 873170107 | 4017807302578 | | 556 | 986-6790 | 4017807509120 | |
| 458 | 873170131 | 4017807302585 | | 556 | 986-6810 | 4017807358766 | |
| 458 | 873170207 | 4017807302592 | | 557 | 986-710 | 4017807433463 | |
| 458 | 873170231 | 4017807302608 | | 555 | 987-2400 | 4017807303933 | |
| 536 | 880400106 | 4017807508031 | | 555 | 987-2479 | 4017807509113 | |
| 536 | 880400132 | 4017807508048 | | 554 | 987-260 | 4017807509090 | |
| 536 | 880400406 | 4017807508383 | | 554 | 987-400 | 4017807287509 | |
| 536 | 880400432 | 4017807508390 | | 555 | 987-410 | 4017807394917 | |
| 536 | 880430306 | 4017807508369 | | 555 | 987-479 | 4017807509106 | |
| 536 | 880430332 | 4017807508376 | | 557 | 987-4813 | 4017807579123 | |
| 370 | 891010107 | 4017807358049 | 92734 | 554 | 987-60 | 4017807279252 | |
| 370 | 8911211-07 | 4017807118780 | | 557 | 987-600 | 4017807288056 | |
| 558 | 901-479 | 4017807351446 | | 555 | 987-6700 | 4017807387636 | |
| 558 | 902-479 | 4017807351453 | | 557 | 987-679 | 4017807288049 | |
| 558 | 903-479 | 4017807351460 | | 554 | 987-6810 | 4017807358735 | |
| 558 | 904-479 | 4017807351477 | | 554 | 987-7009 | 4017807508949 | |
| 562 | 929-220 | 4017807293319 | | 555 | 987-740 | 4017807579079 | |
| 562 | 929-230 | 4017807355000 | | 554 | 987-909 | 4017807508956 | |
| 562 | 929-2300 | 4017807394924 | | 554 | 988-10 | 4017807300338 | |
| 211 | 92945 | 4017807478174 | | 554 | 988-110 | 4017807394894 | |
| 563 | 955-50 | 4017807277074 | | 557 | 988-4813 | 4017807579147 | |
| 561 | 955-55 | 4017807277098 | | 556 | 988-600 | 4017807287516 | |
| 562 | 956-30 | 4017807277050 | | 556 | 988-679 | 4017807287530 | |
| 562 | 956-330 | 4017807509151 | | 554 | 988-700 | 4017807394887 | |
| 562 | 956-355 | 4017807509144 | | 557 | 988-710 | 4017807433449 | |
| 562 | 956-44 | 4017807579062 | | 556 | 988-901 | 4017807579093 | |
| 562 | 956-509 | 4017807508987 | | 560 | 989-200 | 4017807508864 | |
| 563 | 956-55 | 4017807300369 | | 560 | 989-279 | 4017807508871 | |
| 563 | 956-5736 | 4017807380057 | | 560 | 989-3200 | 4017807508918 | |
| 563 | 956-5936 | 4017807380071 | | 560 | 989-3279 | 4017807508925 | |
| 560 | 983-200 | 4017807508840 | | 560 | 989-3400 | 4017807543162 | |
| 560 | 983-279 | 4017807508857 | | 559 | 989-40 | 4017807240597 | |
| 561 | 983-3200 | 4017807508901 | | 560 | 989-400 | 4017807287486 | |
| 561 | 983-3279 | 4017807508932 | | 559 | 989-43 | 4017807260557 | |
| 561 | 983-3400 | 4017807543155 | | 560 | 989-4470 | 4017807358926 | |
| 559 | 983-40 | 4017807240566 | | 560 | 989-479 | 4017807287523 | |
| 560 | 983-400 | 4017807302097 | | 560 | 989-4790 | 4017807509083 | |
| 560 | 983-410 | 4017807394900 | | 559 | 989-509 | 4017807508970 | |
| 559 | 983-43 | 4017807260540 | | 559 | 989-56 | 4017807394870 | |
| 561 | 983-440 | 4017807579086 | | 559 | 989-60 | 4017807279238 | |
| 561 | 983-4470 | 4017807358940 | | 559 | 989-63 | 4017807279245 | |
| 560 | 983-479 | 4017807530612 | | 559 | 989-66 | 4017807300352 | |
| 561 | 983-4790 | 4017807509137 | | 560 | 990-200 | 4017807508895 | |
| 561 | 983-4813 | 4017807579109 | | 560 | 990-279 | 4017807508888 | |
| 559 | 983-509 | 4017807508963 | | 559 | 990-40 | 4017807240610 | |
| 559 | 983-56 | 4017807394863 | | 560 | 990-400 | 4017807287493 | |
| 559 | 983-60 | 4017807279214 | | 560 | 990-4470 | 4017807358933 | |
| 559 | 983-63 | 4017807279221 | | 560 | 990-4790 | 4017807509076 | |
| 559 | 983-66 | 4017807300345 | | | | | |
| 556 | 985-6810 | 4017807358759 | | | | | |
| 554 | 986-40 | 4017807268782 | | | | | |
| 554 | 986-43 | 4017807268799 | | | | | |

Warranty Statement · Déclaration de garantie · Garantieverklaring · Declaración de garantía · Dichiarazione di garanzia · Declarație de garanție · Takuuehdot · Oświadczenie o gwarancji



(D) Als innovatives und zukunftsorientiertes Unternehmen legen wir großen Wert auf die Qualität und Zuverlässigkeit unserer Produkte. Alle unsere Sortimentsartikel unterliegen einer strengen Qualitätskontrolle. Sollte ein Produkt wider Erwarten nicht einwandfrei funktionieren oder Mängel aufweisen, übernehmen wir gegenüber Verbrauchern für alle LED-Leuchten mit fest verbauten LEDs eine freiwillige Funktionsgarantie von 5 Jahren. Nähere Informationen finden Sie in der Garantieerklärung auf unserer Internetseite.
www.trio-leuchten.de

(NL) Als innovatieve en toekomstgerichte onderneming hechten wij veel belang aan de kwaliteit en betrouwbaarheid van onze producten. Alle artikelen uit ons assortiment worden onderworpen aan een strenge kwaliteitscontrole. Indien een product tegen de verwachting in niet foutloos functioneert of gebreken vertoont, bieden wij consumenten een vrijwillige fabrieksgarantie van 5 jaar op alle verlichtingstoestellen met permanent geïnstalleerde leds. Voor meer informatie, consulteer onze website.
www.trio-lighting.com

(RO) În calitate de companie inovatoare și orientată spre viitor punem mare accent pe calitatea și siguranța produselor noastre. Toate sortimentele noastre sunt supuse unui control riguros de calitate. Dacă un produs nu funcționează ireproșabil conform așteptărilor sau prezintă defect, vă oferim consumatorilor o garanție voluntară operațională de 5 ani pentru toate de iluminat cu LED-uri permanent instalate. Pentru mai multe detalii, va rugăm să vizitați site-ul.
www.trio-lighting.com

(GB) As an innovative, forward-thinking company, we place great value on the quality and reliability of our products. All the items in our range are subject to strict quality control. Should a product, contrary to expectations, show faulty function or defects, we provide consumers with a voluntary functional guarantee of 5 years for all LED luminaires with permanently installed LEDs. For further information, please visit our website.
www.trio-lighting.com

(ES) Como empresa innovadora y con la vista puesta en el futuro, le damos una gran importancia a la calidad y la fiabilidad de nuestros productos. Todos los artículos de nuestro catálogo están sujetos a un estricto control de calidad. En aquellos casos en los que, contrariamente a lo previsto, un producto presente algún defecto o un funcionamiento deficiente, ofrece a los usuarios una garantía funcional de 5 años en todos sus artículos de iluminación que cuentan con luces LED instaladas. Para más información, por favor visite nuestra página web.
www.trio-lighting.com

(FI) Innovatiivisena ja tulevaisuuteen katsovana yrityksenä kiinnitämme erityistä huomiota tuotteidemme laatuun ja luotettavuuteen. Kaikki valikoimamme tuotteet ovat tiukan laadunvalvonnan alaisia. Siltä varalta, että tuotteemme ei vastoin odotuksia toimikään moitteettomasti tai siinä on vikoja, myöntää kuluttajille vapaaehtoisen 5 vuoden toimintakuun kaikille pysyvästi asennetuille LED-valoille. Lisätietoja verkkosivuiltamme.
www.trio-lighting.com

(FR) En tant qu'entreprise innovante orientée vers l'avenir, nous accordons une grande importance à la qualité et à la fiabilité de nos produits. Tous les articles de notre gamme sont soumis à des contrôles-qualité stricts. Si contre toute attente un produit devait ne pas fonctionner correctement ou présenter des vices, nous offrons aux consommateurs une garantie une garantie fonctionnement de 5 ans pour tous les luminaires disposant de LED permanentes. Pour plus d'information, consultez notre site.
www.trio-lighting.com

(IT) In quanto azienda orientata all'innovazione e proiettata nel futuro, riponiamo un grande valore nella qualità e nell'affidabilità dei nostri prodotti. Tutti gli articoli del nostro assortimento vengono sottoposti a un rigido controllo della qualità. Nel caso in cui un prodotto dovesse presentare, contro ogni aspettativa, malfunzionamenti o difetti, offriamo ai consumatori una garanzia di funzionamento facoltativa di 5 anni per tutti gli apparecchi LED installati in modo permanente. Per ulteriori informazioni, vi preghiamo di visitare il nostro sito web.
www.trio-lighting.com

(PL) Jako innowacyjne i ukierunkowane na przyszłość przedsiębiorstwo przykładamy dużą wagę do jakości i niezawodności naszych produktów. Wszystkie artykuły z naszego asortymentu poddawane są surowej kontroli jakości. Jeśli produkt mimo oczekiwania nie działa prawidłowo lub jest uszkodzony, oferujemy dobrowolną 5-letnią gwarancję funkcjonalną na wszystkie oprawy oświetleniowe z zamontowanymi na stałe diodami LED. Na naszej stronie internetowej może Państwo uzyskać więcej informacji na ten temat.
www.trio-lighting.com

602

603

KONTAKTE

Contact · Contact · Contact · Contactar · Contatto · Contact · Yhteydenotto · Kontakt

TRIO Leuchten GmbH

Gut Nierhof 17
D-59757 Arnsberg
T +49 (0) 2931 9666-0
F +49 (0) 2931 9666-57
info@trio-leuchten.de
www.trio-leuchten.de

BADEN WÜRTTEMBERG, RHEINLAND-PFALZ UND SAARLAND

Antonio De Simone
T +49 (0) 151 5855222
antonio.desimone@trio-leuchten.de

BAYERN, HESSEN

Martin Kluge
T +49 (0) 171 7300330
martin.kluge@trio-leuchten.de

BERLIN, BRANDENBURG, MECKLENBURG-VORPOMMERN, SACHSEN, SACHSEN ANHALT, THÜRINGEN

Jörg Bumke
T +49 (0) 160 7406860
joerg.bumke@trio-leuchten.de

BREMEN, HAMBURG, NIEDERSACHSEN, SCHLESWIG-HOLSTEIN

Jens Gebers
T +49 (0) 170 1615227
jens.gebers@trio-leuchten.de

NORDRHEIN-WESTFALEN

Christian Teller
T +49 (0) 171 4521820
christian.teller@trio-leuchten.de

ÖSTERREICH

Wolfgang Melich
T +43 (0) 6605161228
wolfgang.melich@trio-leuchten.de

SCHWEIZ

TRIO Leuchten
T +49 (0) 2931 9666-0
info@trio-leuchten.de

 /trioleuchten

 @trio.lighting

 @trioleuchten

 @TRIO Lighting Group

 @trio Lighting



TRIO International GmbH

Gut Nierhof 17
D-59757 Arnsberg
T +49 (0) 2931 9666-587
F +49 (0) 2931 9666-56
info@trio-lighting.com
www.trio-lighting.com

FRANCE

Stéphane Papierny
Directeur Commercial France
info.france@trio-lighting.com

Jean Philippe Bailly

info.france@trio-lighting.com
*Agent exclusif pour les départements
60, 75 Nord, 92, 93 et 95*

Jean Barel / Thomas Wroz

info.france@trio-lighting.com
*Agent exclusif pour les départements
09, 12, 15, 16, 19, 24, 31, 32, 33, 40, 46,
47, 64, 65, 81, 82 et 87*

Jean Marc Beneforti

info.france@trio-lighting.com
*Agent exclusif pour les départements
2a et 2b*

Christophe Meulien

info.france@trio-lighting.com
*Agent exclusif pour les départements
04, 05, 06, 11, 13, 30, 34, 66, 83 et 84*

Sullivan Nicolas

info.france@trio-lighting.com
*Agent exclusif pour les départements
01, 03, 07, 21, 23, 26, 38, 39, 42,
43, 48, 63, 69, 71, 73 et 74*

Stéphane Riebel

info.france@trio-lighting.com
*Agent exclusif pour les départements
18, 45, 58, 75 Sud, 77, 78, 89, 91 et 94*

Michel Salamand

info.france@trio-lighting.com
*Agent exclusif pour les départements
14, 17, 22, 29, 35, 36, 37, 41, 44, 49, 50,
53, 56, 61, 72, 79, 85 et 86*

Elsa Seron

info.france@trio-lighting.com
*Agent exclusif pour les départements
27, 28 et 76*

Vincent Zaepffel

info.france@trio-lighting.com
*Commercial pour les départements
02, 08, 10, 25, 51, 52, 54, 55, 57, 59, 62,
67, 68, 70, 80, 88 et 90*

DANMARK

Jan Rantzau-Bartens
info.denmark@trio-lighting.com

NORDIC & BALTIC

TRIO Lighting Scandinavia Oy
Malmin raitti, rappu 17 B
00700 Helsinki
T +358 (0) 10 23 13 390
tls@trio-lighting.com

Our Scandinavian organisation represents TRIO
also in Sweden, Norway, Estonia, Latvia, Lithuania
and Iceland

ITALIA

TRIO Lighting Italia s.r.l
Via Isonzo 81
22066 Mariano Comense (CO)
commerciale@trio-lighting.com

ESPAÑA

TRIO Lighting Ibérica SL

C/ Can Lietget nº9 nave 9
Pol. Ind. Can Roqueta
08206 Sabadell
T +34 (0) 9 35 45 86 30
F +34 (0) 9 33 96 45 48
info.iberica@trio-lighting.com

GREAT BRITAIN

TRIO Lighting UK Ltd.

Unit 5, Hemmells Park Hemmells, Laindon
Essex
SS1s 6GF
T +44 (0) 12 68 88 95 95
F +44 (0) 12 68 88 95 96
sales@trio-lightinguk.com

NEDERLAND

Karl Stok / Bas Martin
info.nederland@trio-lighting.com

BELGIUM

Yves Van den Berghe
info.belgium@trio-lighting.com

ROMANIA

Gina Ionita / Loredana Barbu
info.romania@trio-lighting.com
loredana.barbu@trio-lighting.com

Lined writing area for page 606.

Lined writing area for page 607.

SAVE THE DATE



lichtforumnrw

Mitglied der Trägergesellschaft Lichtforum NRW e.V.
Member of the supporting organisation Lichtforum NRW e.V.

TRIO behält sich das Recht vor, zu jeder Zeit, notwendige Änderungen oder Aktualisierungen der in diesem Katalog enthaltenen Produkte vorzunehmen. · TRIO reserves the right to carry out any time, necessary changes or updates of the products in this catalogue. ·
TRIO se réserve le droit d'apporter à tout moment les modifications ou actualisations nécessaires aux produits dans ce catalogue. ·
TRIO behoudt zich het recht voor op ieder moment noodzakelijke wijzigingen of updates aan de producten in deze catalogus door te voeren. ·
TRIO se reserva , en todo momento, el derecho a realizar las modificaciones o actualizaciones que considere necesarias para cualquier producto de este catálogo. · TRIO si riserva il diritto di apportare, in qualunque momento, tutte le modifiche necessarie ai prodotti di questo catalogo. ·
TRIO-ul își rezervă dreptul de a face oricând orice modificări sau actualizări necesare pentru produsele din acest catalog. ·
TRIO pidättää oikeuden tehdä muutoksia tai päivittää tuotteita tässä luettelossa. ·
TRIO zastrzega sobie prawo do wprowadzania w dowolnym czasie zmian lub aktualizacji produktów zawartych w katalogu.